



Mobile Home Permit Worksheet

Installer: Tyler Brown License # IH1142500

Address of home 672 SW Newark Dr. Ft White, FL
 being installed

Manufacturer Champion Length x width 56X28

NOTE: *If home is a single wide fill out one half of the blocking plan*
If home is a triple or quad wide sketch in remainder of home
 I understand Lateral Arm Systems cannot be used on any home (new or used)
 where the sidewall ties exceed 5 ft 4 in.

Installer's initials TB

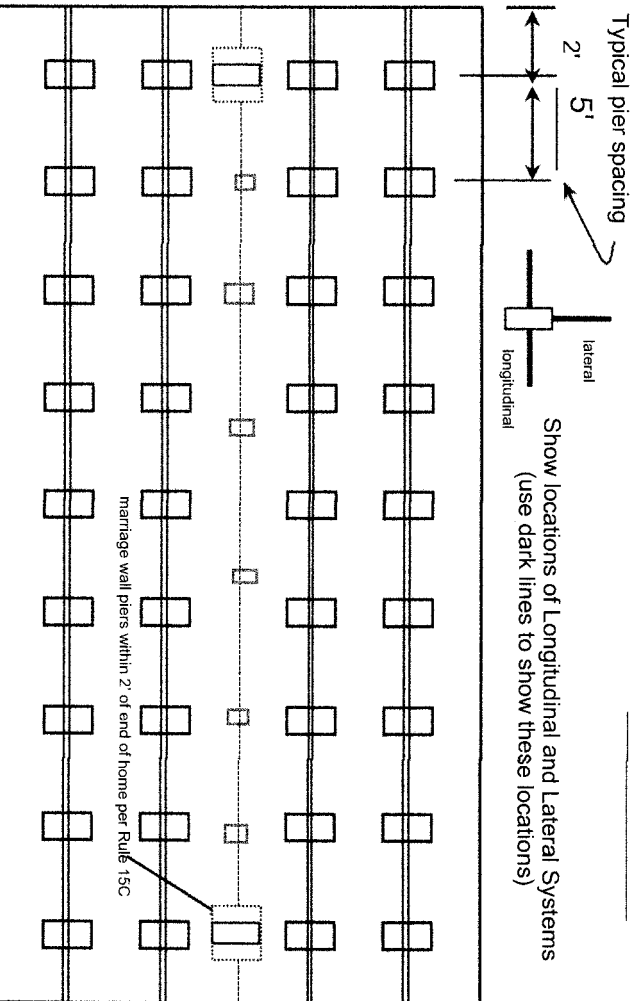

Permit Number: _____

Date: _____

New Home Used Home

Home installed to the Manufacturer's Installation Manual
 Home is installed in accordance with Rule 15-C

Single wide Wind Zone II Wind Zone III

Double wide Installation Decal # 126524

Triple/Quad Serial # _____

PIER SPACING TABLE FOR USED HOMES

Load bearing capacity	Footer size (sq in)	18 1/2" x 18 (342)	20" x 20" (400)	22" x 22" (484)*	24" x 24" (576)*	26" x 26" (676)
1000 psf	3'	4'	5'	6'	7'	8'
1500 psf	4'6"	6'	7'	8'	8'	8'
2000 psf	6'	8'	8'	8'	8'	8'
2500 psf	7'6"	8'	8'	8'	8'	8'
3000 psf	8'	8'	8'	8'	8'	8'
3500 psf	8'	8'	8'	8'	8'	8'

*Interpolated from Rule 15C-1 pier spacing table.

PIER PAD SIZES

I-beam pier pad size 17x25

Perimeter pier pad size 16x16

Other pier pad sizes (required by the mfg.) _____

Draw the approximate locations of marriage wall openings 4 foot or greater. Use this symbol to show the piers.

List all marriage wall openings greater than 4 foot and their pier pad sizes below.

Opening _____ Pier pad size _____

Every 8' 24X24

4 ft X _____ 5 ft _____

ANCHORS

FRAME TIES

within 2' of end of home spaced at 5' 4" oc X _____

TIEDOWN COMPONENTS

Longitudinal Stabilizing Device (LSD)

Manufacturer Oliver technology

Longitudinal Stabilizing Device w/ Lateral Arms

Manufacturer Oliver technology

OTHER TIES

Number _____

Sidewall _____

Longitudinal _____

Marriage Wall _____

Shear Wall _____



Mobile Home Permit Worksheet

POCKET PENETROMETER TEST

The pocket penetrometer tests are rounded down to 1500 psf or check here to declare 1000 lb. soil _____ without testing.

X _____ X _____ X _____

- #### POCKET PENETROMETER TESTING METHOD
- 1. Test the perimeter of the home at 6 locations.
 - 2. Take the reading at the depth of the footer.
 - 3. Using 500 lb. increments, take the lowest reading and round down to that increment.

X _____ X _____ X _____

TORQUE PROBE TEST

The results of the torque probe test is 295 inch pounds or check here if you are declaring 5' anchors without testing _____. A test showing 275 inch pounds or less will require 5' anchors.

Note: A state approved lateral arm system is being used and 4 ft. anchors are allowed at the sidewall locations. 1 understand 5' anchors are required at all centerline tie points where the torque test reading is 275 or less and where the mobile home manufacturer may require anchors with 4000 lb. holding capacity.

Installer's initials TB _____

ALL TESTS MUST BE PERFORMED BY A LICENSED INSTALLER

Installer Name Tyler Brown _____

Date Tested 11/18/25 _____

ELECTRICAL _____

Connect electrical conductors between multi-wide units, but not to the main power source. This includes the bonding between multi-wide units. Pg. 22

PLUMBING _____

Connect all sewer drains to an existing sewer tap or septic tank. Pg. 28

Connect all potable water supply piping to an existing water meter, water tap, or other independent water supply systems. Pg. 28

Permit Number: _____ Date: _____

Site Preparation

Debris and organic material removed Yes _____ No _____
Water drainage: Natural _____ Swale _____ Pad X _____ Other _____

Fastening multi wide units

Floor- Type Fastener: Lag Length: 6" Spacing: 16"
Walls- Type Fastener: Screw Length: 4" Spacing: 16"
Roof- Type Fastener: Lag Length: 6" Spacing: 16"

For used homes a min. 30 gauge, 8" wide, galvanized metal strip will be centered over the peak of the roof and fastened with galv. roofing nails at 2" on center on both sides of the centerline.

Gasket (weatherproofing requirement)

I understand a properly installed gasket is a requirement of all new and used homes and that condensation, mold, mildew and buckled marriage walls are a result of a poorly installed or no gasket being installed. I understand a strip of tape will not serve as a gasket. Installer's initials TB _____

Type gasket: Foam Installed:
Pg. 15 Between Floors Yes X
Between Walls Yes X
Bottom of ridge beam Yes X

Weatherproofing

The bottom board will be repaired and/or taped. Yes x Pg. 15
Siding on units is installed to manufacturer's specifications. Yes x
Fireplace chimney installed so as not to allow intrusion of rain water. Yes NA

Miscellaneous

Skirting to be installed.	Yes x	No _____	N/A _____
Dryer vent installed outside of skirting.	Yes x	No _____	N/A _____
Range downflow vent installed outside of skirting.	Yes _____	No _____	N/A x _____
Drain lines supported at 4' intervals.	Yes x	No _____	N/A _____
Electrical crossovers protected.	Yes x	No _____	N/A _____
Other:			

Installer verifies all information given with this permit worksheet is accurate and true based on the manufacturer's installation instructions and or Rule 15C-1 & 2

Installer's Signature Tyler Brown Date 11/18/25

Digitally signed by Tyler Brown
Date: 2025.11.18 14:10:02 -0500

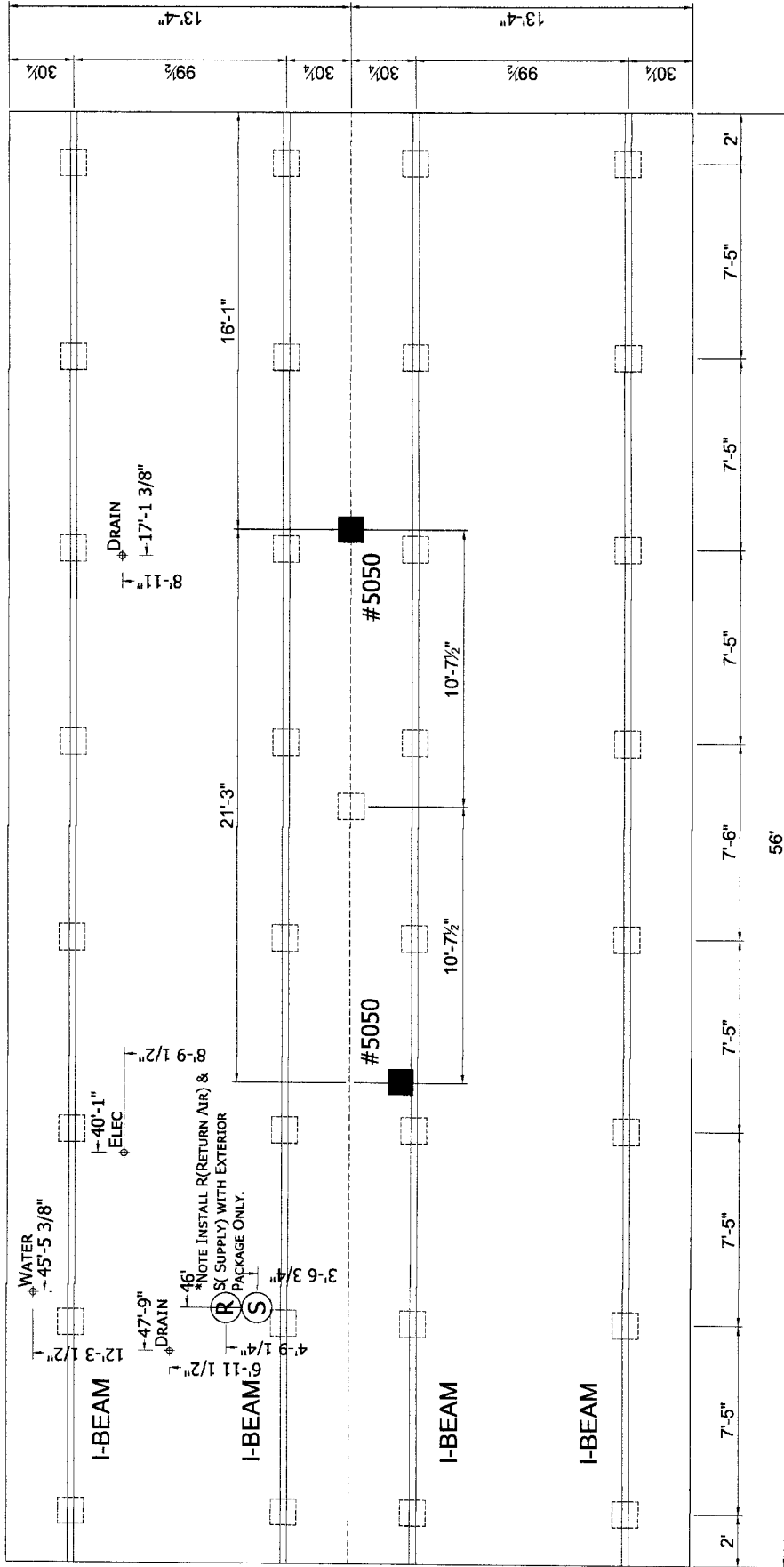

1) ALL EXTERIOR DOORS, BAY WINDOWS, RECESSED
 SIDEWALLS AND EXTERIOR WALL OPENINGS 48"
 OR GREATER. WILL REQUIRE BLOCKING ON EACH SIDE.

COLUMN BLOCKING
 SEE SOIL BEARING CAPACITY CHARTS FOR PAD SIZE
 BLOCKING

CHAMPION MANUFACTURED BEAUTIFULLY™ P.O. BOX 2097 HWY 100 EAST LAKE CITY, FL 32055	MODIFICATIONS	PROJECT: 261-RH4563C 56'-0" x 26'-8" 3 BD 2 BT	TITLE: PIER FOUNDATION PLAN FILENAME: RH4563C	SHEET: PR-101
	<small> PROPRIETARY AND CONFIDENTIAL THE INFORMATION CONTAINED HEREIN IS PROPRIETARY AND CONFIDENTIAL MATERIAL OF CHAMPION COPYRIGHT © 1992-2005 BY CHAMPION </small>			

License Number: IH / 1142500 / 1 Name: TYLER M BROWN	
Order # 6886 Label # 126524	Manufacturer
Homeowner: <i>Allen West</i>	Year Model
Address	Length & Width
City/State/Zip	Type Longitudinal System
Phone #	Type Lateral Arm System
Date Installed	New Home <input type="checkbox"/> Used Home <input type="checkbox"/>
Installed Wind Zone	Data Plate Wind Zone
Note	Permit #
	(Check Size of Home) Single <input type="checkbox"/> Double <input type="checkbox"/> Triple <input type="checkbox"/>
	HELD Label #
	Soil Bearing / PSF
	Torque Probe / in-lbs

STATE OF FLORIDA
INSTALLATION CERTIFICATION LABEL

126524

LABEL # _____ DATE OF INSTALLATION _____

TYLER M BROWN

NAME _____

IH / 1142500 / 1 6886

LICENSE # _____ ORDER # _____

CERTIFIES THAT THE INSTALLATION OF THIS MOBILE HOME IS IN ACCORDANCE WITH FLORIDA STATUTES 320.8249, 320.8325 AND RULES OF THE HIGHWAY SAFETY AND MOTOR VEHICLES

INSTRUCTIONS

PLEASE WRITE DATE OF INSTALLATION AND AFFIX LABEL NEXT TO HUD LABEL. USE PERMANENT INK PEN OR MARKER ONLY. COMPLETE INFORMATION ABOVE AND KEEP ON FILE FOR A MINIMUM OF 2 YEARS. YOU ARE REQUIRED TO PROVIDE COPIES WHEN REQUESTED.

OLIVER

Technologies, Inc.

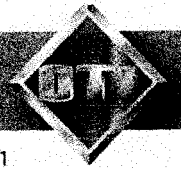

467 Swan Ave • Hohenwald, TN 38462 • (800) 284-7437 • www.olivertechnologies.com • Fax (931) 796-8811

**OLIVER TECHNOLOGIES, INC.
INSTALLATION INSTRUCTIONS FOR FLORIDA
MODEL 1101 "V" SERIES ALL STEEL FOUNDATION SYSTEM PAN & CONCRETE (revision 5/18)**

PATENT# 6634150 & OTHER PATENT PENDING

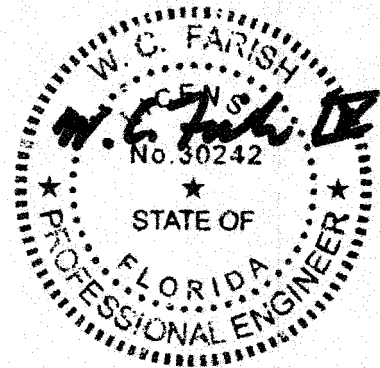

Aug 24, 2018



**OLIVER TECHNOLOGIES, INC.
FLORIDA INSTALLATION INSTRUCTIONS FOR THE
MODEL 1101 "V" SERIES ALL STEEL FOUNDATION SYSTEM**

**MODEL 1101 "V" (Steps 1-14)
LONGITUDINAL ONLY: Follow Steps 1-9
LATERAL ONLY: Follow Steps 1-3 and Steps 10-14
FOR CONCRETE APPLICATIONS: Follow Steps 15-18**

ENGINEERS STAMP

ENGINEERS STAMP

1. SPECIAL CIRCUMSTANCES: If the following conditions occur - **STOP! Contact Oliver Technologies at 1-800-284-7437 :**

- a) Pier height exceeds 48"
- b) length of home exceeds 76'
- c) Roof eaves exceed 16"
- d) Sidewall height exceed 96"
- e) Location is within 1500 feet of coast

INSTALLATION OF GROUND PAN

2. Remove weeds and debris in an approximate two foot square to expose firm soil for each ground pan (C).
3. Place ground pan (C) directly below chassis I-beam. Press or drive pan firmly into soil until flush or below soil then install pier per manufacturer's instructions or per Florida Regs.

SPECIAL NOTE: The longitudinal "V" brace system may also serve as a pier under the home and should be loaded as any other pier. It is recommended that after leveling piers, and one-third inch (1/3") before home is lowered completely on to piers, complete steps 4 through 9 below then remove jacks.

INSTALLATION OF LONGITUDINAL "V" BRACE SYSTEM (Model 1101 L "V")

NOTE: WHEN INSTALLING THE LONGITUDINAL SYSTEM ONLY, A MINIMUM OF 2 SYSTEMS PER FLOOR SECTION IS REQUIRED. SOIL TEST PROBE SHOULD BE USED TO DETERMINE CORRECT TYPE OF ANCHOR PER SOIL CLASSIFICATION. IF PROBE TEST READINGS ARE BETWEEN 175 & 275 A 5 FOOT ANCHOR MUST BE USED. IF PROBE TEST READINGS ARE BETWEEN 276 & 350 A 4 FOOT ANCHOR MAY BE USED. USE GROUND ANCHORS WITH DIAGONAL TIES AND STABILIZER PLATES EVERY 5'4". VERTICAL TIES ARE ALSO REQUIRED ON HOMES SUPPLIED WITH VERTICAL TIE CONNECTION POINTS (PER FLORIDA REG.).

4. Choose one of the approved longitudinal tube installations; either Diagram A or B. Then select the correct square tube (E) length from the diagram for appropriate pier height at support location or cut and drill 1.5" square tube to achieve appropriate length.

PIER HEIGHT (40° Min. - 45° Max.)	1.25" Tube Length	1.50" Tube Length
7 3/4" to 25"	22"	18"
24 3/4" to 32 1/4"	32"	18"
33" to 41"	44"	18"
40" to 48"	54"	18"

Diagram A

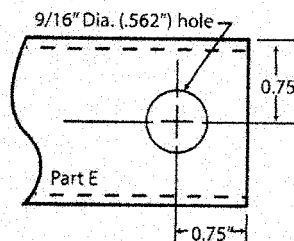

PIER HEIGHT (40° Min. - 60° Max.)	1.50" Tube Length
14" to 18"	20"
18" to 25"	28"
24" to 35"	39"
30" to 40"	44"
36" to 48"	54"

Diagram B

5. Install (2) of the 1.50" square tubes (E) into the "U" bracket (J), insert carriage bolt and leave nut loose for final adjustment.
6. Place I-beam connector (F) loosely on the bottom flange of the I-beam.
7. (For Diagram A installation) Slide the selected 1.25" tube (E) into a 1.50" tube (E) and attach to I-beam connectors (F) and fasten loosely with bolt and nut. (For Diagram B installation) Attach the selected 1.5" tubes (E) to the I-beam connectors (F) and fasten loosely with bolts and nuts.
8. Repeat steps 6 through 7 to create the "V" pattern of the square tubes loosely in place.
9. Using standard hand tools tighten all nuts and bolts. (For Diagram A installation only, secure 1.25" and 1.50" tubes using four(4) 1/4"-14 x 3/4" self-tapping screws in pre-drilled holes.)

INSTALLATION OF LATERAL TELESCOPING TRANSVERSE ARM SYSTEM (Model 1101 T "V")

THE MODEL 1101 "V" (LONGITUDINAL & LATERAL PROTECTION) ELIMINATES THE NEED FOR STABILIZER PLATES & FRAME TIES.

NOTE: THE USE OF THIS SYSTEM REQUIRES VERTICAL TIES SPACED AT 5'4".

FOUR FOOT (4') GROUND ANCHOR MAY BE USED EXCEPT WHERE THE HOME MANUFACTURER SPECIFIES DIFFERENT.

10. Install remaining vertical tie-down straps and 4' ground anchors per home manufacturer's instructions. NOTE: Centerline anchors to be sized according to soil torque condition. Any manufacturer's specifications for sidewall anchor loads in excess of 4,000 lbs. require a 5' anchor per Florida Code.
11. Select the correct square tube brace (H) length for set-up lateral transverse at support location. The lengths come in either 60" or 72" lengths. (With the 1.50" tube as the bottom tube, and the 1.25" tube as the inserted tube.)
12. Install the 1.50" transverse brace (H) to the ground pan connector (D) with bolt and nut.
13. Slide 1.25" transverse brace into the 1.50" brace and attach to adjacent I-beam connector (I) with bolt and nut.
14. Secure 1.50" transverse arm to 1.25" transverse arm using four (4) 1/4" - 14 x 3/4" self-tapping screws in pre-drilled holes.

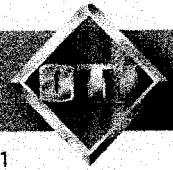

INSTALLATION USING CONCRETE RUNNER/ FOOTER

15. A concrete runner, footer or slab may be used in place of the steel ground pan.
 - a) The concrete shall be minimum 2500 psi mix
 - b) A concrete runner may be either longitudinal or transverse, and must be a minimum of 8" deep with a minimum width of 16 inches longitudinally or 18 inches transverse to allow proper distance between the concrete bolt and the edge of the concrete (see below).
 - c) Footers must have minimum surface area of 441 sq. in. (i.e. 21" square), and must be a minimum of 8" deep.
 - d) If a full slab is used, the depth must be a 4" minimum. Special inspection of the system bracket installation is not required. Footers must allow for at least 4" from the concrete bolt to the edge of the concrete.

NOTE: The bottom of all footings, pads, slabs and runners must be per local jurisdiction.



LONGITUDINAL: (Model 1101 LC "V")

16. When using Part# 1101-W-CPCA (wetset) simply install the bracket in runner/footer **OR** When installing in cured concrete use Part# 101-D-CPCA (dryset). The 1101 (dryset) CA bracket is attached to the concrete using (2) 5/8"x3" concrete wedge bolts (Simpson part # S162300H 5/8" X 3" or Powers equivalent). Place the CA bracket in desired location. Mark bolt hole locations, then using a 5/8" diameter masonry bit, drill a hole to a minimum depth of 3". Make sure all dust and concrete is blown out of the holes. Place wedge bolts into drilled holes, then place 1101 (dry set) CA bracket onto wedge bolts and start wedge bolt nuts. Take a hammer and lightly drive the wedge bolt down by hitting the nut (making sure not to hit the top of threads on bolt). The sleeve of concrete wedge bolt needs to be at or below the top of concrete. Complete by tightening nuts.

LATERAL: (Model 1101 TC "V")

17. For wet set (part # 1101-W-TACA) installation simply install the anchor bolt into runner/footer. For dry set installation (part # 1101-D-TACA) mark bolt hole locations, then using a 5/8" diam. masonry bit, drill a hole to a minimum depth of 3". Make sure all dust and concrete is blown out of the hole. Place wedge bolts (Simpson part #S162300H 5/8" X 3" or Powers equivalent) into (D) concrete dry transverse connector and into drilled hole. If needed, take a hammer and lightly drive the wedge bolts down by hitting the nut (making sure not to hit the top of threads on bolt), then remove the nut. The sleeve of concrete wedge bolt needs to be at or below the top of concrete.
18. When using part# 1101 CVW (wetset) or 1101 CVD (dryset), install per steps 17 & 18.

Notes:

1. LENGTH OF HOUSE IS THE ACTUAL BOX SIZE
2.  = LOCATION OF TRANSVERSE BRACING ONLY
3.  = LOCATION OF LONGITUDINAL BRACING ONLY
4.  = TRANSVERSE AND LONGITUDINAL LOCATIONS

ALL WIDTHS AND LENGTHS UP TO 52'

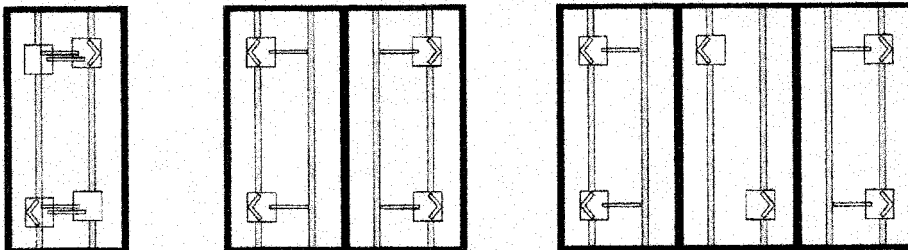

ALL WIDTHS AND LENGTHS OVER 52' TO 80"

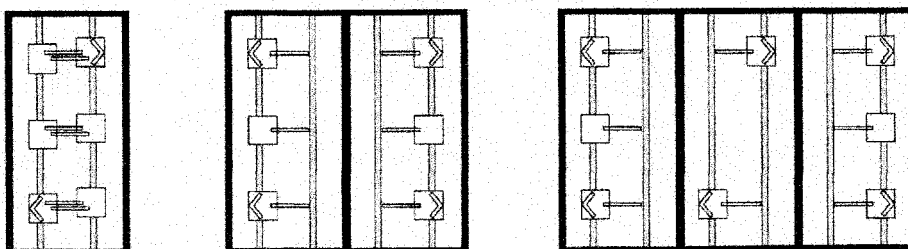

HOMES WITH 5/12 ROOF PITCH REQUIRE: PER FLORIDA REGULATIONS
6 systems for home lengths up to 52' and 8 systems for homes over 52' and up 80'.

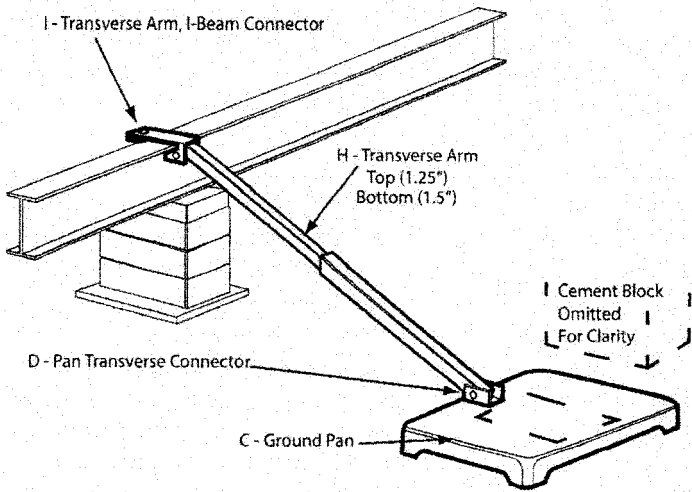

Model # 1101 T "V"

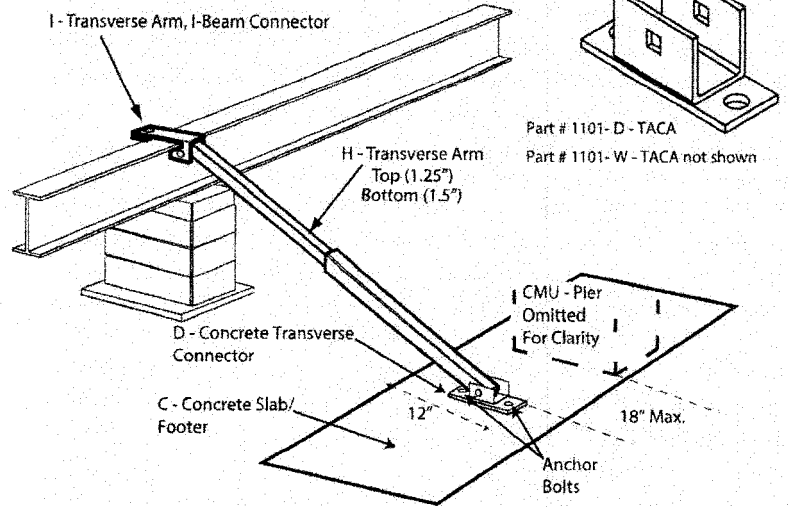

Model # 1101 TC "V"

Florida approved 4' ground anchors may be used in all locations except where home manufacturers specifications for sidewall straps are in excess of 4,000 lbs. These locations require a 5' anchor. Per Florida code.

C = GROUND PAN / CONCRETE FOOTER OR RUNNER

D = GROUND PAN / CONCRETE U BRACKETS TRANSVERSE CONNECTOR (connects with grade 5 - 1/2" x 2" 1/2" carriage bolt and nut)

E = TELESCOPING V BRACE TUBE ASSEMBLY (1.5" TUBE BOTTOM AND 1.25" TUBE INSERT) OR 1.5" TUBE

F = "V" BRACE I-BEAM CONNECTOR ASSEMBLY

H = TELESCOPING TRANSVERSE ARM ASSEMBLY

I = TRANSVERSE ARM I-BEAM CONNECTOR (connects with grade 5 - 1/2" x 2" 1/2" carriage bolt and nut)

J = V PAN BRACKET (connects with grade 5 - 1/2" x 2" 1/2" carriage bolt and nut)

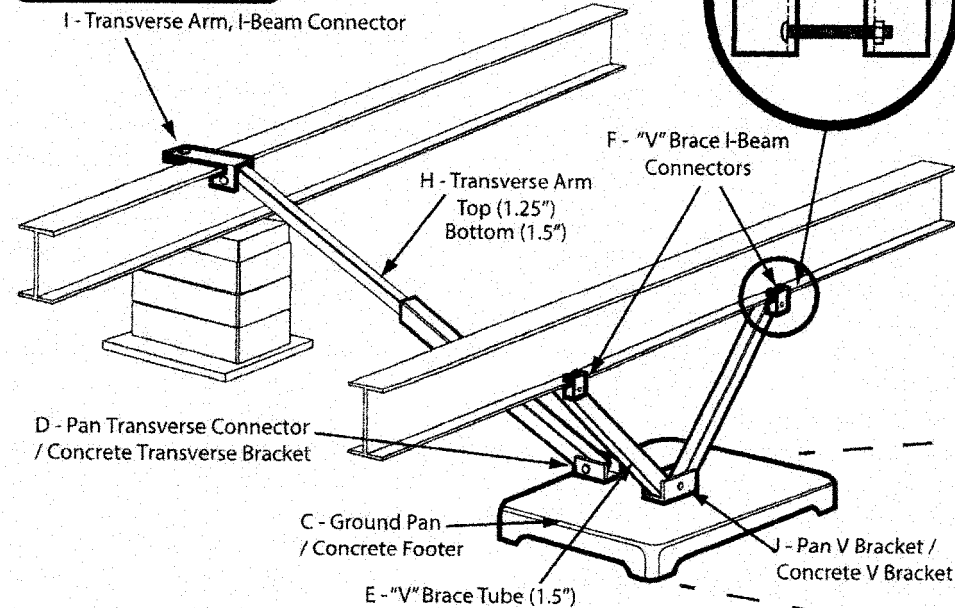
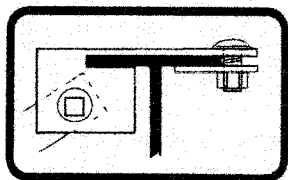

Model # 1101 "V"

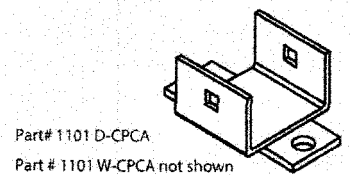

Part# 1101 D-CPCA
Part # 1101 W-CPCA not shown

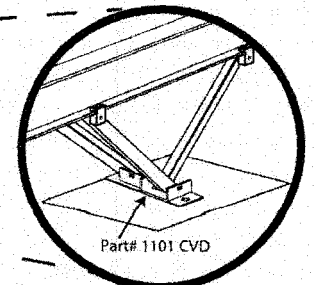

Model # 1101 C "V"



State of Florida
DEPARTMENT OF
HIGHWAY SAFETY AND MOTOR VEHICLES

TALLAHASSEE, FLORIDA 32399-0500

June 17, 2002

FRED O. DICKINSON, III
 Executive Director

Mr. Lon Larson, General Manager
 Manufactured Housing Foundation Systems, Inc.
 A Division of Oliver Technologies
 Post Office Box 9
 Hohenwald, Tennessee 38462

Dear Mr. Larson:

We wish to acknowledge receipt of your specifications and test results certifying that your 1055-20 Flex Free ABS Plastic Pad listed below complies with the specifications and regulations set by the Department of Highway Safety and Motor Vehicles, Rules 15C-1.0105, 15C-1.0107 and 15C-1.0108, Florida Administrative Code.

Based on the information submitted to this bureau, the following product is listed for sale and use in Florida when the installation instructions showing the way the pads were tested, are provided.

<u>MODEL #</u>	<u>IDENTIFICATION</u>	<u>DESCRIPTION</u>	<u>AREA</u>
1055-20	Flex Free ABS Plastic Pad	23.25" x 31.25"	4.698 sq. ft.

MAXIMUM PIER LOADS IN POUNDS BASED ON SOIL VALUES

PAD CONFIGURATION	PAD AREA	LOAD
Pad 1	4.698 sq. ft.	1000 lb. soil - 4,698 2000 lb. soil - 9,396

- NOTES: 1) INSTALLER IS RESPONSIBLE FOR DETERMINING SOIL BEARING CAPACITY.
 2) THE PAD WAS TESTED FOR SINGLE AND DOUBLE BLOCK CONFIGURATION.
 3) 8,000 LB. LOAD AND ABOVE REQUIRE DOUBLE BLOCK CONFIGURATION.

If you have any questions, please advise at (407) 623-1340.

Sincerely,

Phil Bergelt, Program Manager
 Bureau of Motor Home and
 Recreational Vehicle Construction
 Division of Motor Vehicles

PRB:srb



State of Florida
DEPARTMENT OF
HIGHWAY SAFETY AND MOTOR VEHICLES

TALLAHASSEE, FLORIDA 32399-0500

FRED O. DICKINSON, III
Executive Director

October 27, 1999

Mr. Lon Larson, General Manager
Manufactured Housing Foundation Systems
A Division of Oliver Technologies
562 Glenheather Drive
San Marcos, California 92069

Dear Mr. Larson:

We wish to acknowledge receipt of your print specifications and test results certifying your Adjustable Outrigger listed below complies with the Federal Manufactured Construction and Safety Standards, § 3280.305 and § 3280.401 and with the rules and regulations set forth by the Department of Highway Safety and Motor Vehicles, Florida Administrative Rule Code 15C-1.01105.

Based on the information submitted to the bureau, the following product is listed for use in Florida when the installation instructions showing the way the outrigger was tested, are provided.

MODEL #	IDENTIFICATION	DESCRIPTION
1055-11	Adjustable Outrigger	Bracket, Pipe, & Screw Adjustment

NOTE: The outrigger was tested on September 19, 1999, for an allowable load of 1700 pounds.

If you have any questions, please advise at (850) 413-7600.

Sincerely,

Phil Bergelt, Program Manager
Bureau of Mobile Home and
Recreational Vehicle Construction
Division of Motor Vehicles

PB:bsc

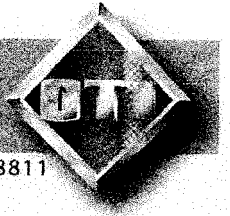

OLIVER TECHNOLOGIES, INC. Adjustable Outrigger Installation Instructions MODEL # 1055-11

1. Locate the floor joist that requires support.
2. Mark the I-Beam directly under the floor joist to align the outrigger.
3. Adjust the nut on the threaded rod so it clears the frame flange for easy adjustment.
4. Set the threaded rod in the pipe and against the frame.
5. Set the notched end of the thrust bracket into the end of the pipe and secure it with 5 # 12 x 2" screws to the floor joist. The thrust bracket should be approximately 6" from the outside rim joist.
6. Bottom board and insulation should be between the bracket and the joist.
7. For minor adjustments align the door and window openings by tightening or loosening the adjustment nut. For all other adjustments use a hydraulic jack to raise the floor joist before installation of the outrigger.

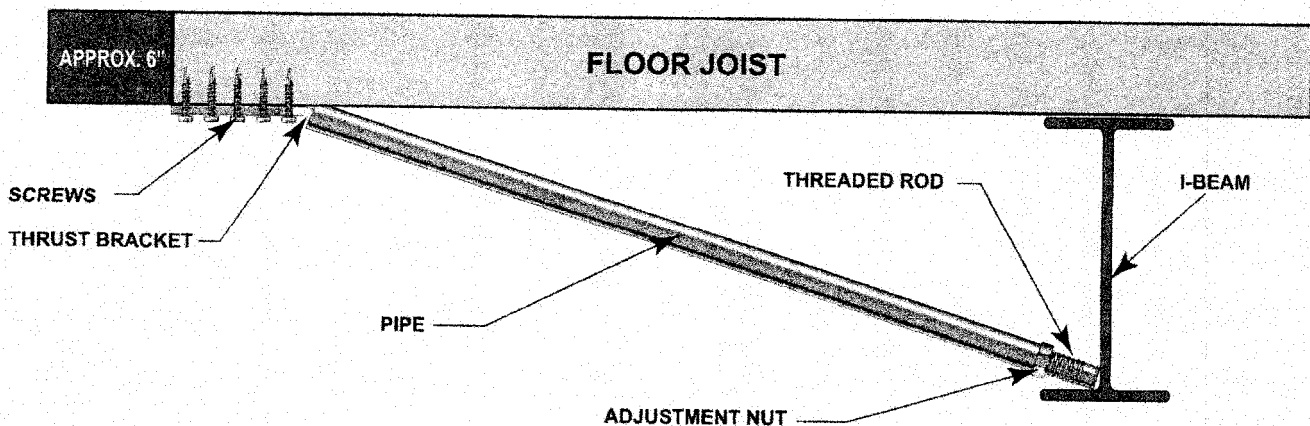

NOTES:

*REMOVE OUTRIGGER WHEN HOME IS BEING TRANSPORTED

*SPECIFY WIDTH OF HOME WHEN ORDERING OUTRIGGER. PIPE MAY BE CUT TO FIT

*THE ADJUSTABLE OUTRIGGERS SHALL ONLY BE USED ON HOMES FOR OPENINGS UP TO:

6' ON 20 LB ROOF LOAD

4' ON 30 LB ROOF LOAD

3' ON 40 LB ROOF LOAD

*WHEN ADJUSTABLE OUTRIGGERS ARE USED FOR DOOR AND WINDOW SUPPORTS, THEY MUST BE INSTALLED ON THE CLOSEST FLOOR JOIST UP TO 16" FROM THE OUTSIDE EDGE OF THE OPENING

*DO NOT INSTALL ADJUSTABLE OUTRIGGER AT LOCATIONS WHERE THE HOME MANUFACTURER INDICATES A LOAD IN EXCESS OF 1,700 LBS.

*THE ADJUSTABLE OUTRIGGER MUST BE USED ON A MINIMUM 10" I-BEAM AND BE PLACED WITHIN 4' OF A MAIN FRAME SUPPORT PIER OR FRAME CROSSMEMBER.

Listing # 1055-11

Patent # 6.334.279

**For use on all Mobile and Manufactured Homes, including
HUD approved Homes and Modular Building
Patent #5503500 and other patents pending**

GENERAL INSTRUCTIONS:

1. All pads are to be installed flat side down, ribbed side up.
2. The ground under the pads should be leveled as smooth as possible with all vegetation and debris removed. Pads to be placed on evenly compacted soil, at or below the frost line unless otherwise protected from frost by controlling the temperature and/ or moisture content of the soil underneath the home.
3. Pier & pad placement will be determined by the manufactured homes' written set-up instructions or any local or state codes.
4. Center blocks on ABS pad and complete pier.
5. The open cells between the ribbing on the upper side of the pads may be filled with soil or sand after installation to prevent any accumulation of stagnant water in the pads.
6. A pocket penetrometer may be used to determine the unconfined compressive strength of the soil. If no soil testing equipment is available – use an assumed soil value of 1000 lbs. / square foot.

NOTES:

1. All pad sizes shown are nominal dimensions and may vary up to 1/8".
2. The maximum deflection in a single pad is 5/8" measured from the highest point to the lowest point of the top face.
(NOTE: Actual test results were less than 5/8")
3. Pad loads are the same when using single stack or double stack blocks.
4. The maximum load at any intermediate soil value may be interpolated between the next lower and next higher soil values given in the table below.
5. Any ABS pad configuration may be used to replace a home manufacturer's recommended concrete or wood base pad.
6. Steel Piers: All pads are tested with steel piers on 1000 PSF soil density unless otherwise noted. If required, attach with 2" #12 x 1/2" hex tech screws. Minimum Pier Base 7 1/4". Multi-Pad configurations require a minimum 9 1/4" pier base.
7. Available pads tested on 2000 PSF soil capacity using steel piers are: ID #1055-14, 1055-9, 1055-7 and 1055-13.
8. If soil capacities exceed 3000 psf, use the 3000 psf soil values from the table.
9. Any pad may be stacked directly on top of an identical pad. The second pad should also be installed flat side down. Such a configuration provides the same allowable load capacity as the single pad.

PAD SIZE	ID NO.	PAD AREA	1000 PSF	1500 PSF	2000 PSF	2500 PSF	3000 PSF
Oval 16" x 18.5"	1055-23	288 sq. in.	2000 lbs.	3000 lbs.	4000 lbs.	5000 lbs.	6000 lbs.
Oval 17" x 22"	1055-16	360 sq. in.	2500 lbs.	3750 lbs.	5000 lbs.	6250 lbs.	7500 lbs.
Oval 17.5" x 22.5"	1055-21	384 sq. in.	2667 lbs.	4000 lbs.	5334 lbs.	6667 lbs.	8000 lbs. *
Oval 17.5" x 25.5"	1055-17	432 sq. in.	3000 lbs.	4500 lbs.	6000 lbs.	7500 lbs.	9000 lbs. *
Oval 21" x 29"	1055-22	576 sq. in.	4000 lbs.	6000 lbs.	8000 lbs. *	10000 lbs. *	12000 lbs. *
Oval 23.25" x 31.25"	1055-20	675 sq. in.	4688 lbs.	7032 lbs.	9376 lbs. *	11720 lbs. *	14064 lbs. *

PAD SIZE	ID NO.	PAD AREA	1000 PSF	1500 PSF	2000 PSF	2500 PSF	3000 PSF
Square 16" x 16"	1055-14	256 sq. in.	1778 lbs.	2664 lbs.	3556 lbs.	4445 lbs.	5333 lbs.
Square 18.5" x 18.5"	1055-9	342 sq. in.	2375 lbs.	3550 lbs.	4750 lbs.	5935 lbs.	7100 lbs.
Square 20" x 20"	1055-7	400 sq. in.	2750 lbs.	4125 lbs.	5500 lbs.	6875 lbs.	8250 lbs. *
Square 24" x 24"	1055-13	576 sq. in.	4000 lbs.	6000 lbs.	8000 lbs. *	8000 lbs. *	8000 lbs. *
Square 24" x 24"	1055-26	576 sq. in.	4000 lbs.	6000 lbs.	8000 lbs. *	10000 lbs. *	12000 lbs. *

* Indicates that Piers are required to be double blocked.
EXAMPLE: 16' x 80' section (Alabama only)

PAD SIZE	1000 PSF	2000 PSF
Oval 16" x 18.5"	3'0"	6'0"
Oval 17" x 22"	3'9"	7'6"
Oval 17.5" x 22.5"	4'0"	8'0"
Oval 17.5" x 25.5"	4'5"	8'0"
Oval 21" x 29"	6'0"	8'0"

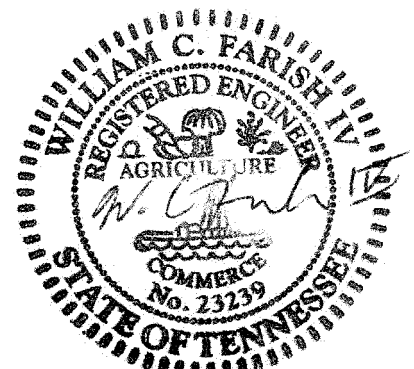
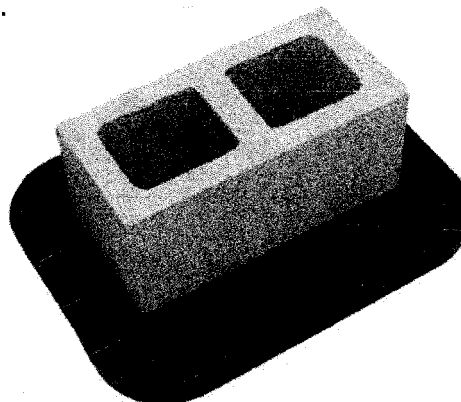

Jul 14, 2020

Multi-Pad Configurations

ABS Pad Types			8" Cell Block	Soil Bearing Value	Maximum Load	
Oval 16" x 18.5" Pad	2.00 Square Feet	ID # 1055-23	32" x 18.5" Pad Configuration	Single Stack	1000 lbs. / sq. ft.	4000 lbs.
Oval 32" x 18.5" Pad Configuration (03)	4.00 Square Feet	ID # 1055-16		Double Stack	2000 lbs. / sq. ft.	8000 lbs. *
Oval 17" x 22" Pad	2.50 Square Feet		ID # 1055-17	34" x 22" Pad Configuration	Single Stack	1000 lbs. / sq. ft.
Oval 34" x 22" Pad Configuration (03)	5.00 Square Feet	Double Stack			2000 lbs. / sq. ft.	10000 lbs. *
Oval 17.5" x 25.5" Pad	3.00 Square Feet	ID # 1055-17	35" x 25.5" Pad Configuration	Single Stack	1000 lbs. / sq. ft.	6000 lbs.
Oval 35" x 25.5" Pad Configuration (03)	6.00 Square Feet			Double Stack	2000 lbs. / sq. ft.	12000 lbs. *

*Concrete blocks are only rated at 8000 pounds, 8001 pounds and higher must be double stacked.

PAD ASSEMBLY

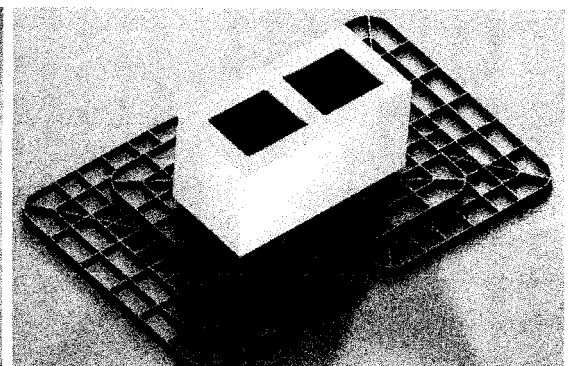
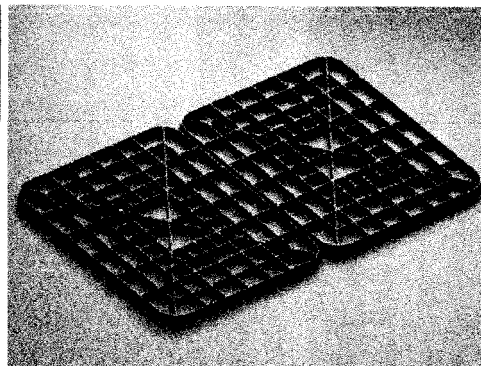
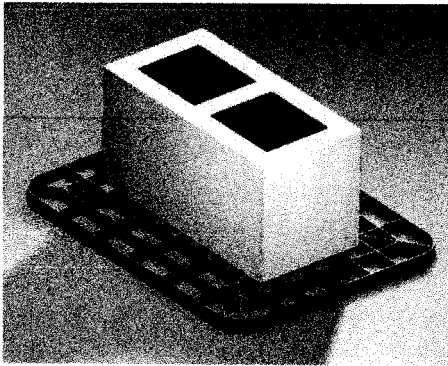

STEP 1 - 17" x 22" ABS Pad **STEP 2 - (2) 17" x 22" ABS PADS**
(34" x 22" Configuration)

STEP 3 - Complete Assembly
34" x 22" Multi-pad Configuration

NOTES:

1. General instructions (on reverse) apply to all multi – pad configurations.
2. The 32" x 18.5" pad configuration is formed by using (3) 16" x 18.5" ABS Pads. Place (2) 16" x 18.5" side by side, and place (1) 16" x 18.5" on top, laid in the opposite direction to the bottom pads.
3. The 34" x 22" pad configuration is formed by using (3) 17" x 22" ABS Pads. Place (2) 17" x 22" pads side by side, and (1) 17" x 22" pad on top. The top pad is laid in the opposite direction as the bottom pads.
4. The 35" x 25.5" pad configuration is formed by using (3) 17.5" x 25.5" ABS Pads. Place (2) 17.5" x 25.5" pads side by side, and (1) 17.5" x 25.5" pad on top. The top pad is laid in the opposite direction to the bottom pads.

STATE SPECIFIC NOTES:

TEXAS: 17.5" x 22.5" ID #1055-21 and 23.25" x 31.25" ID #1055-20 may not be installed in the State of Texas. ID#1055-26 may not be used in conjunction with metal piers.

CALIFORNIA: Use an assumed value of 1000 lb/sq. ft. unless engineering and calculations are provided.

ALABAMA : For the State of Alabama all ABS pads shall not have more than 3/8" deflection. See chart on page one for details on correct installation in Alabama. The 23.25" x 31.25" ID#1055-20 may not be installed in the State of Alabama.

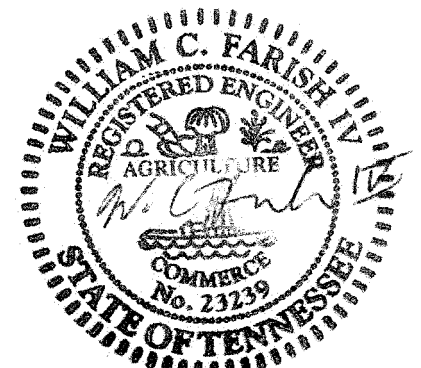

Jul 14, 2020

40" x 40" STEPS

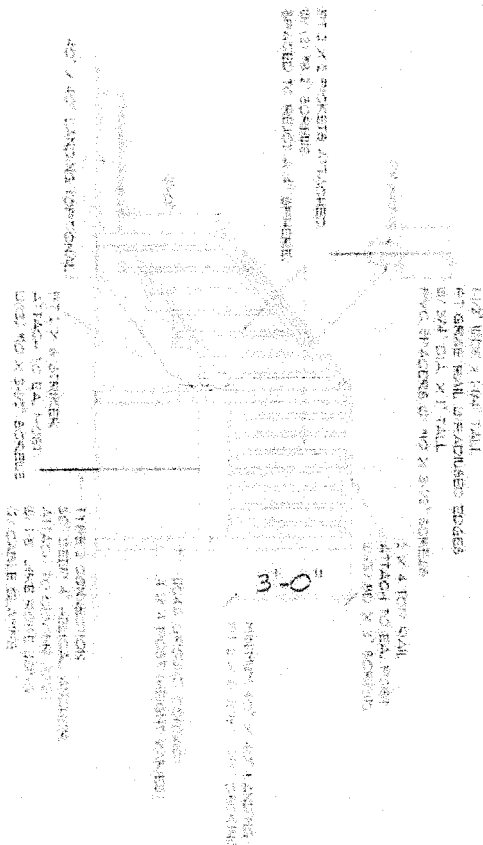

NOTES:

1. STEPS HAVE A MIN. 40" X 40" LANDING
2. STEPS HAVE A RISER HEIGHT OF BETWEEN 6.75" TO 7.75"
3. HANDRAIL HEIGHT 36"
4. STEPS TO HAVE MIN. 10" TREAD DEPTH.
5. PICKETS TO BE SPACED TO REJECT A 4" SPHERE.
6. STEPS TO MEET TREAD TO RISER RATIO- 2 RISES + 1 TREAD = 24" - 25"
7. FLIGHT OF STAIRS NOT TO HAVE VERTICAL RISES GREATER THAN 12' BETWEEN LANDINGS.

Ray E. Resner

RAY E. RESNER P.E. #31724
 P.O. BOX 3
 BULLMANEE, FL. 32607
 351-318-1382

STEP RITE SOLUTIONS

PHONE:
 FAX:
 MOBILE:



DRAWN BY: DKF
 SCALE: 3/4" = 1'-0"
 DATE: Wednesday, November 6, 2024

PAGE:
 1/2
 40 INCH STEPS

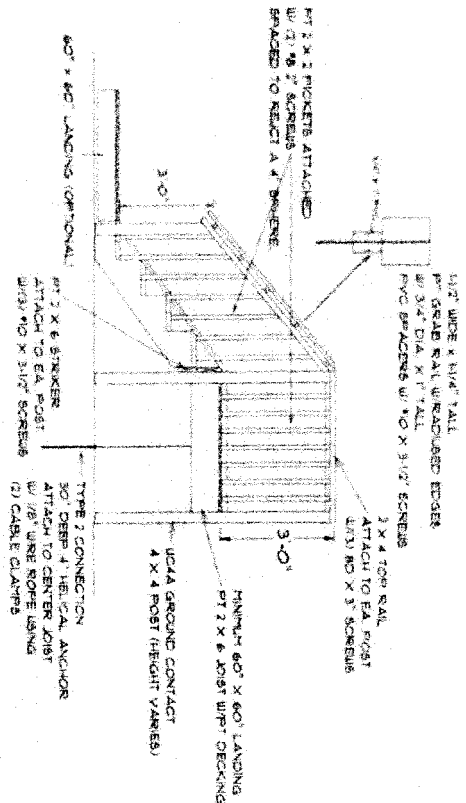

- NOTES:
1. STEPS HAVE A MIN. 60" X 60" LANDING
 2. STEPS HAVE A RISER HEIGHT OF BETWEEN 6.75" TO 1.75"
 3. HANDRAIL HEIGHT 36"
 4. STEPS TO HAVE MIN. 10" TREAD DEPTH.
 5. PICKETS TO BE SPACED TO REJECT A 4" SPHERE
 6. STEPS TO MEET TREAD TO RISER RATIO - 2 RISES + 1 TREAD = 24" - 25"
1. FLIGHT OF STAIRS NOT TO HAVE VERTICAL RISES GREATER THAN 12' BETWEEN LANDINGS.

60" X 60" STEPS

Ray E. Sinner
 11/11/24
 PROFESSIONAL ENGINEER
 STATE OF FLORIDA
 LICENSE NO. 12587

RAY E. SINNER, P.E.
 PO BOX 3
 GUNNANE, FL 32692
 352-38-1356

STEP RITE SOLUTIONS PHONE: FAX: MOBILE:	SECTION LETTER A PAGE NUMBERS 11	DRAWN BY: DKF	PAGE
		SCALE 3/4" = 1'-0"	2 / 2
		DATE Wednesday, November 6, 2024	60 INCH STEPS

INSTALLATION VERTICAL SKIRTING (WALL SECTION)

1. Top back rail will be screwed to bottom of home with 3/4" screw every 16".
2. Bottom track will be spiked every 16" with 7" galvanized nail.
3. Each panel must be installed with required screws. Screws installed in each panel top and bottom every 16".
4. Access allowed by any panel.
5. Any part of home over 36" from bottom of home to ground will require metal bracing with cross brace. (Bracing requirements 2 x 3 metal brace attached to bottom of home with 3/4" screws and buried in the ground every 4' with cross brace.)

