



Mobile Home Permit Worksheet

Installer: Kyle Johnson License # IH11266571

Address of home being installed 3859 SW Old Wire Road Ft White

Manufacturer Destiny Length x width 66X32

NOTE: If home is a single wide fill out one half of the blocking plan
If home is a triple or quad wide sketch in remainder of home
I understand Lateral Arm Systems cannot be used on any home (new or used) where the sidewall ties exceed 5 ft 4 in.

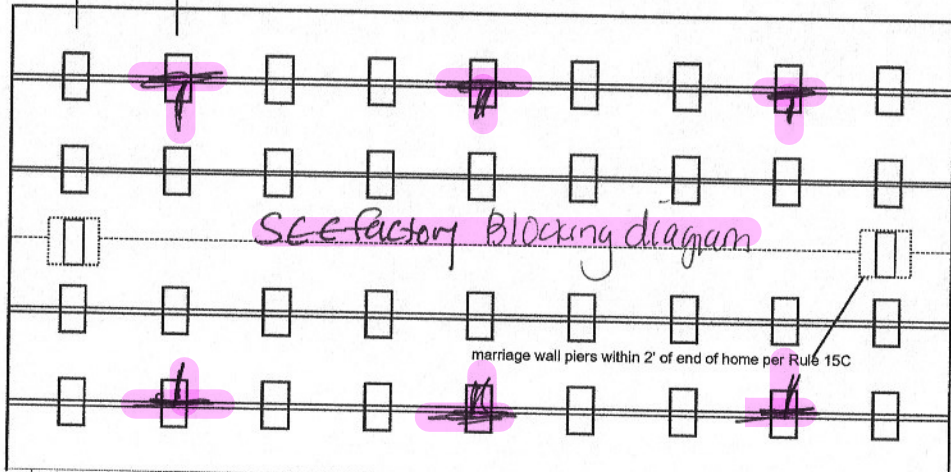
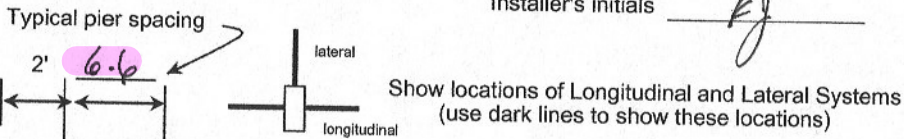

Permit Number: _____ Date: _____

New Home Used Home

Home installed to the Manufacturer's Installation Manual
Home is installed in accordance with Rule 15-C

Single wide Wind Zone II Wind Zone III

Double wide Installation Decal # 129888

Triple/Quad Serial # _____

PIER SPACING TABLE FOR USED HOMES

| Load bearing capacity | Footer size (sq in) | 16" x 16" (256) | 18 1/2" x 18 1/2" (342) | 20" x 20" (400) | 22" x 22" (484)* | 24" X 24" (576)* | 26" x 26" (676) |
|-----------------------|---------------------|-----------------|-------------------------|-----------------|------------------|------------------|-----------------|
| 1000 psf | 3' | 3' | 4' | 5' | 6' | 7' | 8' |
| 1500 psf | 4'6" | 4'6" | 6' | 7' | 8' | 8' | 8' |
| 2000 psf | 6' | 6' | 8' | 8' | 8' | 8' | 8' |
| 2500 psf | 7'6" | 7'6" | 8' | 8' | 8' | 8' | 8' |
| 3000 psf | 8' | 8' | 8' | 8' | 8' | 8' | 8' |
| 3500 psf | 8' | 8' | 8' | 8' | 8' | 8' | 8' |

*interpolated from Rule 15C-1 pier spacing table.

PIER PAD SIZES

I-beam pier pad size 23.5 x 31.5

Perimeter pier pad size 17.5 x 26.5
Oliver 1055-11 orthog bar

Other pier pad sizes _____
(required by the mfg.)

Draw the approximate locations of marriage wall openings 4 foot or greater. Use this symbol to show the piers.

List all marriage wall openings greater than 4 foot and their pier pad sizes below.

Opening _____ Pier pad size _____

SEE FACTORY BLOCKING DIAGRAM

TIEDOWN COMPONENTS

Longitudinal Stabilizing Device (LSD)

Manufacturer _____

Longitudinal Stabilizing Device w/ Lateral Arms

Manufacturer OLIVER

POPULAR PAD SIZES

| Pad Size | Sq In |
|-------------------|-------|
| 16 x 16 | 256 |
| 16 x 18 | 288 |
| 18.5 x 18.5 | 342 |
| 16 x 22.5 | 360 |
| 17 x 22 | 374 |
| 13 1/4 x 26 1/4 | 348 |
| 20 x 20 | 400 |
| 17 3/16 x 25 3/16 | 441 |
| 17 1/2 x 25 1/2 | 446 |
| 24 x 24 | 576 |
| 26 x 26 | 676 |

4 ft 5 ft

ANCHORS

FRAME TIES

within 2' of end of home spaced at 5' 4" oc

OTHER TIES

| | Number |
|---------------|-----------|
| Sidewall | <u>30</u> |
| Longitudinal | <u>0</u> |
| Marriage Wall | <u>6</u> |
| Shear Wall | <u>0</u> |



Mobile Home Permit Worksheet

POCKET PENETROMETER TEST

The pocket penetrometer tests are rounded down to _____ psf or check here to declare 1000 lb. soil without testing.

X _____ X _____ X _____

POCKET PENETROMETER TESTING METHOD

1. Test the perimeter of the home at 6 locations.
2. Take the reading at the depth of the footer.
3. Using 500 lb. increments, take the lowest reading and round down to that increment.



X _____ X _____ X _____

TORQUE PROBE TEST

The results of the torque probe test is _____ inch pounds or check here if you are declaring 5' anchors without testing _____. A test showing 275 inch pounds or less will require 5' anchors.

Note: A state approved lateral arm system is being used and 4 ft. anchors are allowed at the sidewall locations. I understand 5' anchors are required at all centerline tie points where the torque test reading is 275 or less and where the mobile home manufacturer may require anchors with 4000 lb. holding capacity.

Installer's initials KJ

ALL TESTS MUST BE PERFORMED BY A LICENSED INSTALLER

Installer Name Kyhe Johnson

Date Tested Assumed OLIVER 11/11/15 uses 4x5' anchors

ELECTRICAL

Connect electrical conductors between multi-wide units, but not to the main power source. This includes the bonding wire between multi-wide units. Pg. _____

PLUMBING

Connect all sewer drains to an existing sewer tap or septic tank. Pg. _____

Connect all potable water supply piping to an existing water meter, water tap, or other independent water supply systems. Pg. _____

Permit Number: _____

Date: _____

Site Preparation

Debris and organic material removed
Water drainage: Natural _____ Swale _____ Pad Other _____

Fastening multi wide units

Floor- Type Fastener: Lag Length: 7" Spacing: 20
Walls- Type Fastener: Lag Length: 6" Spacing: 10
Roof- Type Fastener: Lag Length: 7" Spacing: 20

For used homes a min. 30 gauge, 8" wide, galvanized metal strip will be centered over the peak of the roof and fastened with galv. roofing nails at 2" on center on both sides of the centerline.

Gasket (weatherproofing requirement)

I understand a properly installed gasket is a requirement of all new and used homes and that condensation, mold, mildew and buckled marriage walls are a result of a poorly installed or no gasket being installed. I understand a strip of tape will not serve as a gasket.

Installer's initials KJ

Type gasket _____
Pg. Factory

Installed:
Between Floors-----Yes
Between Walls-----Yes
Bottom of ridge beam---Yes

Weatherproofing

The bottom board will be repaired and/or taped.-----Yes _____ Pg. _____
Siding on units is installed to manufacturer's specifications.-----Yes _____
Fireplace chimney installed so as not to allow intrusion of rain water.---Yes _____

Miscellaneous

Skirting to be installed. -----Yes No _____ N/A _____
Dryer vent installed outside of skirting.-----Yes No _____ N/A _____
Range downflow vent installed outside of skirting.---Yes No _____ N/A _____
Drain lines supported at 4' intervals.-----Yes No _____ N/A _____
Electrical crossovers protected.-----Yes No _____ N/A _____
Other: _____

Installer verifies all information given with this permit worksheet is accurate and true based on the manufacturer's installation instructions and or Rule 15C-1 & 2

Installer's Signature Kyhe Johnson

Date 5-11-26

SOIL BEARING LOAD = 2000LBS
 1500LBS=16"x16" FOOTERS
 2180LBS=16"x16" FOOTERS
 5766LBS=20"x20" FOOTERS

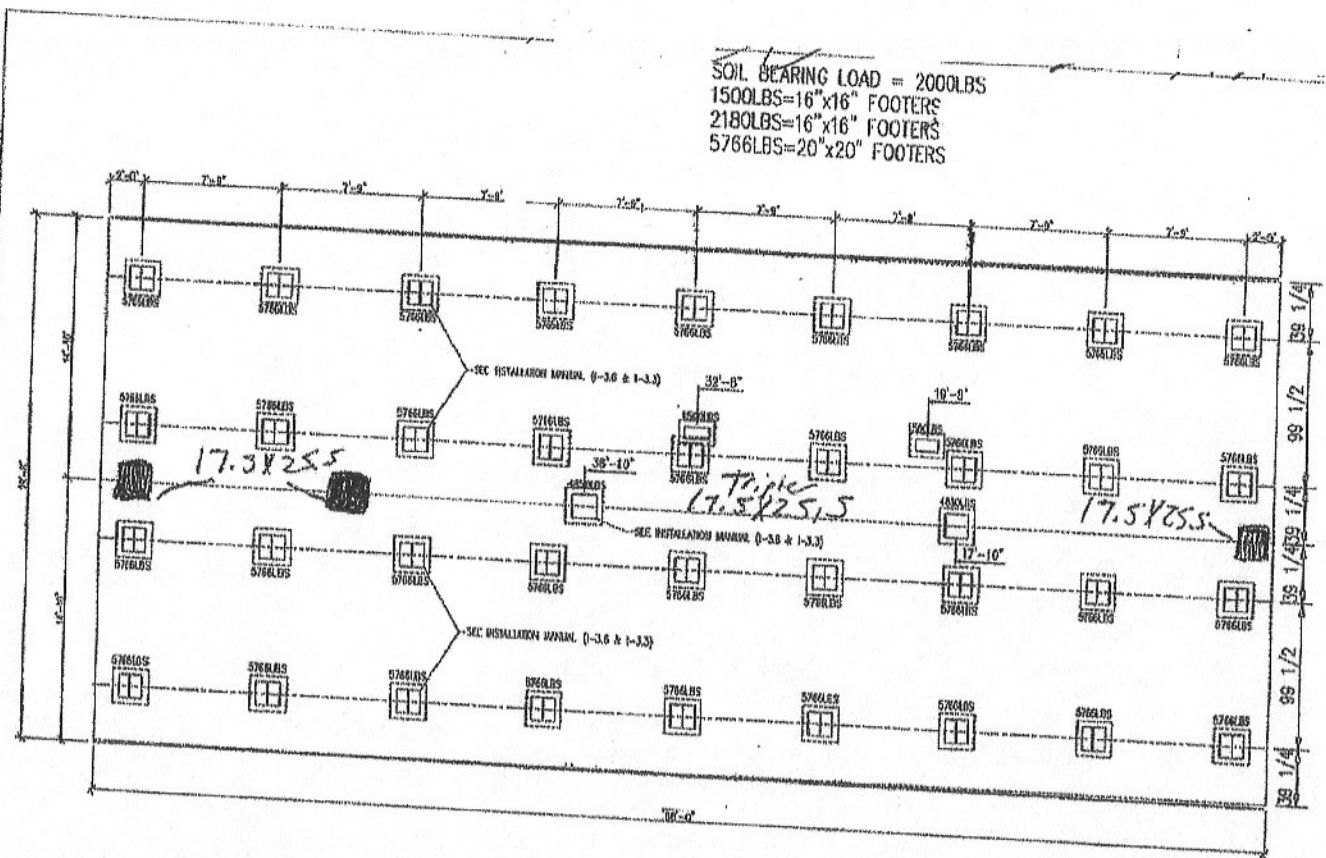

- NOTES:
- FOUNDATION & ANCHORING FOR ALL DESTINY MANUFACTURED HOMES MUST COMPLY WITH THE REQUIREMENTS OF THE DESTINY INSTALLATION MANUAL. THIS DRAWING IS NOT AN APPROVAL DRAWING AND DOES NOT REPRESENT THE MAXIMUM REQUIREMENTS; IT IS A TYPICAL REPRESENTATION OF A PERMANENT FOUNDATION.
 - ALL PIERS ARE 8"x16" (SINGLE STACK UP TO 36") AND 16"x16" (DOUBLE STACK UP TO 67") CMH'S ON 24"x24"x8" CONCRETE FOOTINGS (TOP) AND REQUIRED ON EACH SIDE OF EXTERIOR DOORS AND OTHER SIDEWALL OPENINGS GREATER THAN 4'-0". (BAY WINDOWS, PATIO DOORS, ATTIUM DOORS, MULTIPLE WINDOWS, PORCHES, RECESSED ENTRIES, FIREPLACES, ETC).
 - PIER CAPACITIES 32" WIDE - 5766#
 - SOIL BEARING CAPACITY = 2000#f MINIMUM
 - FOUNDATION TO MEET ALL APPLICABLE STATE AND LOCAL BUILDING CODES.
 - REMOVE SPRING HANGERS IF NECESSARY TO CLEAR PIERS.
 - DO NOT ALTER THE I-BEAMS, OUTRIGGERS OR CROSSMEMBERS.
 - FOR FHA APPROVAL, REFER TO THE GENERIC FHA DRAWING WHICH SHOW THE ENGINEERING REQUIREMENTS.

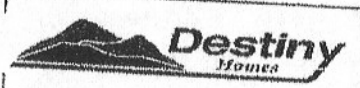
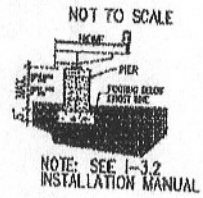

| REVISIONS |
|-----------|
| |
| |
| |
| |

| | | | | | | | |
|--------------------------|------------------------|----------|--------------|---------|------------------|------------|--------------|
| DRAWING TITLE | FOUNDATION PLAN | | | PRODUCT | TIMBERLINE ELITE | SERIAL NO. | |
| DRAWING FILE INFORMATION | 32X66 3BR--2BA | DRAWN BY | JERRY DENTON | DATE | 01/27/2023 | MODEL NO. | 290TE-32683E |
| | | | | SHEET | | SG. FT. | 1958 |

License Number: IH / 1126657 / 1 Name: KYLE JOHNSON

| | | | |
|----------------------|-----------------|----------------------------------|------------------------|
| Order #: 7027 | Label #: 129888 | Manufacturer: | (Check Size of Home) |
| Homeowner: | | Year Model: | Single _____ |
| Address: | | Length & Width: | Double _____ |
| City/State/Zip: | | Type Longitudinal System: | Triple _____ |
| Phone #: | | Type Lateral Arm System: | HUD Label #: |
| Date Installed: | | New Home: _____ Used Home: _____ | Soil Bearing / PSF: |
| Installed Wind Zone: | | Data Plate Wind Zone: | Torque Probe / in-lbs: |
| Note: | | | Permit #: |



**STATE OF FLORIDA
INSTALLATION CERTIFICATION LABEL**

129888

| | |
|------------------|----------------------|
| LABEL # | DATE OF INSTALLATION |
| KYLE JOHNSON | |
| NAME | |
| IH / 1126657 / 1 | 7027 |
| LICENSE # | ORDER # |

CERTIFIES THAT THE INSTALLATION OF THIS MOBILE HOME IS IN ACCORDANCE WITH FLORIDA STATUTES 320.8249, 320.8325 AND RULES OF THE HIGHWAY SAFETY AND MOTOR VEHICLES.

INSTRUCTIONS

PLEASE WRITE DATE OF INSTALLATION AND AFFIX LABEL NEXT TO HUD LABEL. USE PERMANENT INK PEN OR MARKER ONLY. COMPLETE INFORMATION ABOVE AND KEEP ON FILE FOR A MINIMUM OF 2 YEARS. YOU ARE REQUIRED TO PROVIDE COPIES WHEN REQUESTED.



OLIVER TECHNOLOGIES, INC.
FLORIDA INSTALLATION INSTRUCTIONS FOR THE
MODEL 1101 "V" SERIES ALL STEEL FOUNDATION SYSTEM

MODEL 1101 "V" (Steps 1-14)
LONGITUDINAL ONLY: Follow Steps 1-9
LATERAL ONLY: Follow Steps 1-3 and Steps 10-14
FOR CONCRETE APPLICATIONS: Follow Steps 15-18

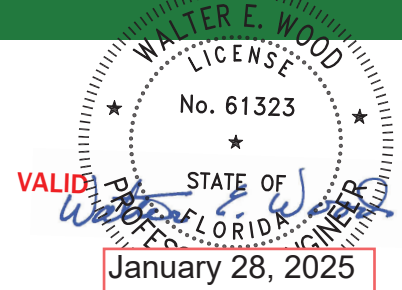

ENGINEERS STAMP

1. SPECIAL CIRCUMSTANCES: If the following conditions occur - **STOP! Contact Oliver Technologies at 1-800-284-7437 :**

- a) Pier height exceeds 48"
- b) length of home exceeds 76'
- c) Roof eaves exceed 16"
- d) Sidewall height exceed 96"
- e) Location is within 1500 feet of coast

INSTALLATION OF GROUND PAN

2. Remove weeds and debris in an approximate two foot square to expose firm soil for each ground pan (C) .
3. Place ground pan (C) directly below chassis I-beam. Press or drive pan firmly into soil until flush or below soil then install pier per manufacturer's instructions or per Florida Regs.

SPECIAL NOTE: The longitudinal "V" brace system may also serve as a pier under the home and should be loaded as any other pier. It is recommended that after leveling piers, and one-third inch (1/3") before home is lowered completely on to piers, complete steps 4 through 9 below then remove jacks.

INSTALLATION OF LONGITUDINAL "V" BRACE SYSTEM (Model 1101 L "V")

NOTE: WHEN INSTALLING THE LONGITUDINAL SYSTEM ONLY, A MINIMUM OF 2 SYSTEMS PER FLOOR SECTION IS REQUIRED. SOIL TEST PROBE SHOULD BE USED TO DETERMINE CORRECT TYPE OF ANCHOR PER SOIL CLASSIFICATION. IF PROBE TEST READINGS ARE BETWEEN 175 & 275 A 5 FOOT ANCHOR MUST BE USED. IF PROBE TEST READINGS ARE BETWEEN 276 & 350 A 4 FOOT ANCHOR MAY BE USED. USE GROUND ANCHORS WITH DIAGONAL TIES AND STABILIZER PLATES EVERY 5'4" . VERTICAL TIES ARE ALSO REQUIRED ON HOMES SUPPLIED WITH VERTICAL TIE CONNECTION POINTS (PER FLORIDA REG.).

4. Choose one of the approved longitudinal tube installations; either Diagram A or B. Then select the correct square tube (E) length from the diagram for appropriate pier height at support location or cut and drill 1.5" square tube to achieve appropriate length.

| PIER HEIGHT (40° Min. - 45° Max.) | 1.25" Tube Length | 1.50" Tube Length |
|--------------------------------------|----------------------|----------------------|
| 7 3/4" to 25" | 22" | 18" |
| 24 3/4" to 32 1/4" | 32" | 18" |
| 33" to 41" | 44" | 18" |
| 40" to 48" | 54" | 18" |

Diagram A

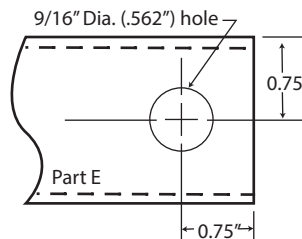

| PIER HEIGHT (40° Min. - 60° Max.) | 1.50" Tube Length |
|--------------------------------------|----------------------|
| 14" to 18" | 20" |
| 18" to 25" | 28" |
| 24" to 35" | 39" |
| 30" to 40" | 44" |
| 36" to 48" | 54" |

Diagram B

5. Install (2) of the 1.50" square tubes (E) into the "U" bracket (J), insert carriage bolt and leave nut loose for final adjustment.
6. Place I-beam connector (F) loosely on the bottom flange of the I-beam.
7. (For Diagram A installation) Slide the selected 1.25" tube (E) into a 1.50" tube (E) and attach to I-beam connectors (F) and fasten loosely with bolt and nut. (For Diagram B installation) Attach the selected 1.5" tubes (E) to the I-beam connectors (F) and fasten loosely with bolts and nuts.
8. Repeat steps 6 through 7 to create the "V" pattern of the square tubes loosely in place.
9. Using standard hand tools tighten all nuts and bolts. (For Diagram A installation only, secure 1.25" and 1.50" tubes using four(4) 1/4"-14 x 3/4" self-tapping screws in pre-drilled holes.)

INSTALLATION OF LATERAL TELESCOPING TRANSVERSE ARM SYSTEM (Model 1101 T "V")

THE MODEL 1101 "V" (LONGITUDINAL & LATERAL PROTECTION) ELIMINATES THE NEED FOR STABILIZER PLATES & FRAME TIES.

NOTE: THE USE OF THIS SYSTEM REQUIRES VERTICAL TIES SPACED AT 5'4".

FOUR FOOT (4') GROUND ANCHOR MAY BE USED EXCEPT WHERE THE HOME MANUFACTURER SPECIFIES DIFFERENT.

10. Install remaining vertical tie-down straps and 4' ground anchors per home manufacturer's instructions. NOTE: Centerline anchors to be sized according to soil torque condition. Any manufacturer's specifications for sidewall anchor loads in excess of 4,000 lbs. require a 5' anchor per Florida Code.
11. Select the correct square tube brace (H) length for set-up lateral transverse at support location. The lengths come in either 60" or 72" lengths. (With the 1.50" tube as the bottom tube, and the 1.25" tube as the inserted tube.)
12. Install the 1.50 transverse brace (H) to the ground pan connector (D) with bolt and nut.
13. Slide 1.25" transverse brace into the 1.50" brace and attach to adjacent I-beam connector (I) with bolt and nut.
14. Secure 1.50" transverse arm to 1.25" transverse arm using four (4) 1/4" - 14 x 3/4" self-tapping screws in pre-drilled holes.

INSTALLATION USING CONCRETE RUNNER/ FOOTER

15. A concrete runner, footer or slab may be used in place of the steel ground pan.
 - a) The concrete shall be minimum 2500 psi mix
 - b) A concrete runner may be either longitudinal or transverse, and must be a minimum of 8" deep with a minimum width of 16 inches longitudinally or 18 inches transverse to allow proper distance between the concrete bolt and the edge of the concrete (see below).
 - c) Footers must have minimum surface area of 441 sq. in. (I.e. 21" square), and must be a minimum of 8" deep.
 - d) If a full slab is used, the depth must be a 4" minimum . Special inspection of the system bracket installation is not required. Footers must allow for at least 4" from the concrete bolt to the edge of the concrete.

NOTE: The bottom of all footings, pads, slabs and runners must be per local jurisdiction.



LONGITUDINAL: (Model 1101 LC "V")

16. When using Part# 1101-W-CPCA (wetset) simply install the bracket in runner/footer **OR** When installing in cured concrete use Part# 101-D-CPCA (dryset). The 1101 (dryset) CA bracket is attached to the concrete using (2) 5/8"x3" concrete wedge bolts (Simpson part # S162300H 5/8" X 3" or Powers equivalent). Place the CA bracket in desired location. Mark bolt hole locations, then using a 5/8" diameter masonry bit, drill a hole to a minimum depth of 3". Make sure all dust and concrete is blown out of the holes. Place wedge bolts into drilled holes, then place 1101 (dry set) CA bracket onto wedge bolts and start wedge bolt nuts. Take a hammer and lightly drive the wedge bolts down by hitting the nut (making sure not to hit the top of threads on bolt). The sleeve of concrete wedge bolt needs to be at or below the top of concrete. Complete by tightening nuts.

LATERAL: (Model 1101 TC "V")

17. For wet set (part # 1101-W-TACA) installation simply install the anchor bolt into runner/footer. For dry set installation (part # 1101-D-TACA) mark bolt hole locations, then using a 5/8" diam. masonry bit. drill a hole to a minimum depth of 3". Make sure all dust and concrete is blown out of the hole. Place wedge bolts (Simpson part #S162300H 5/8" X 3" or Powers equivalent) into (D) concrete dry transverse connector and into drilled hole. If needed, take a hammer and lightly drive the wedge bolts down by hitting the nut (making sure not to hit the top of threads on bolt), then remove the nut. The sleeve of concrete wedge bolt needs to be at or below the top of concrete.
18. When using part# 1101 CVW (wetset) or 1101 CVD (dryset), install per steps 17 & 18.

Notes:

1. LENGTH OF HOUSE IS THE ACTUAL BOX SIZE
2.  = LOCATION OF TRANSVERSE BRACING ONLY
3.  = LOCATION OF LONGITUDINAL BRACING ONLY
4.  = TRANSVERSE AND LONGITUDINAL LOCATIONS

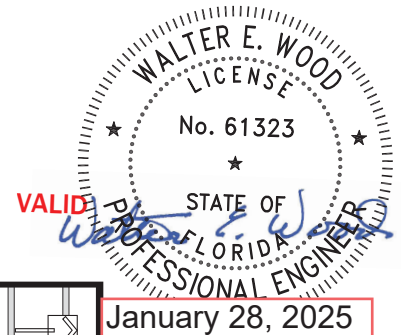

ALL WIDTHS AND LENGTHS UP TO 52'

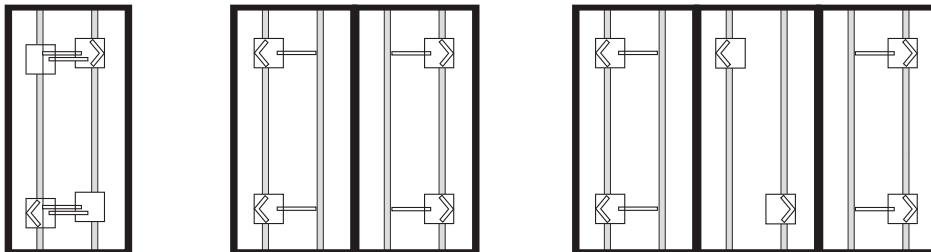

ALL WIDTHS AND LENGTHS OVER 52' TO 80"

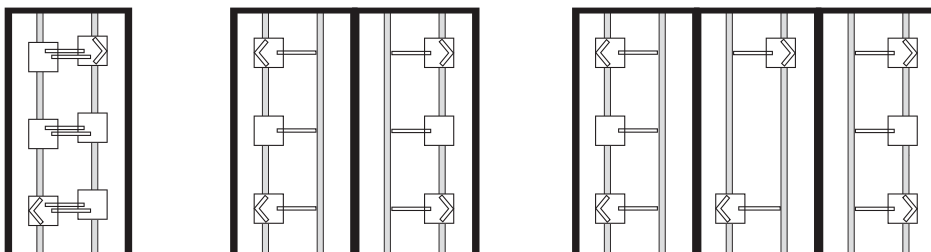

HOMES WITH 5/12 ROOF PITCH REQUIRE: PER FLORIDA REGULATIONS
6 systems for home lengths up to 52' and 8 systems for homes over 52' and up 80'.

PATENT# 6634150 & OTHER PATENT PENDING

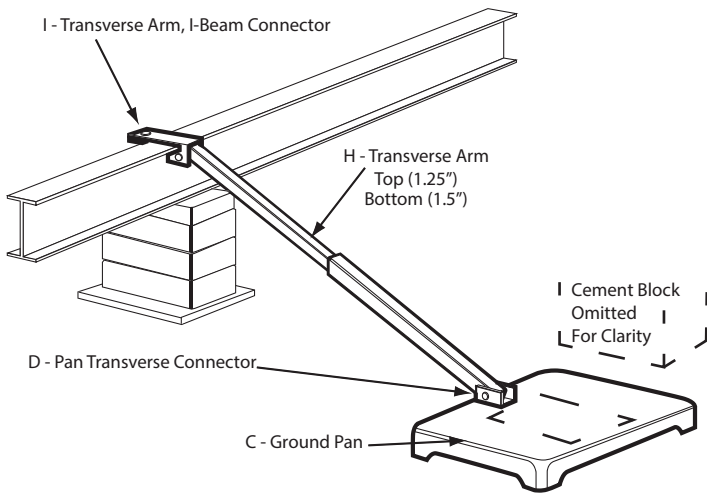

Model # 1101 T "V"

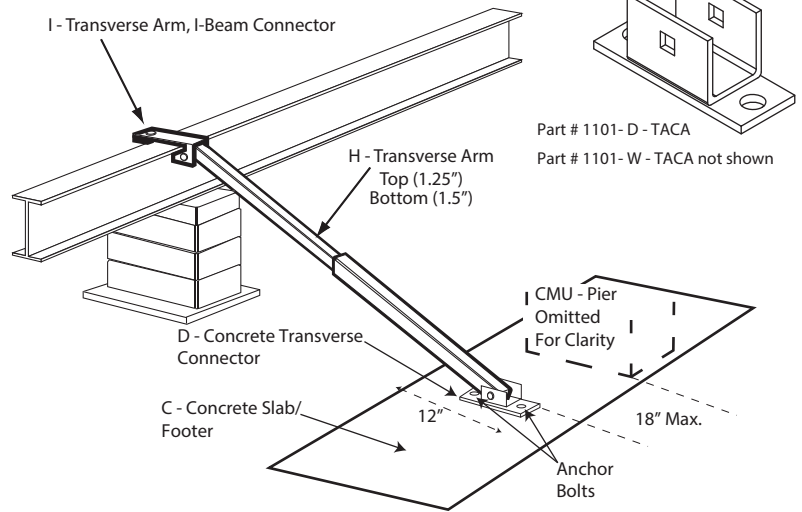

Model # 1101 TC "V"

Florida approved 4' ground anchors may be used in all locations except where home manufacturers specifications for sidewall straps are in excess of 4,000 lbs. These locations require a 5' anchor. Per Florida code.

C = GROUND PAN / CONCRETE FOOTER OR RUNNER

D = GROUND PAN / CONCRETE U BRACKETS TRANSVERSE CONNECTOR (connects with grade 5 - 1/2" x 2" 1/2" carriage bolt and nut)

E = TELESCOPING V BRACE TUBE ASSEMBLY (1.5" TUBE BOTTOM AND 1.25" TUBE INSERT) OR 1.5" TUBE

F = "V" BRACE I-BEAM CONNECTOR ASSEMBLY

H = TELESCOPING TRANSVERSE ARM ASSEMBLY

I = TRANSVERSE ARM I-BEAM CONNECTOR (connects with grade 5 - 1/2" x 2" 1/2" carriage bolt and nut)

J = V PAN BRACKET (connects with grade 5 - 1/2" x 2" 1/2" carriage bolt and nut)

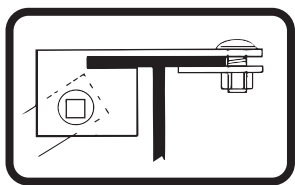

I - Transverse Arm, I-Beam Connector

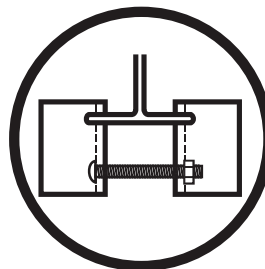

F - "V" Brace I-Beam Connectors

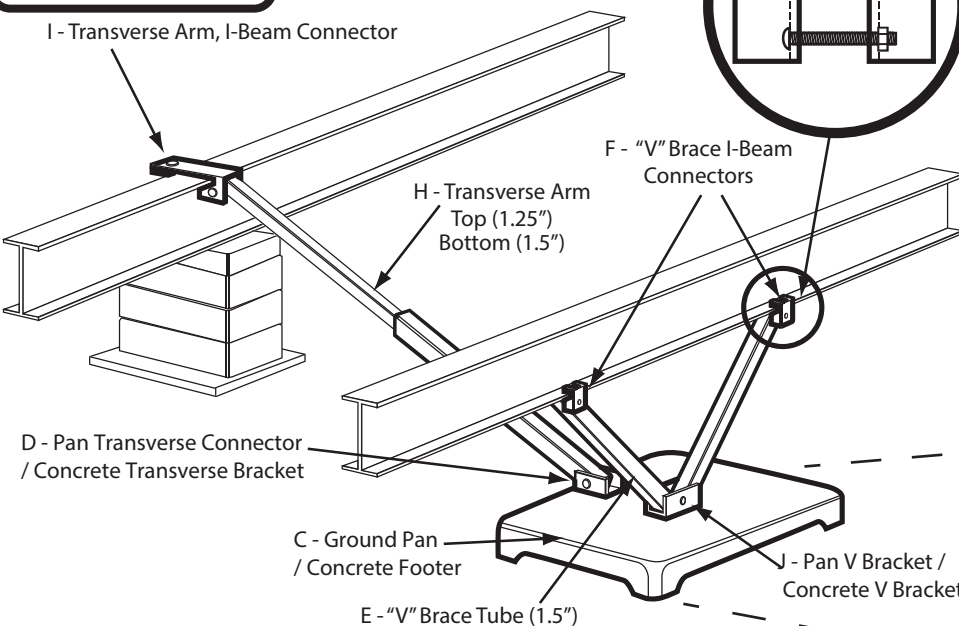

Model # 1101 "V"

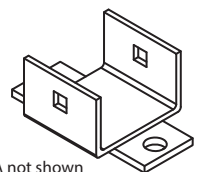

Part# 1101 D-CPCA
Part # 1101 W-CPCA not shown

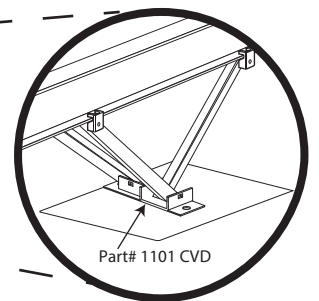

Model # 1101 C "V"

**For use on all Mobile and Manufactured Homes, including
HUD approved Homes and Modular Building
Patent #5503500 and other patents pending**

GENERAL INSTRUCTIONS:

1. All pads are to be installed flat side down, ribbed side up.
2. The ground under the pads should be leveled as smooth as possible with all vegetation and debris removed. Pads to be placed on evenly compacted soil, at or below the frost line unless otherwise protected from frost by controlling the temperature and/ or moisture content of the soil underneath the home.
3. Pier & pad placement will be determined by the manufactured homes' written set-up instructions or any local or state codes.
4. Center blocks on ABS pad and complete pier.
5. The open cells between the ribbing on the upper side of the pads may be filled with soil or sand after installation to prevent any accumulation of stagnant water in the pads.
6. A pocket penetrometer may be used to determine the unconfined compressive strength of the soil. If no soil testing equipment is available – use an assumed soil value of 1000 lbs. / square foot.

NOTES:

1. All pad sizes shown are nominal dimensions and may vary up to 1/8".
2. The maximum deflection in a single pad is 5/8" measured from the highest point to the lowest point of the top face.
(NOTE: Actual test results were less than 5/8")
3. Pad loads are the same when using single stack or double stack blocks.
4. The maximum load at any intermediate soil value may be interpolated between the next lower and next higher soil values given in the table below.
5. Any ABS pad configuration may be used to replace a home manufacturer's recommended concrete or wood base pad.
6. Steel Piers: All pads are tested with steel piers on 1000 PSF soil density unless otherwise noted. If required, attach with 2" #12 x 1/2" hex tech screws. Minimum Pier Base 7 1/4". Multi-Pad configurations require a minimum 9 1/4" pier base.
7. Available pads tested on 2000 PSF soil capacity using steel piers are: ID #1055-14, 1055-9, 1055-7 and 1055-13.
8. If soil capacities exceed 3000 psf, use the 3000 psf soil values from the table.
9. Any pad may be stacked directly on top of an identical pad. The second pad should also be installed flat side down. Such a configuration provides the same allowable load capacity as the single pad.

| PAD SIZE | ID NO. | PAD AREA | 1000 PSF | 1500 PSF | 2000 PSF | 2500 PSF | 3000 PSF |
|----------------------|---------|-------------|-----------|-----------|-------------|--------------|--------------|
| Oval 16" x 18.5" | 1055-23 | 288 sq. in. | 2000 lbs. | 3000 lbs. | 4000 lbs. | 5000 lbs. | 6000 lbs. |
| Oval 17" x 22" | 1055-16 | 360 sq. in. | 2500 lbs. | 3750 lbs. | 5000 lbs. | 6250 lbs. | 7500 lbs. |
| Oval 17.5" x 22.5" | 1055-21 | 384 sq. in. | 2667 lbs. | 4000 lbs. | 5334 lbs. | 6667 lbs. | 8000 lbs. * |
| Oval 17.5" x 25.5" | 1055-17 | 432 sq. in. | 3000 lbs. | 4500 lbs. | 6000 lbs. | 7500 lbs. | 9000 lbs. * |
| Oval 21" x 29" | 1055-22 | 576 sq. in. | 4000 lbs. | 6000 lbs. | 8000 lbs. * | 10000 lbs. * | 12000 lbs. * |
| Oval 23.25" x 31.25" | 1055-20 | 675 sq. in. | 4688 lbs. | 7032 lbs. | 9376 lbs. * | 11720 lbs. * | 14064 lbs. * |

| PAD SIZE | ID NO. | PAD AREA | 1000 PSF | 1500 PSF | 2000 PSF | 2500 PSF | 3000 PSF |
|----------------------|---------|-------------|-----------|-----------|-------------|--------------|--------------|
| Square 16" x 16" | 1055-14 | 256 sq. in. | 1778 lbs. | 2664 lbs. | 3556 lbs. | 4445 lbs. | 5333 lbs. |
| Square 18.5" x 18.5" | 1055-9 | 342 sq. in. | 2375 lbs. | 3550 lbs. | 4750 lbs. | 5935 lbs. | 7100 lbs. |
| Square 20" x 20" | 1055-7 | 400 sq. in. | 2750 lbs. | 4125 lbs. | 5500 lbs. | 6875 lbs. | 8250 lbs. * |
| Square 24" x 24" | 1055-13 | 576 sq. in. | 4000 lbs. | 6000 lbs. | 8000 lbs. * | 8000 lbs. * | 8000 lbs. * |
| Square 24" x 24" | 1055-26 | 576 sq. in. | 4000 lbs. | 6000 lbs. | 8000 lbs. * | 10000 lbs. * | 12000 lbs. * |

* Indicates that Piers are required to be double blocked.

EXAMPLE: 16' x 80' section (Alabama only)

| PAD SIZE | 1000 PSF | 2000 PSF |
|--------------------|----------|----------|
| Oval 16" x 18.5" | 3'0" | 6'0" |
| Oval 17" x 22" | 3'9" | 7'6" |
| Oval 17.5" x 22.5" | 4'0" | 8'0" |
| Oval 17.5" x 25.5" | 4'5" | 8'0" |
| Oval 21" x 29" | 6'0" | 8'0" |



Jul 14, 2020

Multi-Pad Configurations

| ABS Pad Types | | | 8" Cell Block | Soil Bearing Value | Maximum Load | |
|---|------------------|--------------|-------------------------------|--------------------|---------------------|--------------|
| Oval 16" x 18.5" Pad | 2.00 Square Feet | ID # 1055-23 | 32" x 18.5" Pad Configuration | Single Stack | 1000 lbs. / sq. ft. | 4000 lbs. |
| Oval 32" x 18.5" Pad Configuration (03) | 4.00 Square Feet | | | Double Stack | 2000 lbs. / sq. ft. | 8000 lbs. * |
| Oval 17" x 22" Pad | 2.50 Square Feet | ID # 1055-16 | 34" x 22" Pad Configuration | Single Stack | 1000 lbs. / sq. ft. | 5000 lbs. |
| Oval 34" x 22" Pad Configuration (03) | 5.00 Square Feet | | | Double Stack | 2000 lbs. / sq. ft. | 10000 lbs. * |
| Oval 17.5" x 25.5" Pad | 3.00 Square Feet | ID # 1055-17 | 35" x 25.5" Pad Configuration | Single Stack | 1000 lbs. / sq. ft. | 6000 lbs. |
| Oval 35" x 25.5" Pad Configuration (03) | 6.00 Square Feet | | | Double Stack | 2000 lbs. / sq. ft. | 12000 lbs. * |

*Concrete blocks are only rated at 8000 pounds, 8001 pounds and higher must be double stacked.

PAD ASSEMBLY

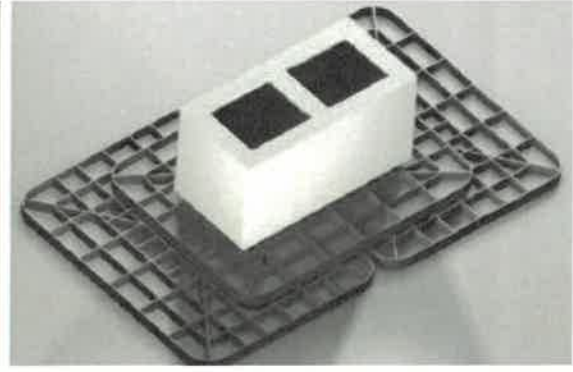
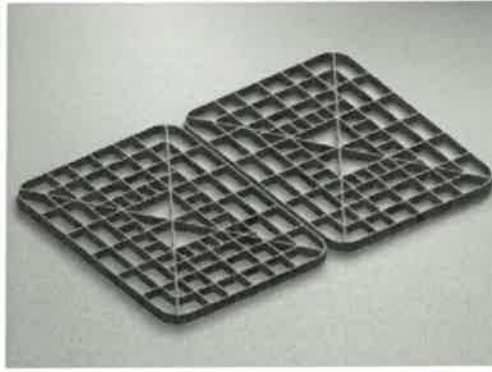
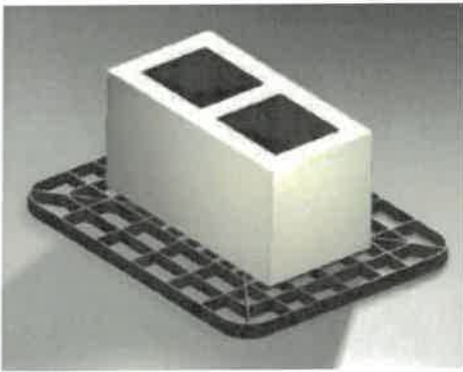

STEP 1 - 17" x 22" ABS Pad **STEP 2 - (2) 17" x 22" ABS PADS (34" x 22" Configuration)**

STEP 3 - Complete Assembly 34" x 22" Multi-pad Configuration

NOTES:

- General instructions (on reverse) apply to all multi – pad configurations.
- The 32" x 18.5" pad configuration is formed by using (3) 16" x 18.5" ABS Pads. Place (2) 16" x 18.5" side by side, and place (1) 16" x 18.5" on top, laid in the opposite direction to the bottom pads.
- The 34" x 22" pad configuration is formed by using (3) 17" x 22" ABS Pads. Place (2) 17" x 22" pads side by side, and (1) 17" x 22" pad on top. The top pad is laid in the opposite direction as the bottom pads.
- The 35" x 25.5" pad configuration is formed by using (3) 17.5" x 25.5" ABS Pads. Place (2) 17.5" x 25.5" pads side by side, and (1) 17.5" x 25.5" pad on top. The top pad is laid in the opposite direction to the bottom pads.

STATE SPECIFIC NOTES:

TEXAS: 17.5" x 22.5" ID #1055-21 and 23.25" x 31.25" ID #1055-20 may not be installed in the State of Texas. ID#1055-26 may not be used in conjunction with metal piers.

CALIFORNIA: Use an assumed value of 1000 lb/sq. ft. unless engineering and calculations are provided.

ALABAMA : For the State of Alabama all ABS pads shall not have more than 3/8" deflection. See chart on page one for details on correct installation in Alabama. The 23.25" x 31.25" ID#1055-20 may not be installed in the State of Alabama.

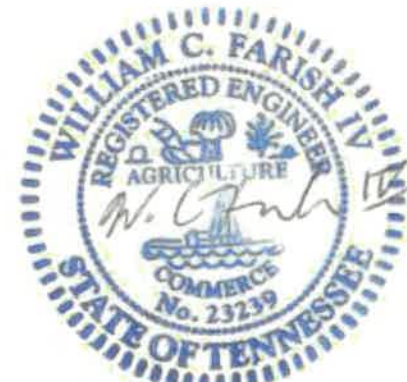

Jul 14, 2020

Table 1: ABS Pier Pad Single & Double CMU Pier Models and Maximum Load Capacities.

| Model | Dimension (in. x in.) | Maximum Pier Load (lbf) | | | |
|--|-----------------------|--|---------|---------|---------|
| | | Soil Unconfined Compression Strength (psf) | | | |
| | | 1,000 | 2,000 | 2,500 | 3,000 |
| 1055-14** | 16 x 16 | 1,780** | 3,560** | 4,450 | 5,340 |
| 1055-23 | 16 x 18 | 2,000 | 4,000 | 5,000 | 6,000 |
| 1055-9** | 18.5 x 18.5 | 2,375** | 4,750** | 5,935 | 7,100 |
| 1055-16 | 17 x 22 | 2,500 | 5,000 | 6,250 | 7,500 |
| 1055-21 | 17.5 x 22.5 | 2,667 | 5,334 | 6,668 | 8,000 |
| 1055-7** | 20 x 20 | 2,750** | 5,500** | 6,875 | 8,250* |
| 1055-17 | 17.5 x 25.5 | 3,000 | 6,000 | 7,500 | 9,000* |
| 1055-13** | 24 x 24 | 4,000** | 8,000** | | |
| 1055-26 | 24 x 24 | 4,000 | 8,000 | 10,000* | 12,000* |
| 1055-22 | 21 x 29 | 4,000 | 8,000 | 10,000* | 12,000* |
| 1055-20 | 23.25 x 31.25 | 4,698 | 9,396* | 11,745* | 14,094* |
| All pads can be utilized with a single CMU, except where * indicates double-CMUs are required. | | | | | |
| ** Indicates when and at what capacities steel piers can be used. | | | | | |

Table 2: ABS Shims and Pier Caps Design Load Capacity

| Installation | Maximum Component Load (lbf) |
|--|------------------------------|
| One or Two Stacked ABS Capboards | 8,000 |
| Two Stacked ABS Pier Capboards Stacked Parallel | 16,000 |
| ABS Shims (single CMU Pier, used in pairs) | 8,000 |
| ABS Shims used with ABS Cap on two stacked Parallel on Double CMU Pier | 16,000 |

Table 3: Multi-Pad Configurations

| Dimension (in. x in.) | Area (ft ²) | Model | Multi-Pad Configuration | 8" Cell Block | Soil Bearing Value | Maximum Load |
|-----------------------|-------------------------|---------|------------------------------------|---------------|----------------------------|--------------|
| 16 x 18 | 2 | 1055-23 | 32" x 18" 3 Pad Configuration | Single Stack | 1,000 lbs./ft ² | 4,000 lbs. |
| 32 x 18 (3 pad) | 4 | | | Double Stack | 2,000 lbs./ft ² | 8,000 lbs.* |
| 17 x 22 | 2.5 | 1055-16 | 34" x 22" 3 Pad Configuration | Single Stack | 1,000 lbs./ft ² | 5,000 lbs. |
| 34 x 22 (3 pad) | 5 | | | Double Stack | 2,000 lbs./ft ² | 10,000 lbs.* |
| 17.5 x 25.5 | 3 | 1055-17 | 35" x 25.5" 3 Pad Configuration | Single Stack | 1,000 lbs./ft ² | 6,000 lbs. |
| 35 x 25.5 (3 pad) | 6 | | | Double Stack | 2,000 lbs./ft ² | 12,000 lbs.* |

***Concrete blocks are only rated at 8,000 pounds, 8,001 pounds and higher must be double stacked.**

Three Pad Configuration

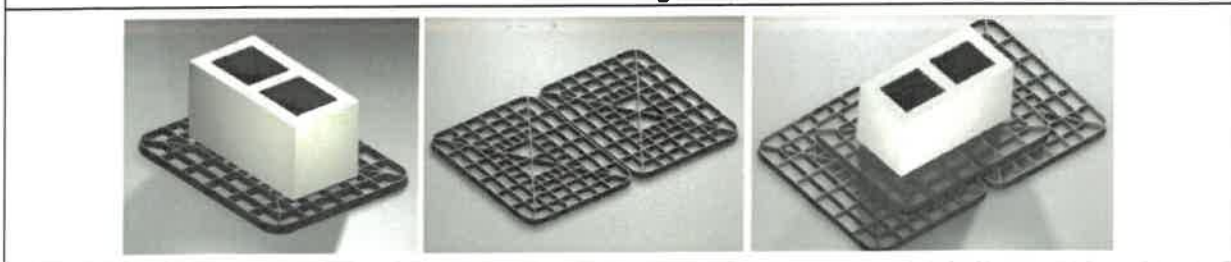

OLIVER TECHNOLOGIES, INC.
Installation Instructions for 1100 Series All Steel Foundation System
Wind Zones I & II

SPECIAL CIRCUMSTANCES: If the following conditions occur – STOP! Contact Oliver Technologies at 1-800-284-7437

- › Any frame pier height exceeds 48" › Roof eaves exceed 16" › Location is within 1,500' of coastline
- › Soil conditions less than 4B › Roof pitch greater than 7/12 › Sidewall height exceeds 9' (108")

The 1100 series ASFS Offers 3 packages:

1. 1100ITV (1 Arm/Brace– Lateral) see 1,3, 9-12
2. 1100IV (3 Arm/Brace– Lateral and Longitudinal- Replaces Pier) 1,3, 4a-8a, 9-12
3. 1100 SOLO (2 Arm/Brace– Lateral and Longitudinal) 1-3, 4b-8b, 9-12



INSTALLATION OF GROUND PAN FOR DIRT SET

1. Remove weeds and debris in an approximate 3' square to expose firm, level undisturbed soil or controlled fill for each ground pan. The 1100 Pan is equivalent to a 21" x 21" footing. Top of ground pan (C) must be installed at ground level or per local jurisdiction. Ground pan can be installed below grade and backfilled as long as a distance between top of ground pan and bottom of frame does not exceed 48".
2. If using the SOLO longitudinal brace, ensure the longitudinal hardware is installed on the correct side. Hold lock washer flush to pan, hand tighten bolt and washer to lock washer. Hammer bolt head until washer and bolt are flush with pan. Refer to Diagram 1A.
3. Place center ground pan (C) directly below chassis I-Beam. Press or drive pan completely into soil until flush with or below soil.

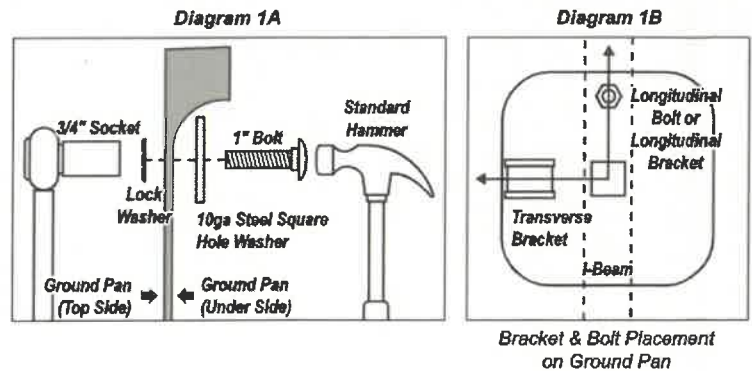

INSTALLATION OF LONGITUDINAL "V" BRACE SYSTEM

NOTE: For homes with reinforced I-beams, the 1100-10A-P longitudinal I-beam connector will replace the standard I-beam connector.

NOTE: For homes with double I-beams, the extended longitudinal I-beam connector hardware will replace the standard I-beam hardware. Please refer to addendum B for proper installation.

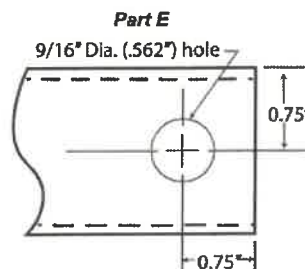

| PIER HEIGHT (40° MIN. - 60° MAX.) | 1.50" TUBE LENGTH |
|--------------------------------------|-------------------|
| 14" - 18" | 20" |
| 18" - 25" | 28" |
| 24" - 35" | 39" |
| 30" - 40" | 44" |
| 36" - 48" | 54" |

PIER HEIGHT = The dimension from the top of the pan to the bottom of the I-Beam

*Vertical pier load should not exceed 4,800lbs

- 4a. Select the correct square tube brace (E) length for set-up (pier) height at support location.
 - 5a. Install end of the 1.50" square tubes (E) into the "V" bracket (J), insert carriage bolt and leave nut loose for final adjustment.
 - 6a. Place both longitudinal I-Beam connector (F) loosely on the bottom flange of the I-Beam.
 - 7a. Attach the selected 1.5" tubes (E) to the I-Beam connectors (F) and fasten loosely with bolts and nuts.
- NOTE:** The ground pan must be level in both directions to ensure the angle markings on the center point connector are correct from the horizontal plane of the pan. The angle is not to exceed 60° and not less than 40°. The "V" bracket is stamped with angle marks to use as a guide. Use an Angle Finder to verify proper angle. Use proper length tube or cut and drill tube to achieve proper length. (The tube may be cut using any appropriate steel cutting method such as reciprocating saw, band saw etc. New holes must be drilled to the dimension and at the location as shown for part (E).

- 8a. The V-brace system functions as a structural pier beneath the home and must be loaded in the same manner as all other piers. After leveling, stop approximately 1/2" before the home is fully lowered onto the piers. Tighten all hardware securely using standard hand tools, ensuring all nuts and bolts are tightened at least 1½ to 2 full turns past hand tight. Once all hardware is secure, lower the home completely onto the piers to ensure full load transfer.

INSTALLATION OF 1100 SOLO LONGITUDINAL BRACE

- 4b. Determine the correct length of the longitudinal brace (K) to be installed based on pier height.
- 5b. Make sure the longitudinal bolt (L) is centered under the I-Beam.
NOTE: It is required that each longitudinal brace is installed in opposite directions underneath the home.
- 6b. Place the flattened end of the longitudinal brace over the bolt (L) on the ground pan and loosely secure with provided nut and washer.
- 7b. Place both longitudinal I-Beam connectors (F) loosely on the bottom flange of the I-Beam.
- 8b. Attach the opposite end of the longitudinal brace to the bottom flange of the I-Beam using the longitudinal I-Beam connectors (F) with bolt and nut. Using standard hand tools, tighten all nuts and bolts.
NOTE: Angle of longitudinal brace must be between 15° and 45° from horizontal plane.

| PIER HEIGHT (15° MIN. - 45° MAX.) | LONGITUDINAL BRACE LENGTH |
|--------------------------------------|------------------------------|
| 12" - 24" | 39" |
| 12" - 32" | 44" |
| 12" - 40" | 54" |
| 12" - 48" | 65" |

PIER HEIGHT = The dimension from the top of the pan to the bottom of the I-Beam

INSTALLATION OF (LATERAL) TELESCOPING TRANSVERSE BRACE SYSTEM (1100 ITV)

- NOTE:** For homes with double I-beams, the extended lateral I-beam connector kit will replace the standard I-beam connector in Wind Zone I. Please refer to *addendum A* for proper installation.
9. Select the correct transverse brace (H). The 60" sections are standard. The 72" sections are used on frame widths greater than 99.5".
10. Install the 1.5" transverse brace (H) to the ground pan connector (D) with the 2.5" bolt and nut.
11. Slide 1.25" transverse brace into the 1.5" brace and attach to adjacent lateral I-beam connector (I) with 2.5" bolt and nut. Next, install the I-beam connector over the top flange of the I-beam and secure with Flat Clamp (P) using included 1.5" bolt and nut.
12. Secure 1.5" transverse brace using four (4) 1/4"-14 x 3/4" self-tapping screws in pre-drilled pilot holes. Drill speed should not exceed 1,800 RPM.

INSTALLATION USING CONCRETE (ICV)

The concrete footer, runner or slab that has a minimum of 2900 cu. in., with a minimum depth of 6" at each system location. The surface of the footing shall be large enough to support the pier load and allow at least 4" from the concrete bolt to the edge of the concrete (ie. 22" x 22" x 6" footer). The concrete shall be a minimum of 2500 psi mix (pre-blended sacked concrete mix is acceptable). Special inspection of footing is not required. If the 1100ITC Transverse system is to be installed without the use of a longitudinal system, it **MUST** be installed on same footing within 18" of pier. Provide a minimum spacing of 4" center-to-center between wedge bolt installations, and maintain a minimum distance of 4" from any concrete edge to the centerline of the wedge bolt.

LONGITUDINAL (V)

When using the 1100 wet set bracket, simply install the bracket in runner/footer OR when installing in cured concrete, use the 1100 dry set bracket. The 1100 dry set bracket is attached to the concrete using (2) 1/2" X 3" concrete wedge bolts. Center bracket under I-Beam in desired location. Mark bolt hole locations, then using a 1/2" masonry bit, drill a hole to a minimum depth of 3". Be sure all dust is blown out of the holes. Place wedge bolts into drilled holes, then place 1100 bracket onto wedge bolts and start wedge bolt nuts. Take a hammer and lightly drive the wedge bolts down by hitting the nut (Do not hit the top of threads on bolt). Complete by tightening the nuts.

LONGITUDINAL (SOLO)– Dry Concrete Only

Position longitudinal concrete bolt for installation and drill ½" hole. 3" deep into concrete. Make sure that the Longitudinal bolt is centered under the I-Beam. Be sure all dust is blown out of the holes. Place wedge bolt into drilled hole. Make sure starter nut is threaded onto wedge bolt. Then, lightly hammer wedge bolt into concrete. Leave approximately 1" of wedge bolt threads above surface. Remove starter nut from wedge bolt and follow applicable instructions based on system being installed.

LATERAL (Transverse Brace)

For wet set installation set the transverse connector bracket into runner/footer at desired location. For dry set installations, the transverse connector bracket is attached to the concrete using (2) 1/2" X 3" concrete wedge bolts. Mark bolt hole locations, then using a 1/2" masonry bit, drill a hole to a minimum depth of 3". Be sure all dust is blown out of the holes. Place wedge bolts into drilled holes, then place transverse connector bracket onto wedge bolts and start wedge bolt nuts. Take a hammer and lightly drive the wedge bolts down by hitting the nut (do not hit the top of threads on bolt.) Complete by tightening the nuts.

**REQUIRED NUMBER AND LOCATION OF MODEL
1100 SERIES BRACES FOR 4/12 & 5/12**

**REQUIRED NUMBER AND LOCATION OF MODEL
1100 SERIES BRACES FOR 6/12 & 7/12**

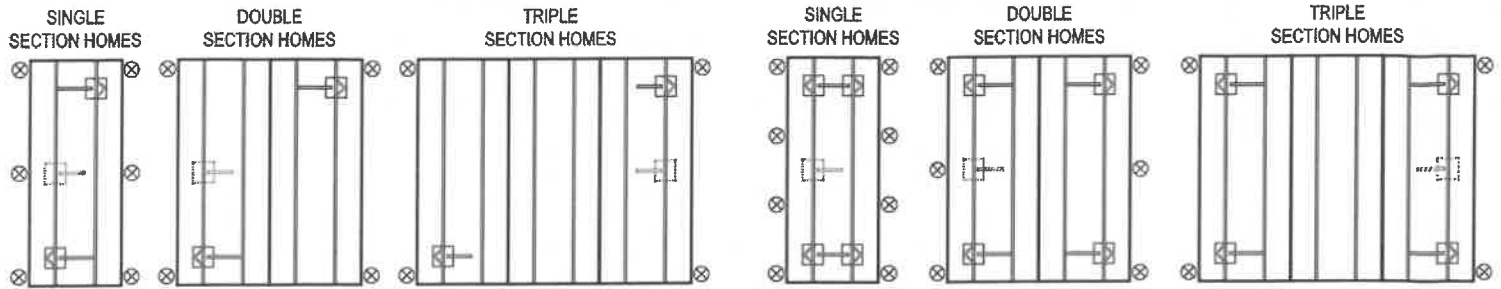

LEGEND

1. Location of ASF Model 1100 (Lateral and Longitudinal Bracing) or 1100 T (Lateral only) up to 76'.
2. For homes longer than 76' or with roof pitches ranging from 4.37/12 (20°) to 5/12, an additional ASF Model 1100 T System (Lateral only) must be positioned at roughly the midpoint of the house. This additional system can be mounted on either exterior beam. See illustration above.
3. Installation on all homes require a minimum number of uplift anchors in WZ I for enhanced wind protection. Strap angle 75-90°. Check anchor tables for details.

Wind Zone I Vertical Anchor Table

| Home Section | Home Width | 4:12 Roof Pitch | | 5:12 Roof Pitch | | 6:12/7:12 Roof Pitch | | |
|--------------|--------------------|-----------------------------|------------------|-----------------------------|------------------|-----------------------------|------------------|---|
| | | Home Length (Act. Box Size) | Anchors Per Side | Home Length (Act. Box Size) | Anchors Per Side | Home Length (Act. Box Size) | Anchors Per Side | |
| Single | 12' (Nominal) | up to 63' | 3 | up to 55' | 4 | up to 45' | 4 | |
| | 140" | 64'-90' | 4 | 56'-74' | 5 | 46'-62' | 5 | |
| | | | | | 75'-90' | 6 | 63'-78' | 6 |
| | | | | | | | 79'-90' | 7 |
| | 14'-18' (Nominal) | up to 73' | 3 | up to 58' | 4 | up to 47' | 4 | |
| 156" to 210" | 74'-90' | 4 | 59'-78' | 5 | 48'-64' | 5 | | |
| | | | | 79'-90' | 6 | 65'-81' | 6 | |
| | | | | | | 82'-90' | 7 | |
| Double | 20' (Nominal) | up to 90' | 2 | up to 90' | 3 | up to 90' | 4 | |
| | (2)118" | | | | | | | |
| | 24'-32' (Nominal) | up to 90' | 2 | up to 90' | 2 | up to 85' | 3 | |
| Triple | (2)140" to (2)186" | | | | | 86'-90' | 4 | |
| | 36'-48' (Nominal) | up to 90' | 2 | up to 90' | 2 | up to 90' | 2 | |
| | (3)140" to (3)186" | | | | | | | |

IMPORTANT: System Uplift Anchors are to be installed to the bottom of the rim joist with a 3150 lb. rated bracket and lag bolts, not to the I-Beam. Corner anchors should be installed within 2' of the end of the home and any additional anchors installed as evenly as possible per side.

NOTE: Alternative strapping methods are also approved to protect against uplift, including moving sidewall brackets and vertical straps inward up to 10" and locating the sidewall bracket on a floor joist. In addition to the required number of anchors listed on the Wind Zone I Vertical Anchor Table, one additional anchor per side is required on single section homes with roof pitches of 5/12 and 6/12. Two additional anchors per side are required on single section homes with a roof pitch of 7/12 or greater. Single section homes with a roof pitch lower than 5/12 and Multi Section homes require no additional anchors when relocating sidewall brackets.



INSTALLATION OF THE OT SWB SIDEWALL BRACKET

1. Locate the desired location under home, on underside of the rim or floor joist.
2. Position sidewall bracket with two holes centered on joist. Orientation of sidewall bracket does not affect performance.
3. Mark the center of both holes and pre-drill two pilot holes using a 15/64" drill bit.
4. Install (2) two lag bolts into pre-drilled holes to secure sidewall bracket.
Minimum size: 3/8"-7 x 3 1/2" with a minimum of 3 1/4" threads.
5. Refer to anchor and strapping installation instructions for proper installation of anchor and strap.

NOTE: The OT SWB sidewall bracket can be used in place of any sidewall or marriage line bracket that is rated at or below 3150 lbs. working load.

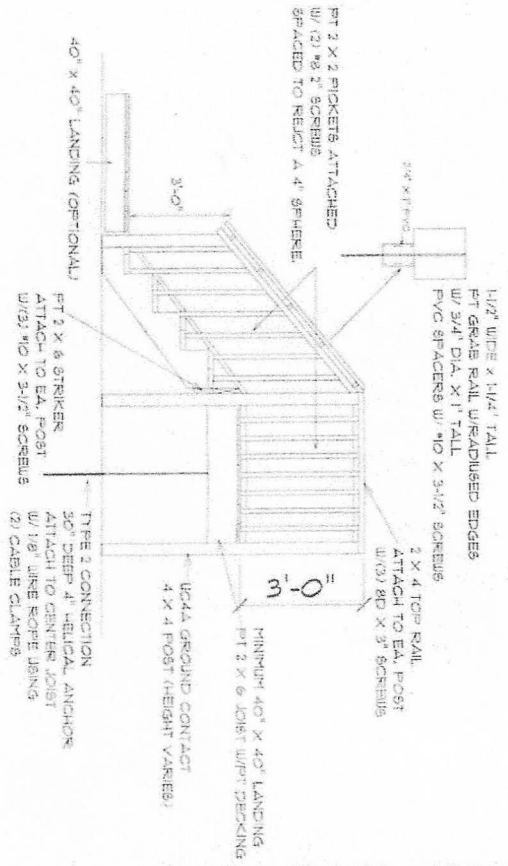

40" X 40" STEPS
SCALE 3/4" = 1'-0"

- NOTES:
1. STEPS HAVE A MIN. 40" X 40" LANDING
 2. STEPS HAVE A RISER HEIGHT OF BETWEEN 6.75" TO 1.75"
 3. HANDRAIL HEIGHT 36"
 4. STEPS TO HAVE MIN. 10" TREAD DEPTH.
 5. PICKETS TO BE SPACED TO REJECT A 4" SPHERE.
 6. STEPS TO MEET TREAD TO RISER RATIO- 2 RISES + 1 TREAD = 24" - 25"
1. FLIGHT OF STAIRS NOT TO HAVE VERTICAL RISES GREATER THAN 12' BETWEEN LANDINGS.

Ray E. Risner
 RAY E. RISNER P.E. #33724
 P.O. BOX 3
 SUWANNEE, FL. 32692
 352-318-1356

STEP RITE SOLUTIONS

PHONE:
 FAX:
 MOBILE:

SECTION LETTER
 A
 11
 PAGE NUMBERS

DRAWN BY: DKF
 SCALE: 3/4" = 1'-0"
 DATE: Wednesday, November 6, 2024

PAGE:
 1/2
 40 INCH STEPS

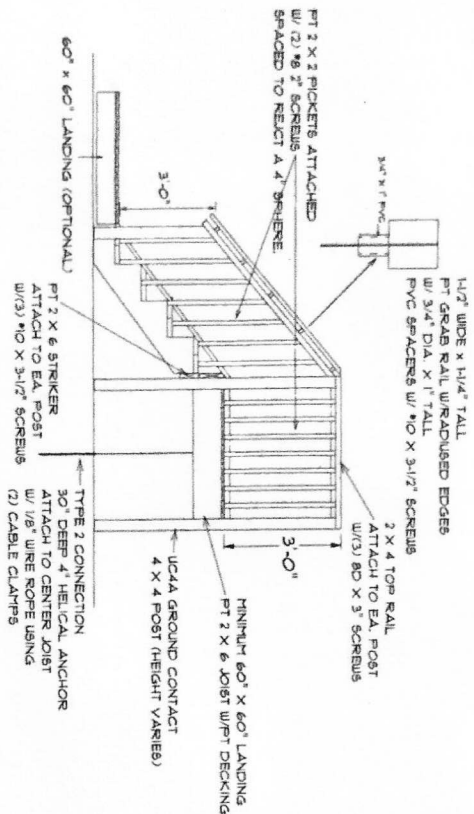

60" x 60" STEPS
SCALE 3/4" = 1'-0"

- NOTES:
1. STEPS HAVE A MIN. 60" X 60" LANDING
 2. STEPS HAVE A RISER HEIGHT OF BETWEEN 6.75" TO 7.75"
 3. HANDRAIL HEIGHT 36"
 4. STEPS TO HAVE MIN. 10" TREAD DEPTH,
 5. PICKETS TO BE SPACED TO REJECT A 4" SPHERE
 6. STEPS TO MEET TREAD TO RISER RATIO - 2 RISES + 1 TREAD = 24" - 25"
1. FLIGHT OF STAIRS NOT TO HAVE VERTICAL RISES GREATER THAN 12' BETWEEN LANDINGS.

Paul E. Risner
11/11/24
PROFESSIONAL ENGINEER
STATE OF FLORIDA

RAT E RISNER P.E. #33174
PO BOX 3
GULFANNEE, FL. 32692
352-318-1356

STEP RITE SOLUTIONS
PHONE:
FAX
MOBILE:

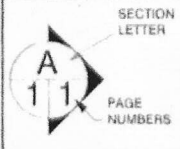

SECTION LETTER
DRAWN BY: DKF
SCALE 3/4" = 1'-0"
DATE Wednesday, November 6, 2024

PAGE:
2 / 2
60 INCH STEPS

Vinyl Skirting Installations

Installation Details

Careful attention to a few basic details will insure that your vinyl skirting will provide a beautiful, easily installed, completely accessible exterior with a minimum of maintenance. Vinyl skirting is easily installed over any terrain, requires no special tools and never needs painting. Following these basic installation techniques will assure that our skirting will contribute to the beauty of your home's exterior.

Tools you will need

Hammer • Screwdriver • Snips • Plumb Bob or Level • Tape Measure
Power Saw with Fine Tooth Blade • Snap Lock Tool • Chalk Line
• Utility Knife

Important

- 1) Use either a power saw with a fine tooth blade mounted with reverse rotation, or aviation snips to cut skirting components.
- 2) To allow for normal expansion and contraction, fasten the Top Trim Back component(s) in the center of the nailing slots. Fasten positively to the surface of the unit at every slotted hole, leaving 1/2" between lengths. **Do not butt the ends.** Overlap the Top Trim Front component(s) approximately 1" at joints. Allow 1/2" between pieces of the Bottom Channel component(s) when installing.
- 3) **Do not drive the fasteners too tightly.** Nails or screws offer excellent holding power, but if driven too tightly, the vinyl can, under normal expansion and contraction, become distorted. These fasteners should be driven in the middle of the nailing slot just short of touching the Top Trim Back component(s). Nail or screw to achieve 3/4" penetration into a solid wood substance. Fasten to allow part to expand and contract during the normal change in ambient temperature. **Do not fasten tight.** Allow 1/16" gap between fastener head and part.

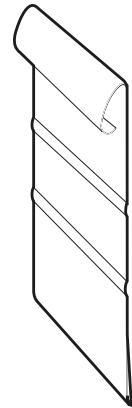

Top Trim Back Component

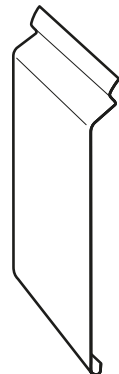

Top Trim Front Component

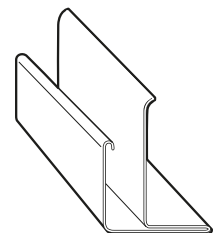

Bottom Channel Component

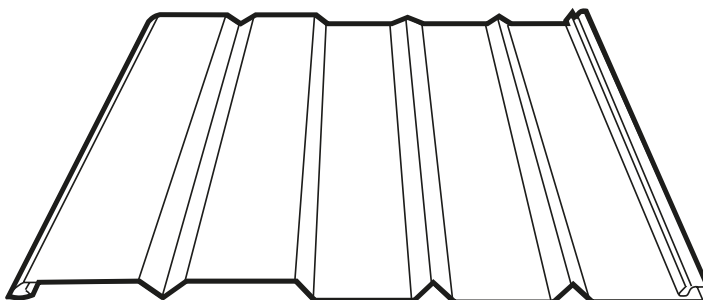

Skirting Panel

Vinyl Skirting Installations

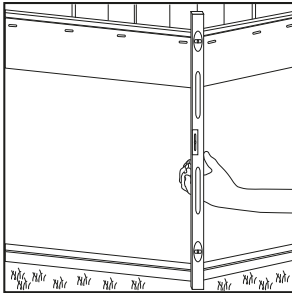

Figure 1

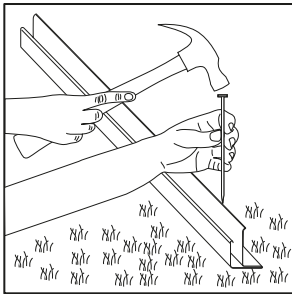

Figure 2

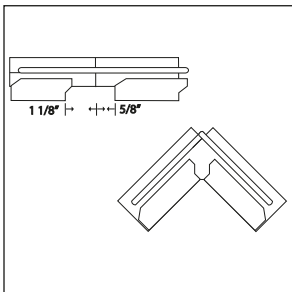

Figure 3

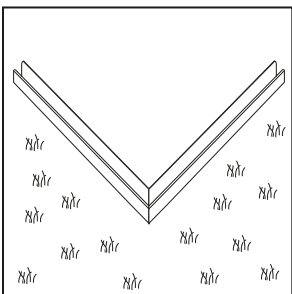

Figure 4

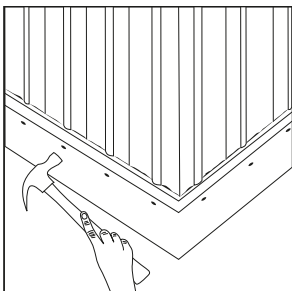

Figure 5

Step 1...

Laying the Bottom Channel Components

A level or plumb line should be used to establish the location of the Bottom Channel. The taller backside of the Bottom Channel should be located directly beneath the outside bottom edge of the home, where the Top Trim Back component will be attached (*see figure 1*). To prevent grass from growing around the base of the skirting and provide a non-shifting base for the ground spikes, 9" asphalt roof starter should be installed around the home. The roof starter also reduces the possibility of the vinyl skirting panels being damaged from the use of a powered string trimmer. "Weed-Eater" type trim units will damage the skirting and is not covered by the warranty.

Attach the Bottom Channel component directly to the ground through the prepunched holes (*see figure 2*). Spikes are required every 24 inches...extra holes are provided in the Bottom Channel component for convenience. Another spike or a drift punch may be used to drive spikes in completely. To allow for expansion, leave a 1/2" gap between each section of the Bottom Channel component. To form clean, attractive corners, the Bottom Channel component can be notched with snips (*see figure 3*) and then bent to the desired angle. (*Attached to the ground as shown in figure 4*).

Note: in high wind areas; where ground below the unit is spongy; or where ground is loose from recent excavation and has not yet settled, it is advisable to fasten bottom channel to treated wooden stakes. For installation on concrete, use 3/4" masonry nail instead of ground spike. "Liquid Nail" cement or other similar methods of setting a fastener directly to concrete can also be used.

Step 2...

Mounting Top Trim Back Components

First determine where the Top Trim Back component(s) will mount on the lower part of the home. The bottom edge of the Top Trim Back component can extend below the bottom edge of the home if there is a solid support for nailing and a solid bearing for the Top Trim Front component against the side of the home. It is helpful to mark a line around the bottom of the home with a chalk line or other method to assure a straight line where the Top Trim Back component is to be installed.

The Top Trim Back component is installed by driving the fasteners in the middle of every slot (*see figure 5*). **Do not fasten tightly!** (see fastening instructions on front page.) **Do not cut Top Trim Back components at the corners.** Gently bend over a sharp edge of a cutting table or a similar surface to form a corner (*see figure 6*).

If the installation is made in extremely cold weather, the vinyl should be warmed to room temperature before bending. Warming will avoid the likelihood of cracking.

Step 3...

Cutting Top Trim Back Components

The Top Trim Back component is constructed with two parallel ridges at intervals below the nailing slots (see figure 7). These ridges may be used to measure the distance from the ground to the lower ridge. In cold weather, measure to the top ridge; In warm weather, measure to the bottom ridge. If the ground is level, several panels may be cut at one time using a hand power saw. **Remember, if a power saw is to be used, mount a fine-toothed blade in reverse position** (see figure 8).

Locking the Skirting Panels

A snap lock tool is used to punch locking tabs on the outside bottom edge of each skirting panel (see figure 9). When the panel is installed, it becomes locked in the Bottom Channel component. This feature assures retention of the panel in the Bottom Channel. **Note:** When installing in a high wind area, you may also punch locking tabs at the top of the panel for added locking strength.

Self-aligning panels easily snap and slide into place (see figure 10). Be certain that each skirting panel positively interlocks with the skirting panel adjoining it.

Note: (above 36" panel height, a framing support system should be considered.)

Installing the Skirting Panels

Panel can be installed by setting into the Bottom Channel and leaning against the top trim back. Lock the next panel as shown in figure 10. Panels should not be cut but bent around corners as shown in figure 11.

Fitting Skirting Panels Around Service Connections

Cutting and fitting to virtually any shape or radius is easily done with Vinyl Skirting. Using aviation snips, cut the panel to fit around the connection. Cut the panel from the side – **not from the top or bottom**. Keep snip points open as if cutting cloth to avoid cracking panels.

CAUTION

Proper installation of manufactured home skirting requires that the Top Back component be fastened loosely so the panel will slide freely in the nail slots. This can be accomplished by leaving the fastener 1/16" to 1/8" from the face of the panel. The fastener must penetrate a solid surface by 3/4".

Do not place outdoor cookers near the vinyl skirting because the heat will distort the panels. Any heat source must be kept away from the panels or damage may occur.

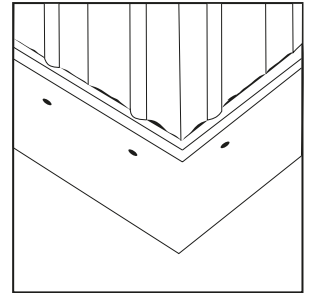

Figure 6

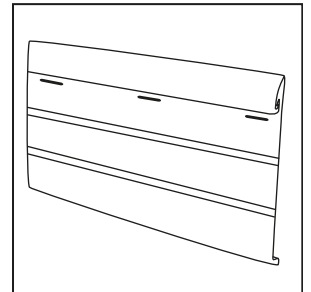

Figure 7

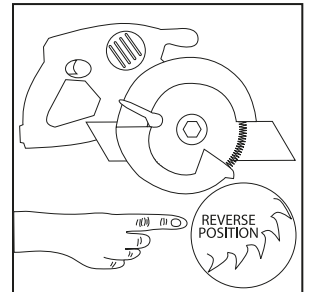

Figure 8

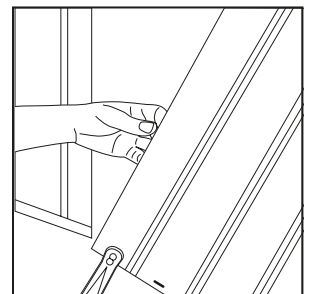

Figure 9

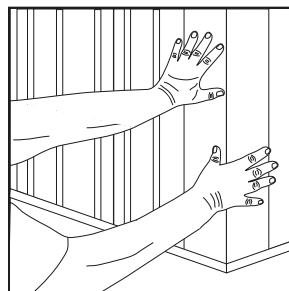

Figure 11

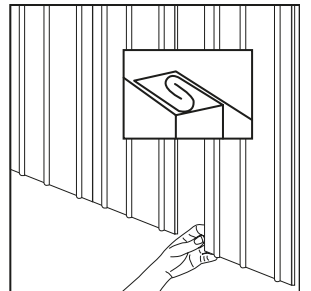

Figure 10

Vinyl Skirting Installations

Step 4...

Installing the Top Trim Front Component

The Top Trim Front component(s) installs easily by snapping the top edge of its spring lock into the installed Top Trim Back component. Be sure to push the Top Trim Front component all the way into the Top Trim Back component **until it “snaps” into place.**

Each of the 15 pieces of the Top Trim Front components in the trim kit are notched 2" on one end (see figure 12) to permit overlapping. Overlap ends of adjoining Top Trim Front component(s) approximately 1".

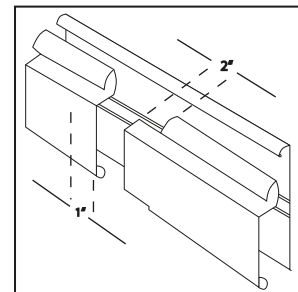

Figure 12

Cutting Additional Corners

If inside corners are needed, trim strips can be easily cut with aviation snips to form attractive corner joints by cutting a 45° mitre on adjacent ends and butting. If extra outside corners are required (for porches or add-on rooms), notch the trim strips as shown (see figure 13), bend around the corner and snap into place. Allow at least 3' of trim strip on each side of the corner.

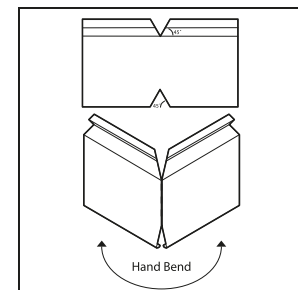

Figure 13

Easy Access

Access can be gained at virtually any point by simply lifting the Top Trim Front component and sliding out the desired number of panels. Accessibility to the area under the unit is available whenever desired.

Final Configuration

Please review the drawing to the right that shows how the components and skirting panels look after installation is complete.

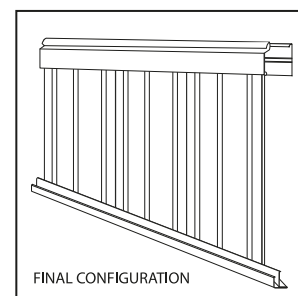
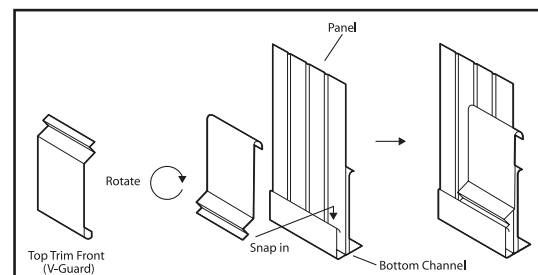

Figure 14

V-Guard Installation - (if applicable)

Installing the V-Guard Component

V-Guard Vinyl Skirting Protector component(s) installs easily by snapping the bottom edge of its spring lock into the Bottom Channel component. Be sure to push the V-Guard trim all the way into the Bottom Channel component **until it “snaps” into place.** (see figure 14)



Cutting additional corners

If inside corners are needed, V-Guard trim can be easily cut with aviation snips to form attractive corner joints by cutting a 45° mitre on adjacent ends and butting. If extra outside corners are required (for porches or add-on rooms), notch the V-Guard trim component, bend around the corner and snap into place. Allow at least 3" of V-Guard component trim on each side of the corner.



Style Crest, Inc.
2450 Enterprise St.
Fremont, Ohio 43420
800.945.4440
www.stylecrestproducts.com