

CROSS SECTION AT INT'R. PARTITION
 FRAME LINE: (Typ of 23)
 ALL PARTITION COL'S (PC*) ARE 4X20C16
 ALL SIDEWALL COL'S (SCI) ARE 4X20C16

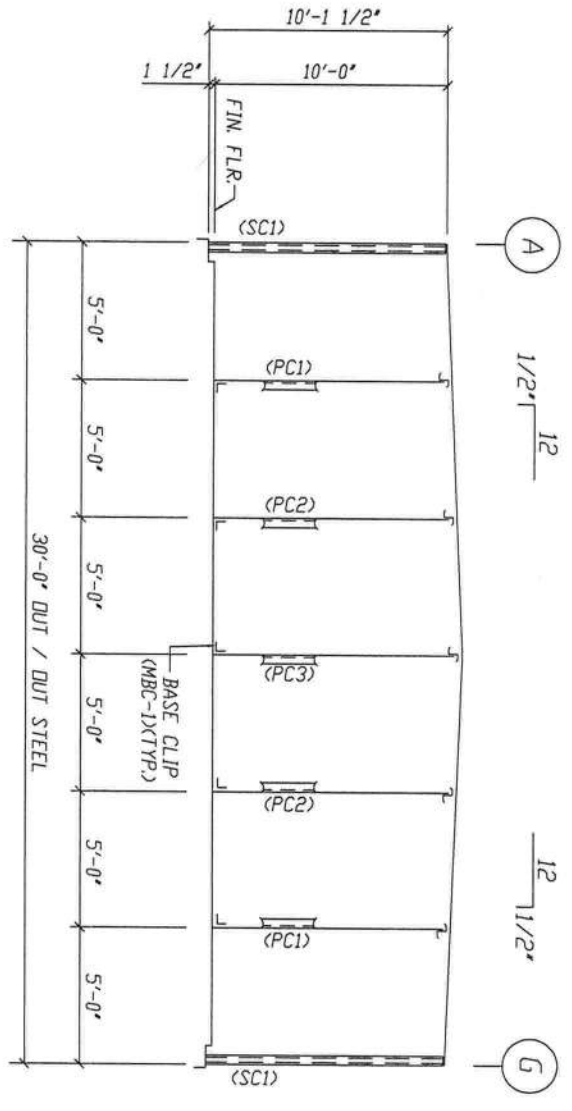

CROSS SECTION AT INT'R. PARTITION
 FRAME LINE: 55
 ALL PARTITION COL'S (PC*) ARE 4X20C16
 ALL SIDEWALL COL'S (SCI) ARE 4X20C16

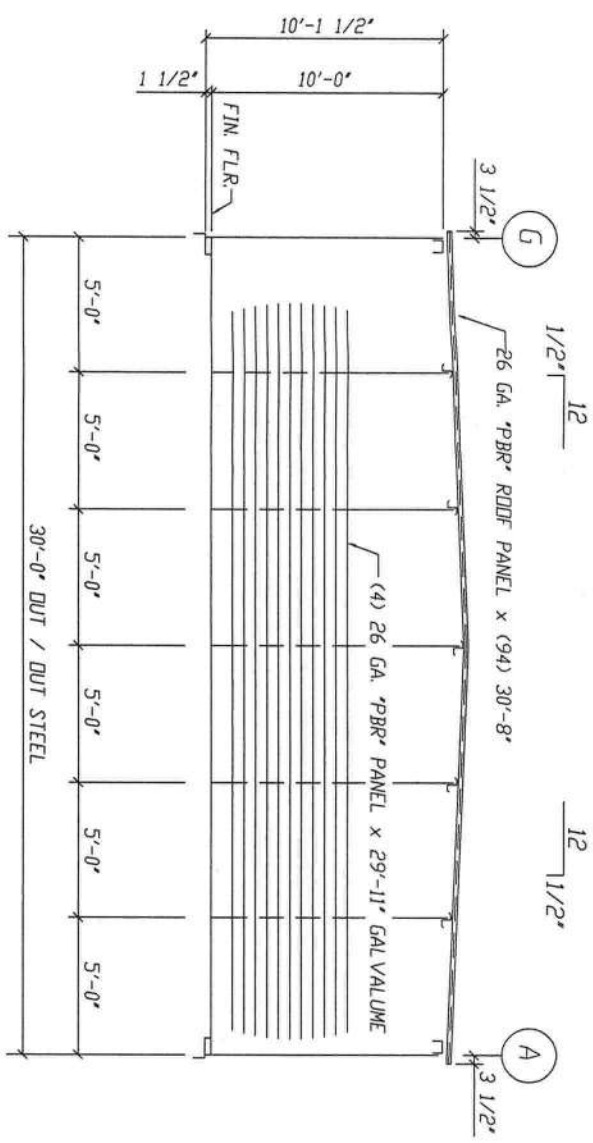

SHEETING AT 30'-0" PARTITION
 FRAME LINE: (Typ of 23)
 WALL SHEETED ON BOTH SIDES @ LINE 9, 25 & 41

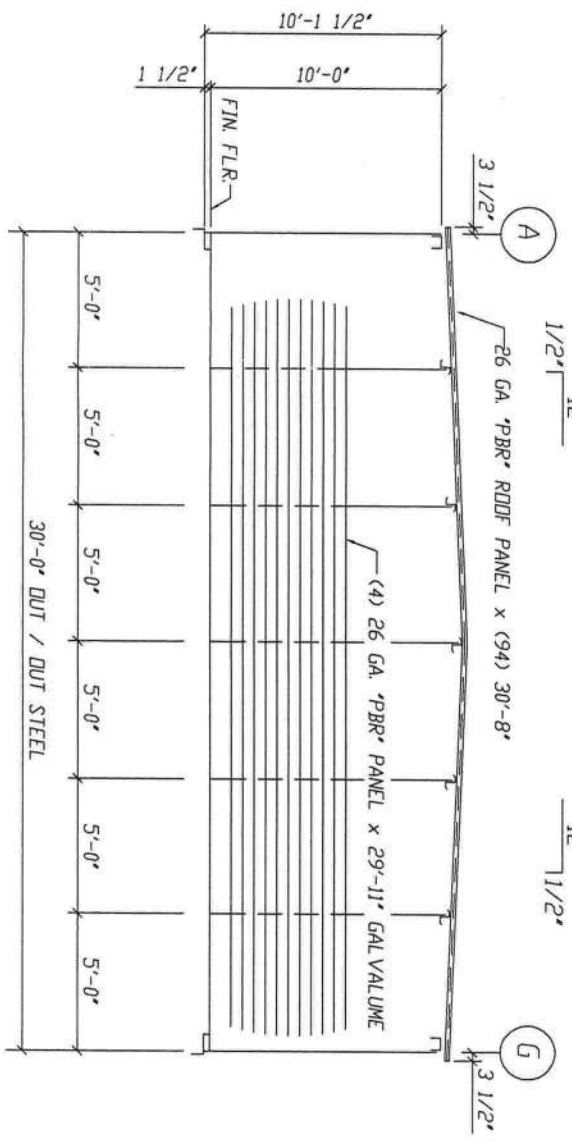

SHEETING AT 30'-0" PARTITION
 FRAME LINE: 55

MEMBER TABLE		
PARTITION WALL		
MARK	PART	LENGTH
SCI	4X20C16	10'-1 1/4"
PC1	4X20C16	10'-2"
PC2	4X20C16	10'-4 1/2"
PC3	4X20C16	10'-7"

REVISIONS				
REV.	DESCRIPTION	DATE	DTLR	CHKR

DRAWING STATUS				
<input type="checkbox"/>	FINAL ERECTION			
<input type="checkbox"/>	FOR CONSTRUCTION			
<input type="checkbox"/>	FOR APPROVAL			

APPLICATION OF SEAL IS FOR METAL BUILDING ONLY AND DOES NOT REPRESENT THE PROFESSIONAL OF RECORD.

VULCAN STEEL STRUCTURES, INC	
PROJECT	BUILDING #900
ID	27611
PROJECT	

MINI-STORAGE & RECORD STORAGE OF LAKE CITY	
DESIGN: VB	DRAFT: KVB
CHECK: VB	
DATE: 05/12/22	SHEET

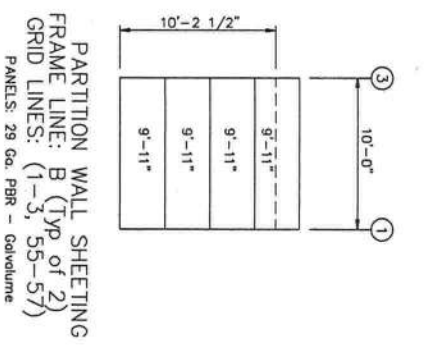
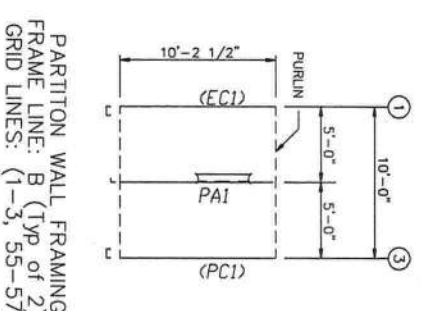
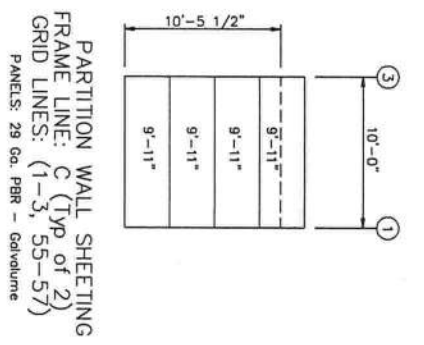
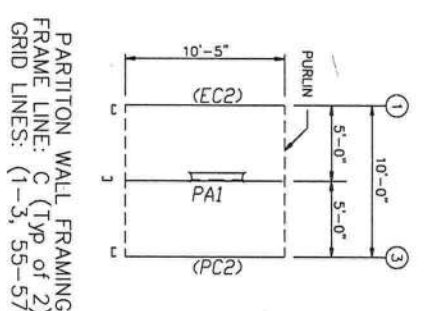
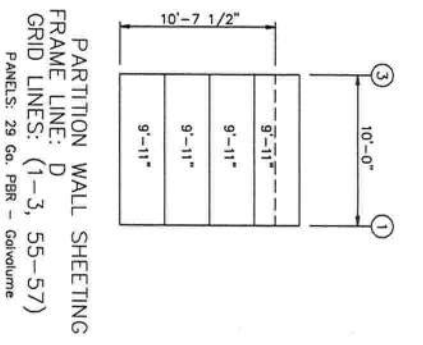
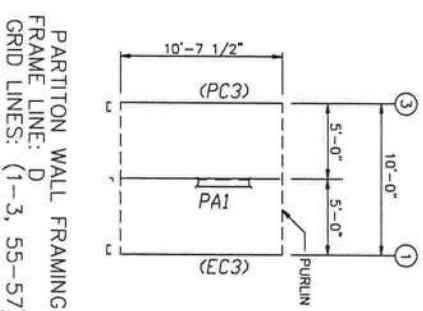

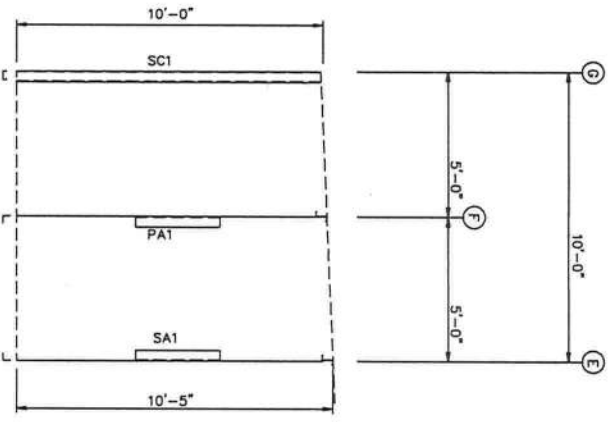

PARTITION WALL FRAMING
 FRAME LINE: 4 (Typ of 22)
 GRID LINES: (4-24)

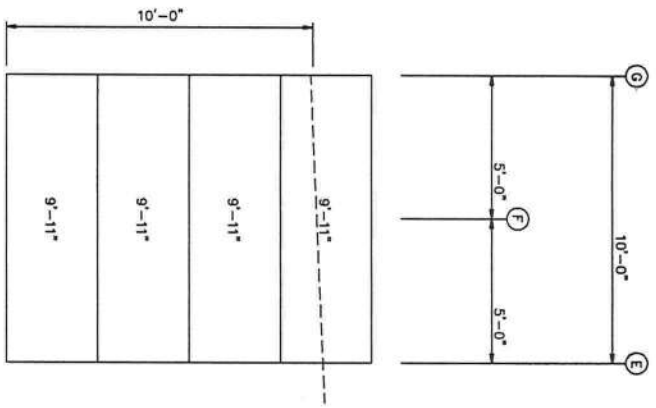

PARTITION WALL SHEETING
 FRAME LINE: 4 (Typ of 22)
 GRID LINES: (4-24)
 PANELS: 29 Ga. PBR - Galvalume

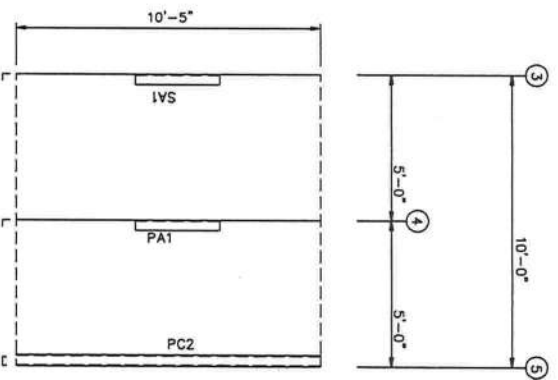

PARTITION WALL FRAMING
 FRAME LINE: E (Typ of 23)
 GRID LINES: (3-55)

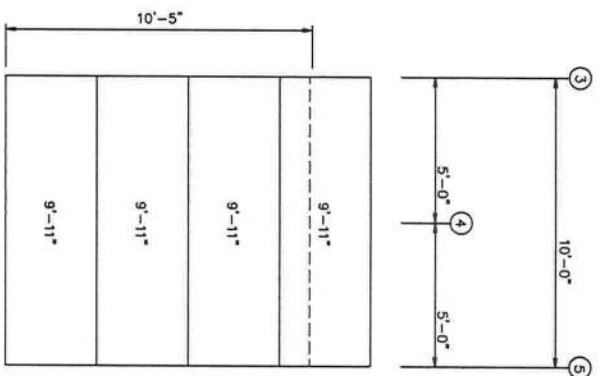

PARTITION WALL SHEETING
 FRAME LINE: E (Typ of 23)
 GRID LINES: (3-55)
 PANELS: 29 Ga. PBR - Galvalume

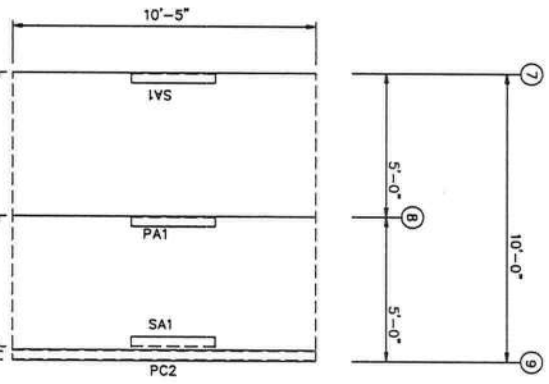

PARTITION WALL FRAMING
 FRAME LINE: E (Typ of 3)
 GRID LINES: (23-25)(39-41)

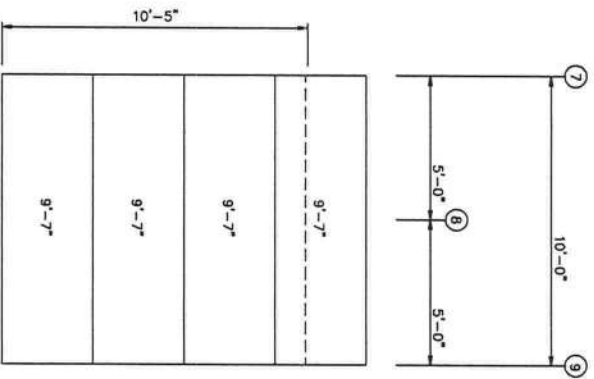

PARTITION WALL SHEETING
 FRAME LINE: E (Typ of 3)
 GRID LINES: (23-25)(39-41)
 PANELS: 29 Ga. PBR - Galvalume

REVISIONS				
REV.	DESCRIPTION	DATE	DTLR	CHKR

DRAWING STATUS
 FINAL ERECTION
 FOR CONSTRUCTION
 FOR APPROVAL

VULCAN STEEL STRUCTURES, INC
 PROJECT BUILDING #900
 ID 27611
 PROJECT | AKF CITY, FL 32025

ORIGINAL SIGNATURE REQUIRED

MINI-STORAGE & RECORD STORAGE
 ENDWALL DRAWING
 DESIGN VB DRAFTI. KVB CHECKI. VB
 DATE: 05/12/22 SHEET E10

SEAL

VANESSA L. BANKS
 LICENSE
 No. 83970
 STATE OF FLORIDA
 PROFESSIONAL ENGINEER

5/12/22

