

RIGHT ELEVATION
SCALE: 1/4" = 1'-0"

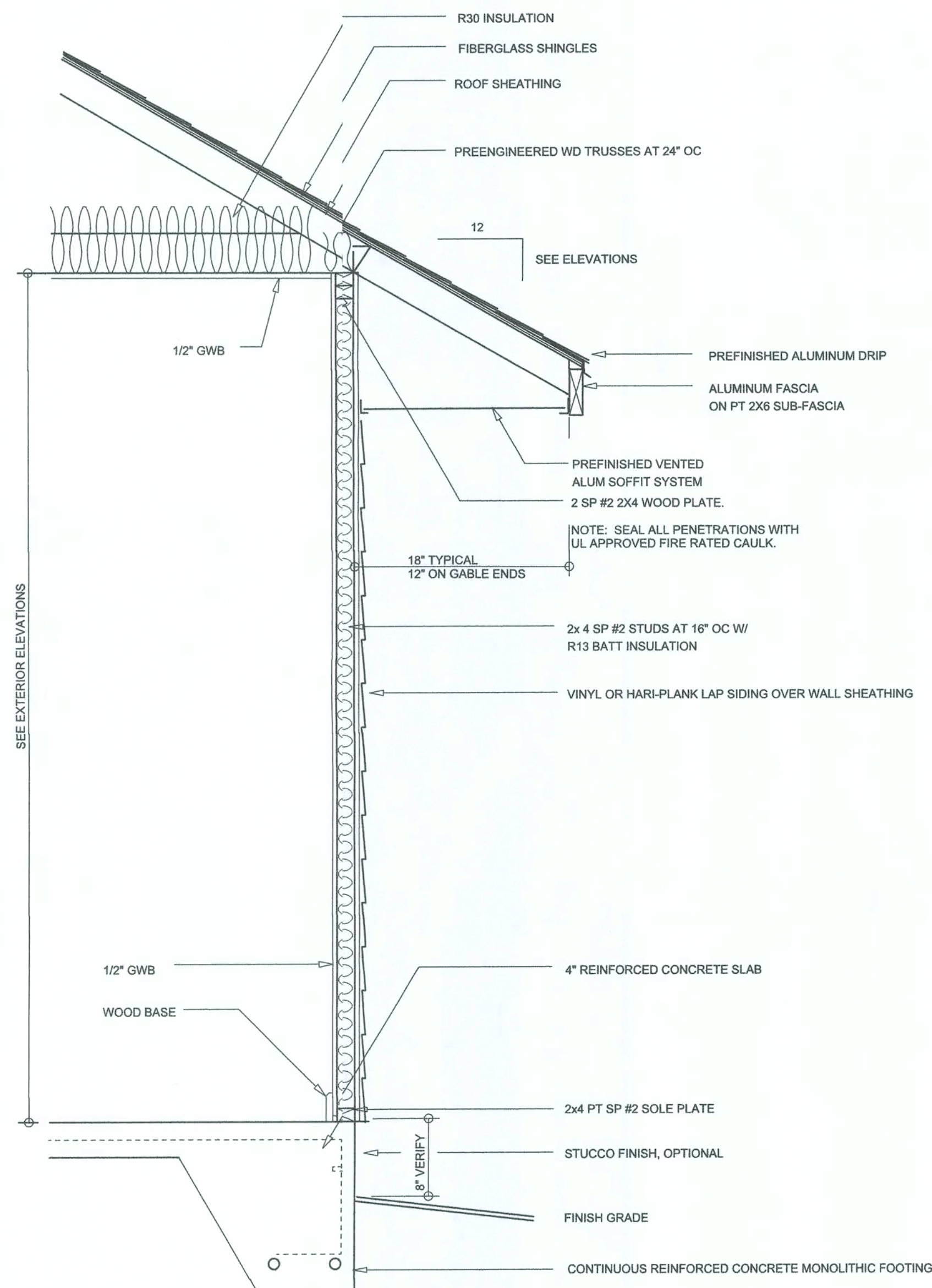

LEFT ELEVATION
SCALE: 1/4" = 1'-0"



TYPICAL WALL SECTION
SCALE: 1" = 1'-0"



REAR ELEVATION
SCALE: 1/4" = 1'-0"



FRONT ELEVATION
SCALE: 1/4" = 1'-0"



SOFTPLAN
ARCHITECTURAL DESIGN SOFTWARE

EXTERIOR ELEVATIONS
SCALE: 1/4" = 1'-0"
TYPICAL WALL SECTION
SCALE: 1" = 1'-0"

A RENTAL HOME FOR:
ANDREW SCHNEIDER
PROJECT ADDRESS: 577 QUARTS GLEN, COLUMBIA COUNTY, FLORIDA

©WILLIAM MYERS
DESIGN INC
P.O. BOX 1513
LAKE CITY, FL 3206
(386) 758-8416
wll@willmyers.net

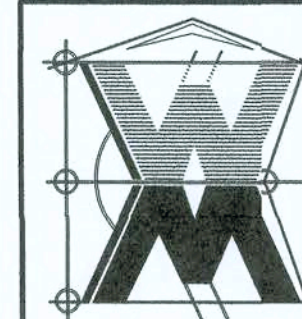

JOB NUMBER
090101

SHEET NUMBER
A.1
OF 2 SHEETS



William Myers

NOTE: ALL DRAWINGS NOT TO BE SCALED, WRITTEN DIMENSIONS TAKE PRECEDENCE OVER SCALED DIMENSIONS

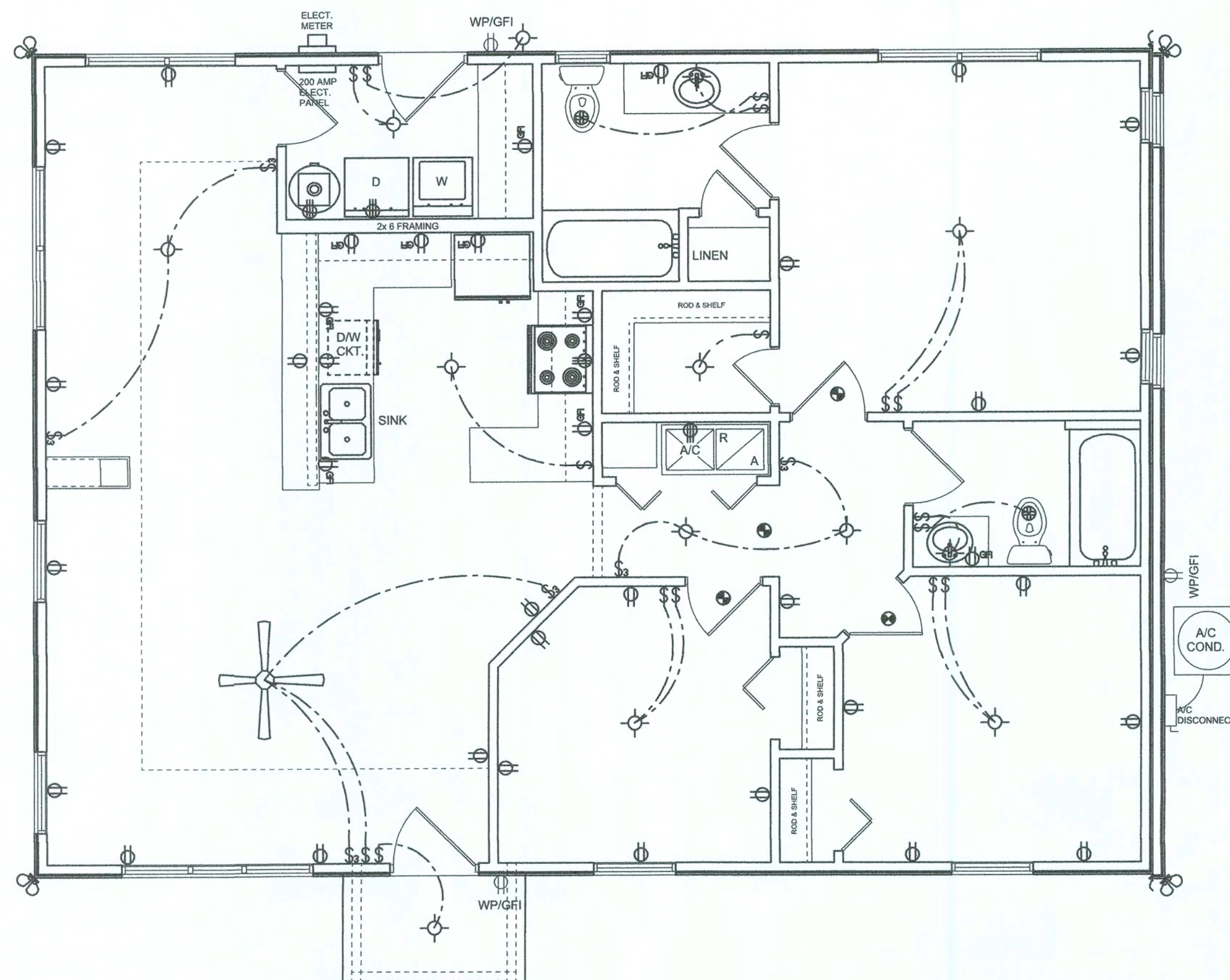

ELECTRICAL PAN
SCALE: 1" = 1'-0"

ELECTRICAL LEGEND	
	CEILING IN (PRE-WIF FOR LIGHT KIT)
	DOUBLE SECURITY LIGHT
	RECESSED CAN LIGHT
	BATH EXHAUST FAN
	LIGHT FIXTURE
	DUPLEX OUTLET
	220V OUTLET
	GFI DUPLEX OUTLET
	TELEVISION JACK
	TELEPHONE JACK
	SMOKE DETECTOR (see note below)
	WALL SWITCH
	3 WAY WALL SWITCH
	WATER PROOF GFI OUTLET
	2 OR 4 TL FLUORESCENT FIXTURE

NOTE:
ALL BEDROOM RECEPTACLES SHALL BE AFCI (ARC FAULT CIRCUIT INTERRUPT)

ALL SMOKE DETECTORS SHALL HAVE BATTERY BACKUP POWER AND ALL WIRED TOGETHER SIF ANY ONE UNIT IS ACTUATED THEY ALL ACTIVATE.

THE ELECTRICAL SERVICE OCCURRENT PROTECTION DEVICE SHALL BE INSTALLED ON THE EXTERIOR STRUCTURES TO SERVE AS A DISCONNECT MEANS. CONDUCTORS USED FROM THE EXTERIOR DISCONNECTING MEANS TO A PANEL OR SUB PANEL SHALL HAVE FOUR-WIRE CONDUCTORS, OF WHICH ONE CONDUCTOR SHALL BE USED AS AN EQUIPMENT GROUND.

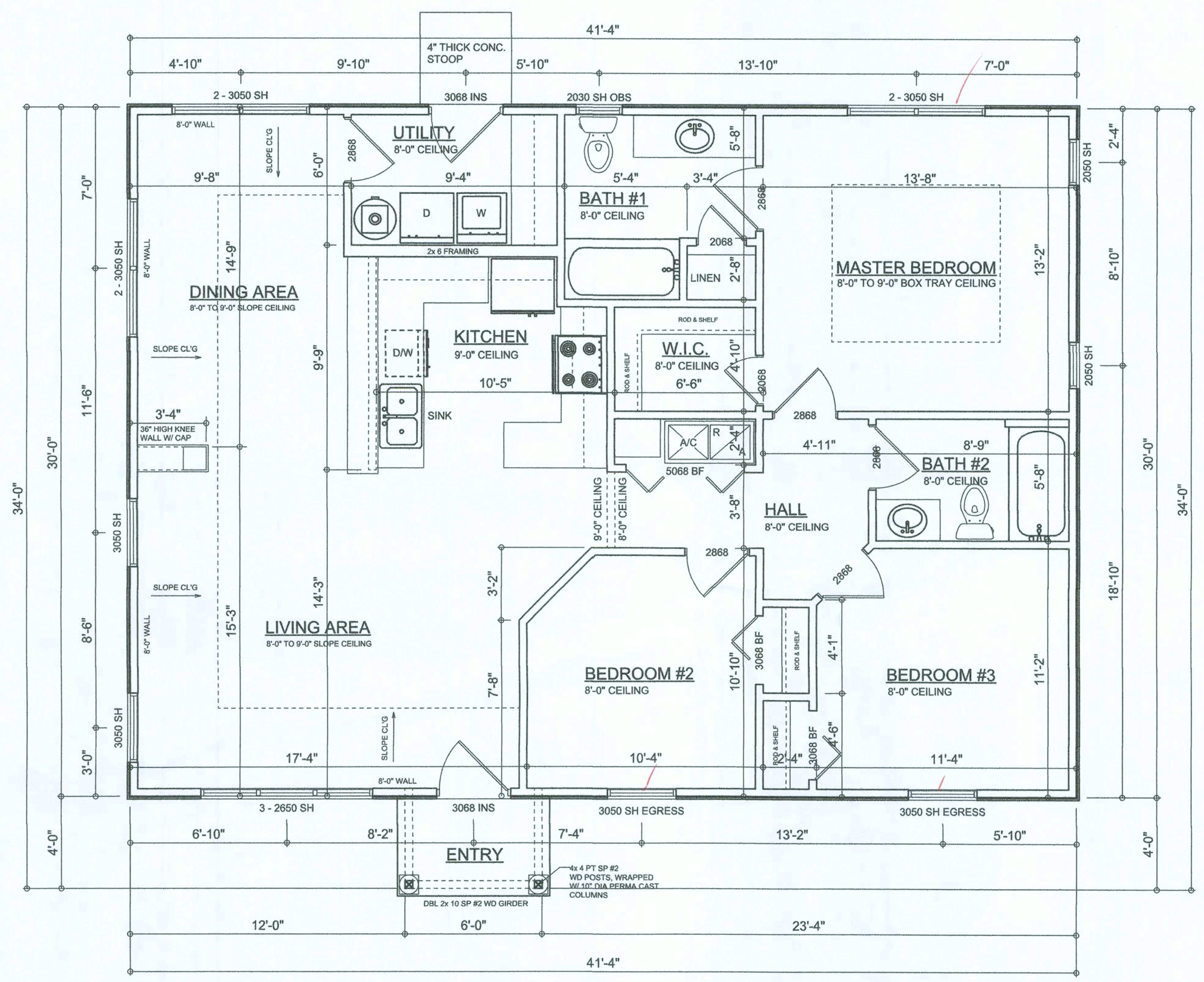

FLOOR PLAN
SCALE: 1/4" = 1'-0"

ALL CEILING HEIGHTS SHALL BE 8'-0" UNLESS OTHERWISE NOTED

Garage fire separations shall comply with the following:

- The private garage shall be separated from the dwelling unit and its attic area by means of a minimum 1/2-inch (12.7 mm) gypsum board applied to the garage side. Garages beneath habitable rooms shall be separated from all habitable rooms above by not less than 5/8-inch Type X gypsum board or equivalent. Door openings between a private garage and the dwelling unit shall be equipped with either solid wood doors, or solid or honeycomb core steel doors not less than 1 3/8 inches (34.9 mm) thick, or fire doors in compliance with Section 715.3.3. Openings from a private garage directly into a room used for sleeping purposes shall not be permitted.
- Ducts in a private garage and ducts penetrating the walls or ceilings separating the dwelling unit from the garage shall be constructed of a minimum 0.019-inch (0.48 mm) sheet steel and shall have no openings into the garage.
- A separation is not required between a Group R-3 and U carport provided the carport is entirely open on two or more sides and there are not enclosed areas above.
- When installing an attic access and/or pull-down stair unit in the garage, devise shall have a minimum 20 min. fire rating.

AREA SUMMARY

LIVING AREA	1240	S.F.
ENTRY PORCH AREA	24	S.F.
TOTAL AREA	1264	S.F.

REVISIONS
January 08, 2009

SOFTPLAN
ARCHITECTURAL DESIGN SOFTWARE

FLOOR PLAN
SCALE: 1/4" = 1'-0"

ELECTRICAL PAN
SCALE: 1/4" = 1'-0"

A RENTAL HOME FOR:
ANDREW SCHNEIDER
PROJECT ADDRESS: SW COATS GLEN, COLUMBIA COUNTY, FLORIDA

© WILLIAM MYERS
DESIGN INC.
P.O. BOX 1513
LAKE CITY, FL 3266
(386) 758-8406
will@willmyers.net

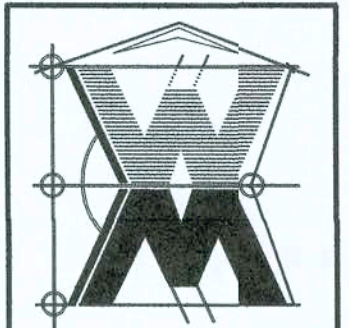

JOB NUMBER
090101

SHEET NUMBER

A.2
OF 2 SHEETS

NOTE: ALL DRAWINGS NOT TO BE SCALED, WRITTEN DIMENSIONS TAKE PRECEDENCE OVER SCALED DIMENSIONS

William Myers

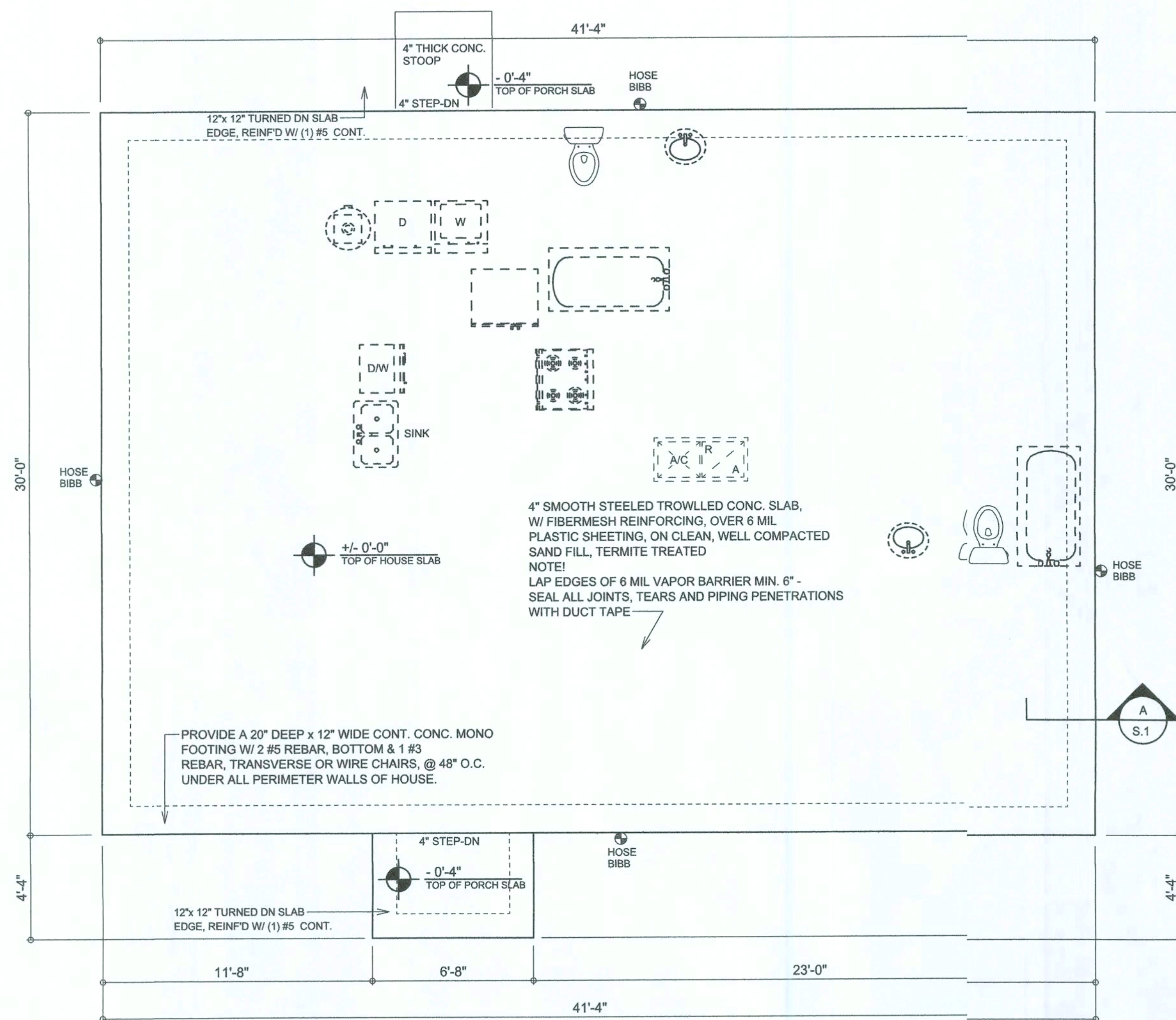

FLOOR PLAN
SCALE: 1/4" = 1'-0"

CONCRETE / MASONRY / METALS GENERAL NOTES:

- DESIGN SOIL BEARING PRESSURE: 1000 PSF.
- EXPANSIVE SOILS: WHERE DIRECTED BY THE SOILS ENGINEER, SOIL AUGMENTATION PER THE SOILS ENGINEER'S SPECIFICATIONS SHALL BE IMPLEMENTED PRIOR TO PLACING ANY FOUNDATIONS - TESTS AS SPECIFIED SHALL BE PERFORMED TO DETERMINE THE SUITABILITY OF THE SUB-GRADE TO SUPPORT THE DESIGN LOADS.
- CLEAN SAND FILL OVER STRIPPED AND COMPACTED EXISTING GD. SHALL BE PLACED IN 12" LIFTS. BOTH SUB-SOIL AND FILL COMPACTION SHALL BE NOT LESS THAN 98% AS MEASURED BY A MODIFIED PROCTOR TEST AT THE RATE OF ONE TEST FOR EACH 1500 SF OF BUILDING PAD AREA, OR FRACTION THEREOF, FOR EACH 12" LIFT.
- REINFORCING STEEL SHALL BE GRADE 60 AND MEET THE REQUIREMENTS OF ASTM A615, ALL BENDS SHALL BE MADE COLD.
- WELDED WIRE MESH SLAB REINFORCING SHALL MEET THE REQUIREMENTS OF ASTM A185 - MIN. YIELD STRESS = 85 KSI.
- CONCRETE SHALL BE STANDARD MIX F_c = 3000 PSI FOR ALL FTGS, SLABS, COLUMNS AND BEAMS OR SHALL BE STANDARD PUMP MIX F_c = 3000 PSI. STRENGTH SHALL BE ATTAINED WITHIN 28 DAYS OF PLACEMENT. MIXING, PLACING AND FINISHING SHALL BE AS PER ACI STANDARDS.
- CONCRETE BLOCK SHALL BE AS PER MANUFACTURER'S PRODUCT GUIDE FOR ASTM C-90 REQUIREMENTS WITH MEDIUM SURFACE FINISH - F_m = 1500 PSI.
- MORTAR SHALL BE TYPE "M" OR "N" FOR ALL MASONRY UNITS.
- STRUCTURAL STEEL SHALL CONFORM TO ASTM A36 STANDARDS FOR STRENGTH, BOLTS SHALL BE ASTM A307 / GRADE 1 OR A325, AS PER PLAN REQUIREMENTS.
- WELDS SHALL BE AS PER "AMERICAN WELDING SOCIETY" STANDARDS FOR STRUCTURAL STEEL APPLICATIONS.
- 2X4 P/T WOOD SILL, CONT., ALL AROUND, W/ 5/8" - A.B. W/ 3" SQ. X 1/4" PLATE WASHERS WITHIN 6" FROM EACH CORNER, EA. WAY, & WITHIN 6" FROM ALL WALL OPENINGS / ENDS - 12" - A.B. W/ 2" SQ. WASHERS ALONG EACH RUN @ 48" O.C., MAX. - ALL ANCHOR BOLTS SHALL HAVE A MINIMUM OF 8" EMBEDMENT INTO THE CONCRETE.

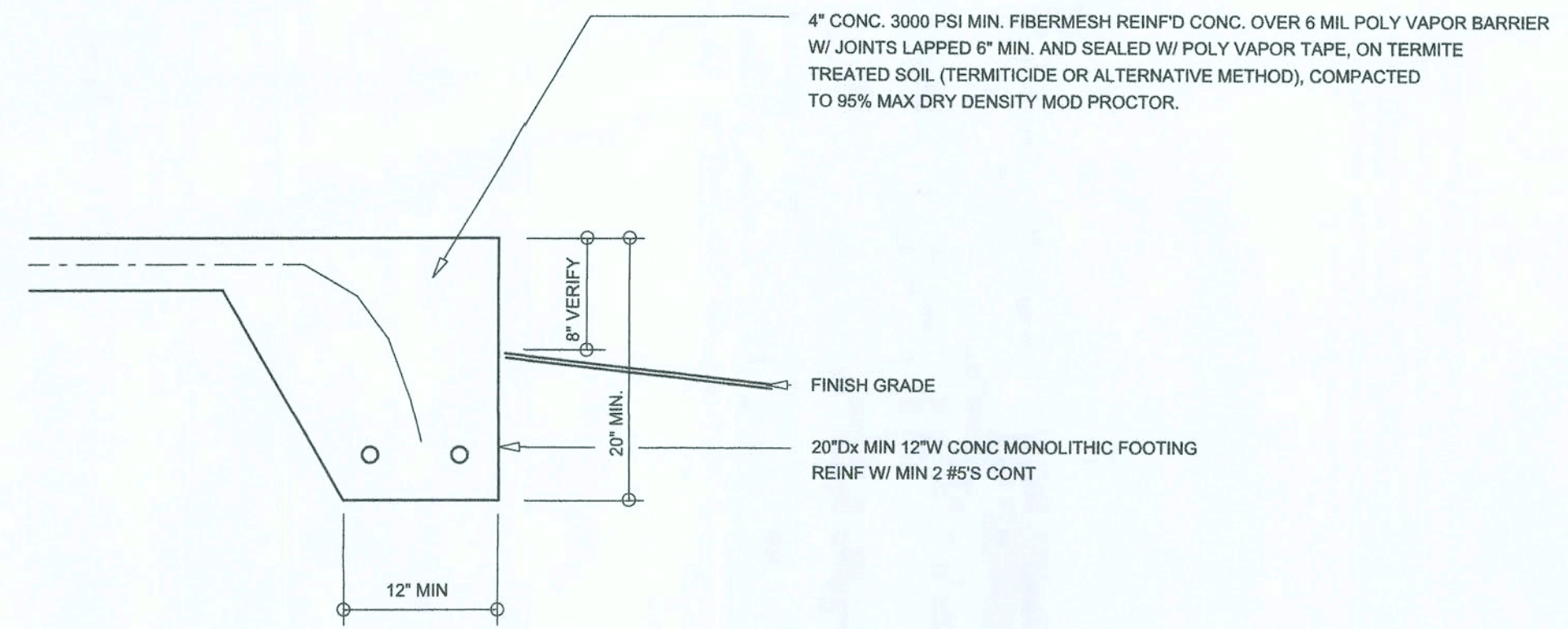

SECTION A
SCALE: 3/4" = 1'-0"
S.1

NOTE:
THE DESIGN WIND SPEED FOR THIS PROJECT IS 110 MPH PER 2007 FBC 1609 AND LOCAL JURISDICTION REQUIREMENTS

NOTE:
ADDED FILL SHALL BE APPLIED IN 8" LIFTS - EA. LIFT SHALL BE COMPACTED TO 98% DRY COMPACTION PER THE "MODIFIED PROCTOR" METHOD.

NOTE:
PLUMBING CONTRACTOR SHALL PREPARE "AS-BUILT" SHOP DRAWINGS INDICATING ALL PLUMBING WORK, INCLUDING ALL PLUMBING LINE LOCATIONS AND RISER DIAGRAM - CONTR SHALL PROVIDE 1 COPY OF AS-BUILT DWGS TO OWNER AND 1 COPY TO THE PERMIT ISSUING AUTHORITY.

NOTE:
H.V.A.C. CONTRACTOR SHALL PREPARE "AS-BUILT" SHOP DRAWINGS INDICATING ALL H.V.A.C. WORK, INCLUDING ALL DUCTWORK LOC., SIZES, LINES, EQUIPMENT SCH. & BALANCING REPORT - CONTR SHALL PROVIDE 1 COPY OF AS-BUILT DWGS TO OWNER & 1 COPY TO THE PERMIT ISSUING AUTHORITY.

NOTE!
PRIOR TO THE CONSTRUCTION OF THE FOUNDATION, THE CONTRACTOR SHALL COORDINATE ANY INTERIOR BEARING LOCATION CONDITIONS PER THE TRUSS ENGINEERED SHOP DRAWINGS WITH THE FOUNDATION PLAN. ANY INTERIOR BEARING LOCATIONS OR ANY POINT LOADS OF 4.0 K OR GREATER SHALL BE SUPPORTED VIA A MODIFIED FOUNDATION PLAN TAKING THESE LOADS INTO CONSIDERATION. THE CONTRACTOR SHALL MAKE THE ENGINEERED TRUSS SHOP DRAWINGS AVAILABLE TO THE ARCHITECT FOR THE PURPOSE OF RENDERING SUCH MODIFICATIONS PRIOR TO POURING ANY CONCRETE.

NOTE: ALL DRAWINGS NOT TO BE SCALED, WRITTEN DIMENSIONS TAKE PRECEDENCE OVER SCALED DIMENSIONS

REVISIONS
January 08, 2009

FOUNDATION PLAN
SCALE: 1/4" = 1'-0"

A RENTAL HOME FOR:
ANDREW SCHNEIDER
PROJECT ADDRESS: SW COATS GLEN, COLUMBIA COUNTY, FLORIDA



NE
NICHOLS
LAB
LAK
BLANK
BLANK
ARCHITECT
M.C.A.R.B. Certified

JOB NUMBER
090101

SHEET NUMBER
S.1
OF 4 SHEETS

THE CONTRACTOR SHALL COORDINATE THE TRUSS TO TRUSS ANCHOR REQUIREMENTS WITH THE TRUSS ENGINEERING SHOP DRAWINGS. SOME OF THE TRUSS TO TRUSS CONNECTIONS WILL REQUIRE ANCHOR STRAPS IN ADDITION TO TYPICAL NAILING. ANCHOR DEVICES SHALL BE REQUIRED FOR ALL JOINTS WITH AN UPLIFT OR GRAVITY LOAD OF 100 LBS OR GREATER.

TRUSSES BEARING ON INTERIOR PARTITIONS WHERE UPLIFT LOADS ARE PRESENT SHALL REQUIRE ANCHORS OF EQUAL OR GREATER LOAD CAPACITY THAN THAT INDICATED BY THE TRUSS SHOP DRAWINGS. THE UPLIFT ANCHOR SYSTEM SHALL BE CONTINUOUS TO THE FOUNDATION.

SHOP DRG COORDINATION: THE TRUSS ANCHOR STRAPS AS INDICATED IN THE CONSTRUCTION DOCUMENTS ARE SUGGESTED STRAPS AND THAT THE TRUSS ENGINEERED SHOP DRAWING LOADS TAKE PRECEDENCE OVER THAT INDICATED IN THE CONSTRUCTION DOCUMENTS. THE UPLIFT LOADS INDICATED FOR EACH TRUSS IN THE ENGINEERED TRUSS SHOP DRAWINGS MAY BE MATCHED TO STANDARD PRODUCT UPLIFT RATINGS FOR COMPARABLE UPLIFT CONNECTORS, AND THAT THE PRODUCTS THAT PROVIDE EQUAL OR GREATER UPLIFT RESISTANCE FOR THE LISTED LOADS MAY BE USED IN LIEU OF THOSE INDICATED IN THE CONSTRUCTION DOCUMENTS OR AS APPROVED BY THE BUILDING OFFICIAL.

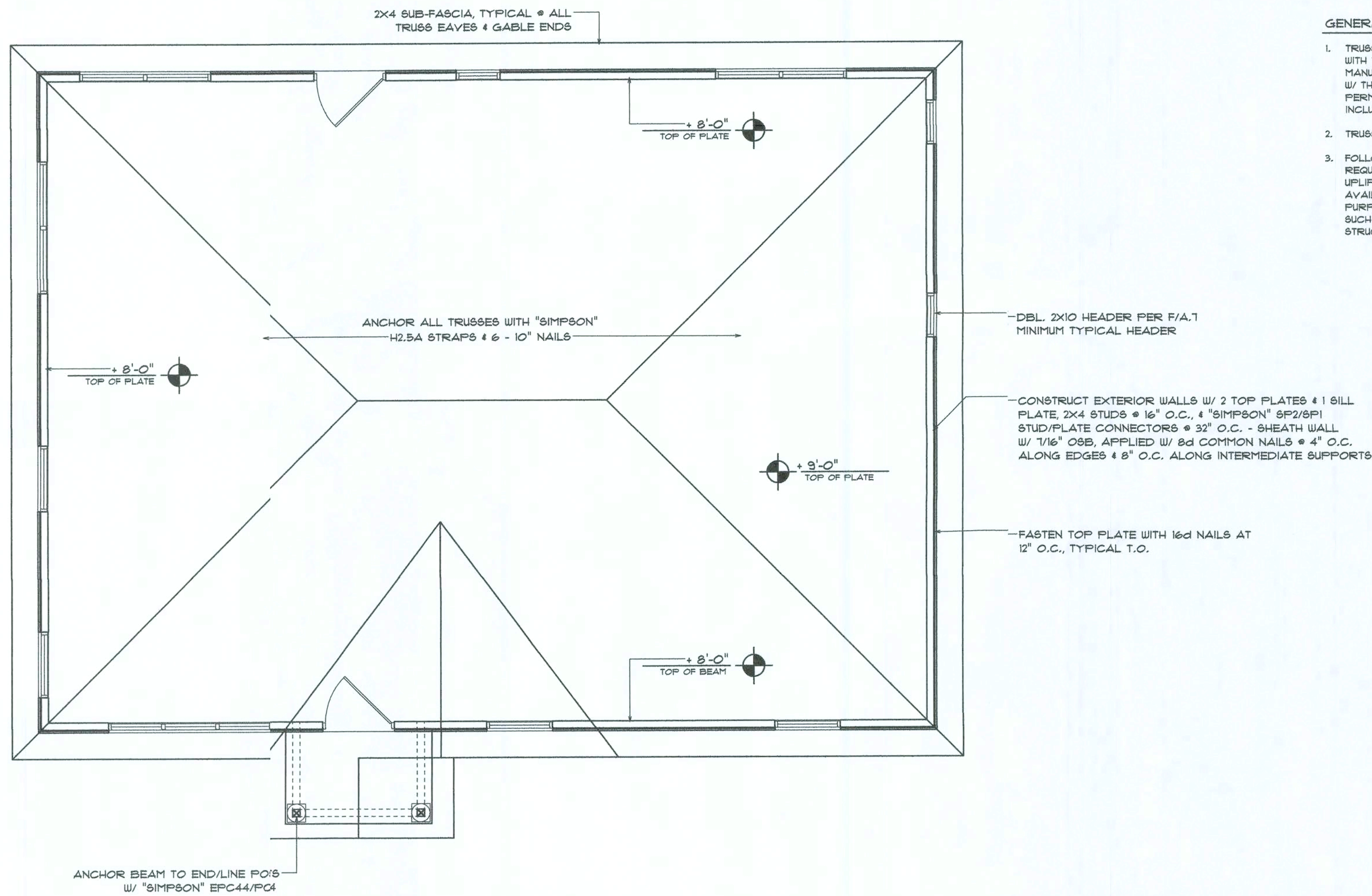

Roof Framing PLAN

SCALE: 1/4" = 1'-0"

NOTE:
ANCHOR GIRDER TRUSSES TO HEADS WITH 2 "SIMPSON" LST2, 3 OR 4).
ANCHOR HEADER TO KING STUDS W/ 2 "SIMPSON" ST22 EA. END - TYP., T.O.

NOTE:
REFER TO THE WINDOW/DOOR HEADER SCHEDULE ON SHEET SD.4 FOR ALL MINIMUM SIZE HEADERS AND ALTERNATE MINIMUM SIZE ALLOWABLE IS 2X10.

PROJECT COORDINATION REQUIREMENTS

NOTICE 1
THESE PLANS ARE DRAWN FOR AVERAGE SITE CONDITIONS AND COMPLIANCE WITH APPLICABLE CODES IN LAKE CITY, FL AT THE TIME THEY ARE DRAWN. DUE TO VARYING STATE, LOCAL, AND NATIONAL CODES, RULES AND REGULATIONS, N.P.GEBLER, ARCHITCT CANNOT WARRANT COMPLIANCE WITH ALL APPLICABLE STATE, LOCAL, AND NATIONAL CODES IN YOUR AREA OR WITH YOUR PARTICULAR SITE CONDITIONS. IT IS THE RESPONSIBILITY OF THE PURCHASER AND/OR BUILDER TO SEE THAT THE STRUCTURE IS BUILT IN STRICT COMPLIANCE WITH ALL GOVERNING MUNICIPAL CODES (CITY, COUNTY, STATE, AND FEDERAL). IF YOUR CITY OR STATE REQUIRES AN ENGINEER'S SEAL FOR THE SITE/CIVIL PORTIONS OF THE WORK, YOU WILL NEED TO HAVE THAT DONE LOCALLY BY A QUALIFIED, LICENCED PROFESSIONAL ENGINEER.

ROOF PLAN NOTES

- R-1 SEE EXTERIOR ELEVATIONS FOR ROOF PITCH
- R-2 ALL OVERHANG 18" UNLESS OTHERWISE NOTED
- R-3 PROVIDE ATTIC VENTILATION IN ACCORDANCE WITH SCHEDULE ON SD.3
- R-4 SEE EXTERIOR ELEVATIONS AND FLOOR PLANS TO VERIFY PLATE AND HEEL HEIGHTS
- R-5 MOVE ALL VENTS AND OTHER ROOF PENETRATIONS TO REAR

NOTE:
SHEATH ROOF W/ 1/2" CDX PLYWOOD PLACED W/ LONG DIMENSION PERPENDICULAR TO THE ROOF TRUSSES, SECURE TO FRAMING W/ 8d NAILS - AS PER DETAIL ON SHEET SD.4

NOTE:
THE DESIGN WIND SPEED FOR THIS PROJECT IS 110 MPH PER 2001 FBC 1603 AND LOCAL JURISDICTION REQUIREMENTS

NOTE:
ALL PENETRATIONS OF THE TOP PLATE OF ALL LOAD BEARING WALLS SHALL BE SEALED WITH FIRE RETARDANT CAULKING, INCLUDING WIRING, PLUMBING OR OTHER SUCH PENETRATIONS. WALLS OVER 8'-0" TALL SHALL HAVE CONTINUOUS BLOCKING TO LIMIT CAVITY HEIGHT TO 8'-0". PENETRATIONS THROUGH SUCH BLOCKING SHALL BE TREATED IN THE SAME MANNER AS TOP PLATES, NOTED ABOVE

GENERAL TRUSS NOTES:

1. TRUSSES SHALL BE DESIGNED BY A LICENCED ENGINEER, AND IN ACCORDANCE WITH THE REQUIREMENTS OF THE "NATIONAL FOREST PRODUCTS ASSOCIATION" MANUAL FOR "STRESS RATED LUMBER AND ITS CONNECTIONS", LATEST Ed., ALONG W/ THE "TRUSS PLATE INSTITUTE" SUGGESTED GUIDELINES FOR TEMPORARY AND PERMANENT BRACING, AND HANDLING OF TRUSSES. TRUSS SHOP DRAWINGS SHALL INCLUDE TRUSS DESIGN, PLACEMENT PLANS, DETS, & TRUSS TO TRUSS CONNECTIONS.
2. TRUSS SHOP DRAWINGS SHALL BE SIGNED & SEALED BY THE DESIGNING ENGINEER.
3. FOLLOWING DEVELOPMENT OF TRUSS SHOP DRAWINGS, ADJUSTMENTS TO THE ANCHOR REQUIREMENTS MAY BE REQUIRED DEPENDING ON THE ENGINEERED GRAVITY AND WIND UPLIFT REQUIREMENTS OF TRUSSES OR GIRDERS. THE CONTRACTOR SHALL MAKE AVAILABLE A COMPLETE SET OF TRUSS SHOP DRAWINGS TO THE ARCHITECT FOR THE PURPOSE OF REVIEW OF LOADS IMPOSED ON THE BALANCE OF THE STRUCTURE. ANY SUCH REQUIRED CHANGE SHALL BE INCORPORATED INTO THE CONSTRUCTION OF THIS STRUCTURE.

WOOD STRUCTURAL NOTES

1. TEMPORARY BRACING OF THE STRUCTURE DURING ERECTION, REQUIRED FOR SAFE AND STABLE CONSTRUCTION, SHALL BE THE SOLE RESPONSIBILITY OF THE CONTRACTOR SO ENGAGED. TEMPORARY & PERMANENT BRACING OF ROOF TRUSSES SHALL BE AS PER THE STANDARD GUIDELINES OF THE "TRUSS PLATE INSTITUTE".
2. ALL TRUSSES SHALL BE DESIGNED BY A LICENCED PROFESSIONAL ENGINEER & SHALL BE SIGNED AND SEALED BY SAME. TRUSS DESIGN SHALL INCLUDE PLACEMENT PLANS, TRUSS DETAILS, TRUSS TO TRUSS CONNECTIONS & THE STANDARD SPECIFICATIONS & RECOMMENDATIONS OF INSTALLATION OF THE "TRUSS PLATE INSTITUTE".
3. WOOD STUDS IN EXTERIOR WALLS & INTERIOR BEARING WALLS SHALL BE NOT LESS THAN N.2 HEM-FIR OR BETTER.
4. CONNECTORS FOR WOOD FRAMING SHALL BE GALVANIZED METAL OR BLACK METAL AS MANUFACTURED OR AS CALLED FOR IN THE PLANS AND BE OF A DESIGN SUITABLE FOR THE LOADS AND USE INTENDED. REFER TO THE JOINT REINFORCEMENT SCHEDULE FOR PRINCIPLE CONNECTIONS.

AREA OF ATTIC	REQ'D LF. OF VENT	NET FREE AREA OF INTAKE
1600 SF	20 LF	410 SQ.IN.
1800 SF	24 LF	490 SQ.IN.
2200 SF	28 LF	570 SQ.IN.
2500 SF	32 LF	650 SQ.IN.
2800 SF	36 LF	730 SQ.IN.
3100 SF	40 LF	820 SQ.IN.
3600 SF	44 LF	900 SQ.IN.

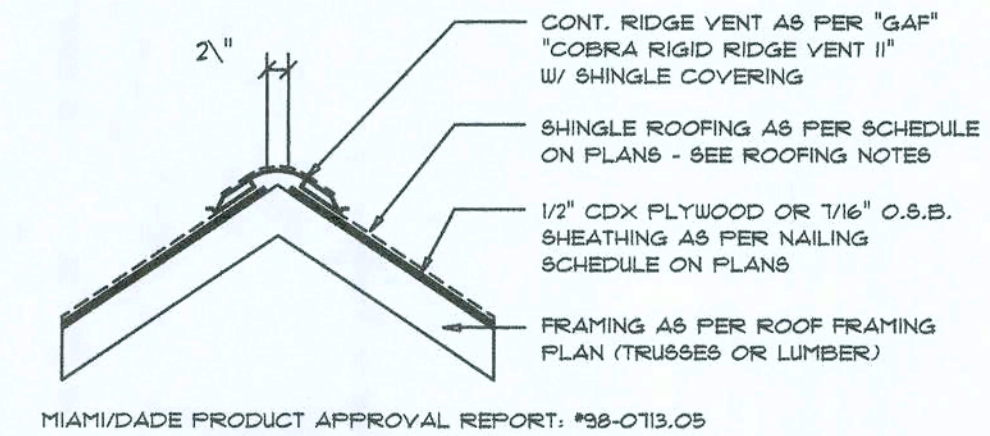

Ridge Vent DETAIL

SCALE: 3/4" = 1'-0"

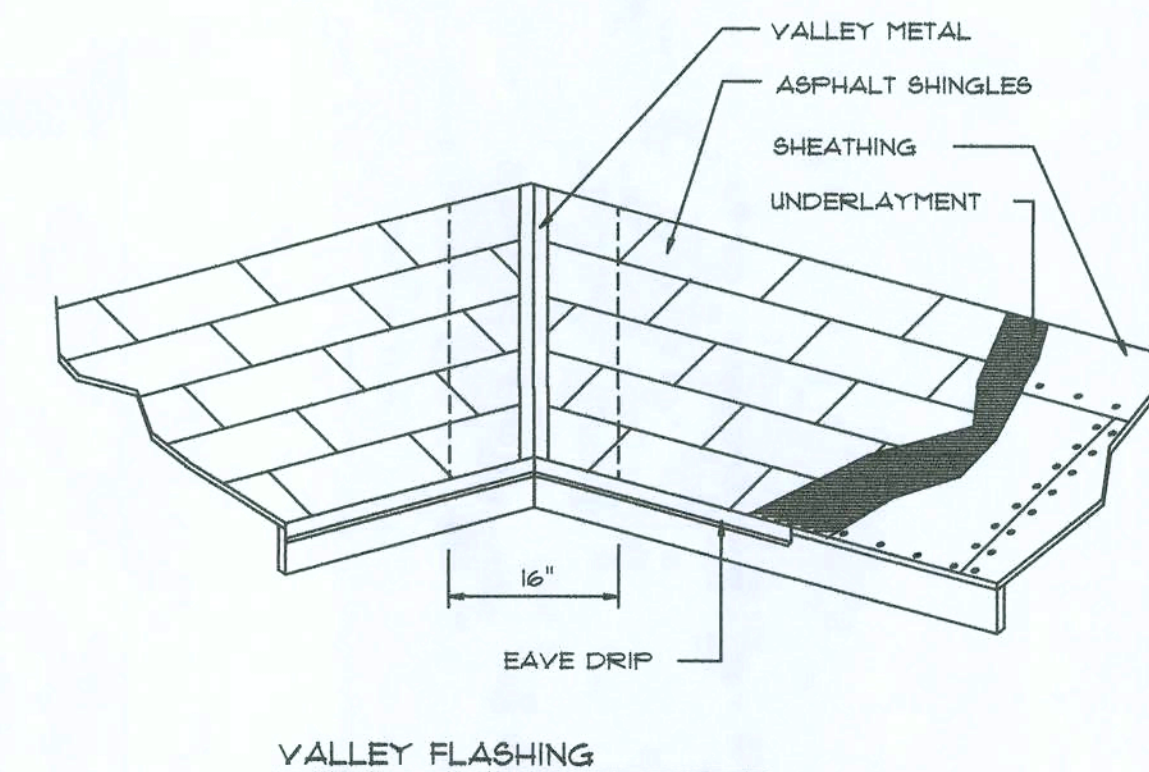

ROOFING METALS for FLASHING/ROOFING MINIMUM THICKNESS REQUIREMENTS			
MATERIAL	MINIMUM THICKNESS (in)	GAGE	WEIGHT (OZ.)
COPPER			16
ALUMINUM	0.024		
STAINLESS STEEL		28	
GALVANIZED STEEL	0.0175	26 (ZINC COATED G90)	
ZINC ALLOY LEAD PAINTED TERNE	0.021		40 20

Roofing/Flashing DETS.

SCALE: NONE

NOTE: ALL DRAWINGS NOT TO BE SCALED, WRITTEN DIMENSIONS TAKE PRECEDENCE OVER SCALED DIMENSIONS

REVISIONS
January 08, 2009

SOFTPLAN
ARCHITECTURAL DESIGN SOFTWARE

ROOF PLAN
SCALE: 1/4" = 1'-0"

A RENTAL HOME FOR:
ANDREW SCHNEIDER
PROJECT ADDRESS: SW COATS GLEN, COLUMBIA COUNTY, FLORIDA

AR0007005

NICHOLAS
CECILIA
ARCHITECT
M.C.A.R.B. Certified

1756 NW Bayview Rd.
Lake City, FL 32055
(386) 755-5021

JOB NUMBER
090101

SHEET NUMBER
S.2
OF 4 SHEETS

FLORIDA BUILDING CODE

Compliance Summary

TYPE OF CONSTRUCTION

Roof: Hip Construction, Wood Trusses @ 24" O
 Walls: 2x4 Wood Studs @ 16" O.C.
 Floor: 4" Thk. Concrete Slab W/ Fibermesh Concrs Additive
 Foundation: Continuous Footer/Stem Wall

ROOF DECKING

Material: 1/2" CD Plywood or 7/16" O.S.B.
 Sheet Size: 48"x96" Sheets Perpendicular to Rf Framing
 Fasteners: 8d Common Nails per schedule on stst A.7

SHEARWALLS

Material: 1/2" CD Plywood or 7/16" O.S.B.
 Sheet Size: 48"x96" Sheets Placed Vertical
 Fasteners: 8d Common Nails @ 4" O.C. Edges 8" O.C. Interior
 Dragstrut: Double Top Plate (S.Y.P.) W/16d Ns @ 12" O.C.
 Wall Studs: 2x4 Hem Fir Studs @ 16" O.C.

HURRICANE UPLIFT CONNECTORS

Truss Anchors: SEMCO HDPT2 @ Ea. Truss E (Typ. U.O.N.)
 Wall Tension: Wall Sheathing Nailing is Adeque - 8d @ 4" O.C. Top & Bot.
 Anchor Bolts: 1/2" A307 Bolts @ 48" O.C. - 18" off 6" from corner
 Corner Hold-down Device: (1) HD5a @ eh corner
 Porch Column Base Connector: Simpson J44/ABU66 @ each column
 Porch Column to Beam Connector: Simpa EPC44/PC44 @ each column

FOOTINGS AND FOUNDATIONS

Footings: 20"x12" Cont. W/2-#5 Bars Cont. & 1-#4 Transverse @ 24" O.C.
 Stemwall: 8" C.M.U. W/1-#5 Vertical Dowel @ 48" C.

ALL WIND LOADS ARE IN ACCORDANCE WITH SECTION 1609, FLORIDA BUILDING CODE, 20 TH EDITION.	
BASIC WIND SPEED:	110 MPH
WIND IMPORTANCE FACTOR (I):	I = 1.00
BUILDING CATAGORY:	CATAGORY II
WIND EXPOSURE:	"B"
INTERNAL PRESSURE COEFFICIENT:	+/- 0.18
MWFRS PER TABLE 1606.2A (FBC 2004) DESIGN WIND PRESSURES:	ROOF: -23.1 PSF WALLS: +26.6 PSF EAVES: -32.3 PSF
COMPONENTS & CLADDING PER TABLES 1609.2B & 1609.2C (FBC 2007) DESIGN WIND PRESSURES:	OPNGS: +21.8 / -29.1 PSF EAVES: -68.3 PSF ROOF: +19.9 / -25.5 PSF

TERMITE PROTECTION NOTES:

- SOIL CHEMICAL BARRIER METHOD:
- A PERMANENT SIGN WHICH IDENTIFIES THE TERITE TREATMENT PROVIDER AND NEED FOR REINSPECTION AND TREATMENT CONTRACT RENEWAL SHALL BE PROVIDED. THE SIGN SHALL BE POSTED NEAR THE WATER HEATER OR ELECTRIC PANEL. FBC 104.2.6
 - CONDENSATE AND ROOF DOWNSPOUTS SHALL SCARGE AT LEAST 1'-0" AWAY FROM BUILDING SIDE WALLS. FBC 1503.4.4
 - IRRIGATION/SPRINKLER SYSTEMS INCLUDING ALRISERS AND SPRAY HEADS SHALL NOT BE INSTALLED WITHIN 1'-0" FROM BUILDING SIDE WALLS. FBC 1503.4.4
 - TO PROVIDE FOR INSPECTION FOR TERMITE INFESTATION, BETWEEN WALL COVERINGS AND FINAL EARTH GRADE SHALL NOT BE LESS THAN 6". EXCEPTION: PAINT AND DECORATIVE CEMENTIOUS FINISH LESS THAN 5/8" THICK ADHERED DIRECTLY TO THE FOUNDATION W.L. FBC 1403.1.6
 - INITIAL TREATMENT SHALL BE DONE AFTER ALL CAVATION AND BACKFILL IS COMPLETE. FBC 1816.1.1
 - SOIL DISTURBED AFTER THE INITIAL TREATMENT SHALL BE RETREATED INCLUDING SPACES BOXED OR FORMED. FBC 1816.2
 - BOXED AREAS IN CONCRETE FLOOR FOR SUBSEQUENT INSTALLATION OF TRAPS, ETC. SHALL BE MADE WITH PERMANENT METAL OR PLASTIC FORMS. PERMANENT FORMS MUST BE OF A SIZE AND DEPTH THAT WILL ELIMINATE THE DISTURBANCE OF SOIL AFTER THE ITIAL TREATMENT. FBC 1816.1.3
 - MINIMUM 6 MIL VAPOR RETARDER MUST BE INSTALLED TO PROTECT AGAINST RAINFALL DILUTION. IF RAINFALL OCCURS BEFORE VAPOR RETARDER PLACEMENT, RETREATMENT IS REQUIRED. 3C 1816.1.4
 - CONCRETE OVERPOUR AND MORTAR ALONG THE FOUNDATION PERIMETER MUST BE REMOVED BEFORE EXTERIOR SOIL TREATMENT. FBC 1816.1.5
 - SOIL TREATMENT MUST BE APPLIED UNDER ALL EXTERIOR CONCRETE OR GRADE WITHIN 1'-0" OF THE STRUCTURE SIDEWALLS. FBC 1816.1.6
 - AN EXTERIOR VERTICAL CHEMICAL BARRIER MUST BE INSTALLED AFTER CONSTRUCTION IS COMPLETE INCLUDING LANDSCAPING AND IRRIGATION. ANY SOIL DISTURBED AFTER THE VERTICAL BARRIER IS APPLIED, SHALL BE RETREATED. FBC 1816.1.6
 - ALL BUILDINGS ARE REQUIRED TO HAVE PER-CONSTRUCTION TREATMENT. FBC 1816.1.7
 - A CERTIFICATE OF COMPLIANCE MUST BE ISSUE TO THE BUILDING DEPARTMENT BY # LICENSED PEST CONTROL COMPANY BEFORE A CERTIFICATE OF OCCUPANCY WILL BE ISSUED. THE CERTIFICATE OF COMPLIANCE SHALL STATE: "THE BUILDING HAS RECEIVED A COMPLETE TREATMENT FOR THE PREVENTION OF SUBTERRANEAN TERMITES. THE TREATMENT IS IN ACCORDANCE WITH THE RULES AND LAWS OF THE FLORIDA DEPARTMENT CAGRICULTURE AND CONSUMER SERVICES". FBC 1816.1.7
 - AFTER ALL WORK IS COMPLETED, LOOSE WOOD AND FILL MUST BE REMOVED FROM BELOW AND WITHIN 1'-0" OF THE BUILDING. THIS INCLUDES ALL GRADE STAKES, TUB TRAP BOXES, FORMS, SHORING OR OTHER CELLULOSE CONTAINING MATERIAL. FBC 2303.1.3
 - NO WOOD, VEGETATION, STUMPS, CARDBOARD, RASH, ETC., SHALL BE BURIED WITHIN 15'-0" OF ANY BUILDING OR PROPOSED BUILDING. FBC 2303.1.4

FRAMING ANCHOR SCHEDULE

APPLICATION	MANUFR/MODEL	CAP.
TRUSS TO WALL:	SIMPSON H2.5A (OR EQUIVALENT), W/ 6 - 10d NAILS	960#
GIRDER TRUSS TO POST/HEADER:	SIMPSON LGT, W/ 28 - 16d NAILS	1785#
HEADER TO KING STUD(S):	SIMPSON ST22	1370#
PLATE TO STUD:	SIMPSON SP2	1065#
STUD TO SILL:	SIMPSON SP1	585#
PORCH BEAM TO POST:	SIMPSON PC44/EPC44	1700#
PORCH POST TO FND.:	SIMPSON ABU44	2200#
MISC. JOINTS	SIMPSON A34	315#/240#

NOTE:
 ALL ANCHORS SHALL BE SECURED W/ NAILS AS PRESCRIBED BY THE MANUFACTURER FOR MAXIMUM JOINT STRENGTH, UNLESS NOTED OTHERWISE.

NOTE:
 REFER TO THE INCLUDED STRUCTURAL DETAILS FOR ADDITIONAL ANCHORS/ JOINT REINFORCEMENT AND FASTENERS.

NOTE:
 ALL UNLISTED JOINTS IN THE LOAD PATH SHALL BE REINFORCED WITH SIMPSON A34 FRAMING ANCHORS, TYPICAL T.O.

NOTE:
 "SEMCO" PRODUCT APPROVAL:
 MIAMI/DADE COUNTY REPORT #95-5-0818.15

NOTE:
 "SIMPSON" PRODUCT APPROVALS:
 MIAMI/DADE COUNTY REPORT #97-7-0107.05, #96-1126.11, #99-0623.04
 SBCC1 NER-443, NER-393

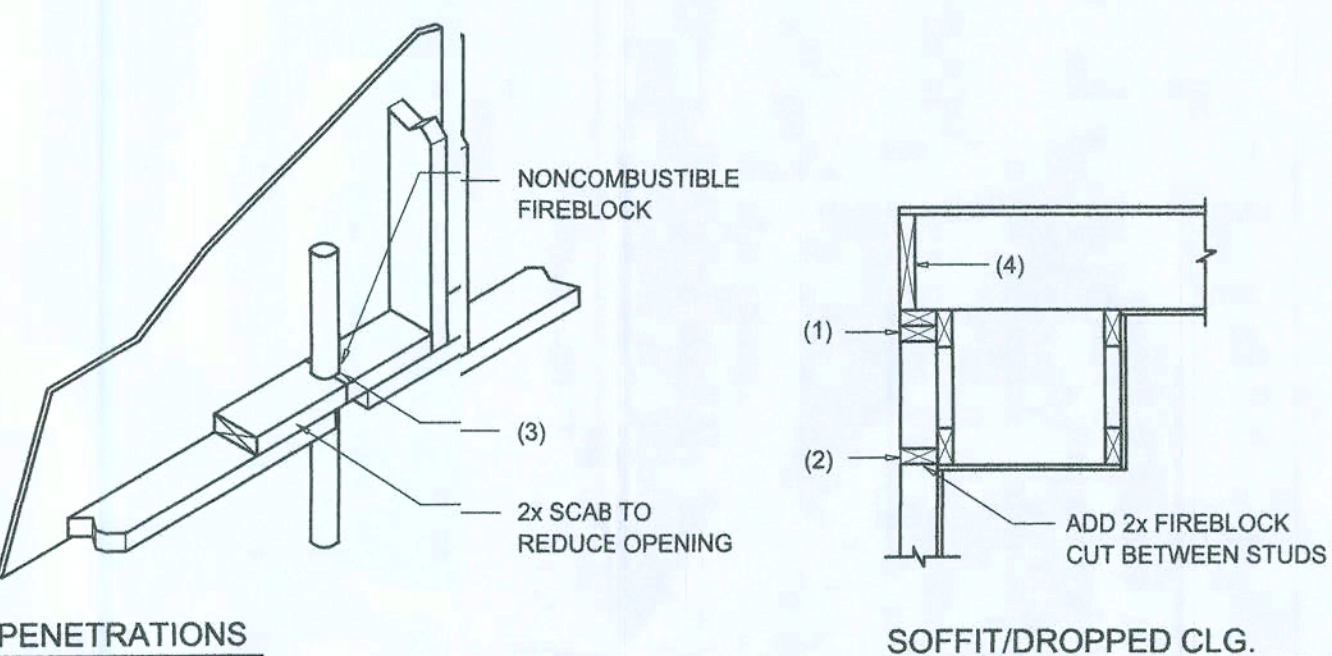

FIREBLOCKING NOTES:

- FIREBLOCKING SHALL BE INSTALLED IN WOOD FRAME CONSTRUCTION IN THE FOLLOWING LOCATIONS:
- IN CONCEALED SPACES OF STUD WALLS AND PARTITIONS INCLUDING FURRED SPACES AT CEILING AND FLOOR LEVELS.
 - AT ALL INTERCONNECTIONS BETWEEN CONCEALED VERTICAL AND HORIZONTAL SPACES SUCH AS OCCUR AT SOFFITS, DROP CEILINGS, COVE CEILINGS, ETC.
 - AT OPENINGS AROUND VENTS, PIPES, DUCTS, CHIMNEYS AND FIREPLACES AT CEILING AND FLOOR LEVELS WITH "PYRO PANEL MULTIFLEX SEALANT"
 - AT ALL INTERCONNECTIONS BETWEEN CONCEALED VERTICAL STUD WALL OR PARTITION SPACES AND CONCEALED SPACES CREATED BY AN ASSEMBLY OF FLOOR JOISTS, FIREBLOCKING SHALL BE PROVIDED FOR THE FULL DEPTH OF THE JOISTS AT THE ENDS AND OVER THE SUPPORTS.

Fire Stopping DETAILS

SCALE: NONE



General Roofing NOTES:

DECK REQUIREMENTS:
 ASPHALT SHINGLES SHALL BE FASTENED TO SOLIDLY SHEATHED DECKS.

SLOPE:
 ASPHALT SHINGLES SHALL BE USED ONLY ON ROOF SLOPES OF 2:12 OR GREATER. FOR ROOF SLOPES FROM 2:12 TO 4:12, DBL. UNDERLAYMENT IS REQUIRED.

UNDERLAYMENT:
 UNLESS OTHERWISE NOTED, UNDERLAYMENT SHALL CONFORM W/ ASTM D 226, TYPE 1, OR ASTM D 4869, TYPE 1.

SELF-ADHERING POLYMER MODIFIED BITUMEN SHEET:
 SELF ADHERING POLYMER MODIFIED BITUMEN SHALL COMPLY W/ ASTM D 1970.

ASPHALT SHINGLES:
 ASPHALT SHINGLES SHALL HAVE SELF SEAL STRIPS OR BE INTERLOCKING, AND COMPLY WITH ASTM D 225 OR ASTM D 3462.

FASTENERS:
 FASTENERS FOR ASPHALT SHINGLES SHALL BE GALVANIZED, STAINLESS STEEL, ALUMINUM OR COPPER ROOFING NAILS, MINIMUM 12 GAUGE SHANK WITH A MINIMUM 3/8 INCH DIAMETER HEAD, OF A LENGTH TO PENETRATE THROUGH THE ROOFING MATERIAL AND A MINIMUM 3/4" INTO THE ROOF SHEATHING. WHERE THE SHEATHING IS LESS THAN 3/4" THICK, THE NAILS SHALL PENETRATE THROUGH THE SHEATHING.

ATTACHMENT:
 ASPHALT SHINGLES SHALL BE SECURED TO THE ROOF WITH NOT LESS THAN FOUR FASTENERS PER STRIP SINGLE OR TWO FASTENERS PER INDIVIDUAL SHINGLE. WHERE ROOFS LOCATED IN BASIC WIND SPEED OF 110 MPH OR GREATER, SPECIAL METHODS OF FASTENING ARE REQUIRED. UNLESS OTHERWISE NOTED, ATTACHMENT OF ASPHALT SHINGLES SHALL CONFORM WITH ASTM D 3161 OR MDC PA 107-95.

UNDERLAYMENT APPLICATION:
 FOR ROOF SLOPES FORM 2:12 TO 4:12, UNDERLAYMENT SHALL BE A MINIMUM OF TWO LAYERS APPLIED AS FOLLOWS:

- STARTING AT THE EAVE, A 19 INCH STRIP OF UNDERLAYMENT SHALL BE APPLIED PARALLEL WITH THE EAVE AND FASTENED SUFFICIENTLY TO STAY IN PLACE.
- STARTING AT THE EAVE, 36 INCH WIDE STRIPS OF UNDERLAYMENT FELT SHALL BE APPLIED OVERLAPPING SUCCESSIVE SHEETS 19 INCHES AND FASTENED SUFFICIENTLY TO STAY IN PLACE.

FOR ROOF SLOPED 4:12 AND GREATER, UNDERLAYMENT SHALL BE A MINIMUM OF ONE LAYER OF UNDERLAYMENT FELT APPLIED AS FOLLOWS:
 STARTING AT THE EAVE, UNDERLAYMENT SHALL BE APPLIED SINGLE FASHION PARALLEL TO THE EAVE, LAPPED 2 INCHES, AND FASTENED SUFFICIENTLY TO STAY IN PLACE.

BASE AND CAP FLASHINGS:
 BASE AND CAP FLASHING SHALL BE INSTALLED IN ACCORDANCE W/ MFG'S INSTALLATION INSTRUCTIONS. BASE FLASHING SHALL BE OF EITHER CORROSION RESISTANT METAL OF MINIMUM NOMINAL THICKNESS 0.019 INCH OR MINERAL SURFACE ROLL ROOFING WEIGHING A MINIMUM OF 77 LBS PER 100 SQUARE FEET. CAP FLASHING SHALL BE CORROSION RESISTANT METAL OF MINIMUM NOMINAL THICKNESS OF 0.019 INCH.

VALLEYS:
 VALLEY LININGS SHALL BE INSTALLED IN ACCORDANCE W/ MANUFACTURER'S INSTALLATION INSTRUCTIONS BEFORE APPLYING ASPHALT SHINGLES. VALLEY LININGS OF THE FOLLOWING TYPES SHALL BE PERMITTED.

- FOR OPEN VALLEYS LINED WITH METAL, THE VALLEY LINING SHALL BE AT LEAST 16" WIDE AND OF ANY OF THE CORROSION RESISTANT METALS IN FBC TABLE 1507.3.9.2.
- FOR OPEN VALLEYS, VALLEY LINING OF TWO PLYS OF MINERAL SURFACE ROLL ROOFING SHALL BE PERMITTED. THE BOTTOM LAYER SHALL BE 18 INCHES AND THE TOP LAYER A MINIMUM OF 36 INCHES WIDE.
- FOR CLOSED VALLEYS VALLEY LINING SHALL BE ONE OF THE FOLLOWING:
 - BOTH TYPES 1 AND 2 ABOVE, COMBINED.
 - ONE PLY OF SMOOTH ROLL ROOFING AT LEAST 36 INCHES WIDE AND COMPLYING WITH ASTM D 224.
 - SPECIALTY UNDERLAYMENT AT LEAST 36 INCHES WIDE AND COMPLYING WITH ASTM D 1970.

NOTE !!!
 ROOF SHINGLES SHALL BE AS MANUFACTURED BY "TAMKO ROOFING PRODUCTS" OF THE FOLLOWING MODELS:

- GLASS-SEAL AR
- ELITE GLASS-SEAL AR
- HERITAGE 30 AR
- HERITAGE 40 AR
- HERITAGE 50 AR

THESE SHINGLES MEET THE REQUIREMENTS OF ASTM D-3161 TYPE 1 MODIFIED TO 110 MPH WINDS & FBC TAS 100, USING 4 NAILS/SHINGLE

REVISIONS	January 08, 2009

SOFTPLAN
 ARCHITECTURAL DESIGN SOFTWARE

DETAILS SHEET

A RENTAL HOME FOR:

ANDREW SCHEIDER

PROJECT ADDRESS: SW COATS GLEN, COLUMBIA COUNTY, FLORIDA

AR0007005

NS

NICHOLAS J. BEISLER
 ARCHITECT
 A.C.A.R.B. Certified

1788 NW Brown Rd.
 Ft. Lauderdale, FL 33305
 (954) 755-9021

JOB NUMBER
 090101

SHEET NUMBER
S.3
 OF 4 SHEETS

NOTE: ALL DRAWINGS NOT TO BE SCALED, WRITTEN DIMENSIONS TAKE PRECEDENCE OVER SCALED DIMENSIONS

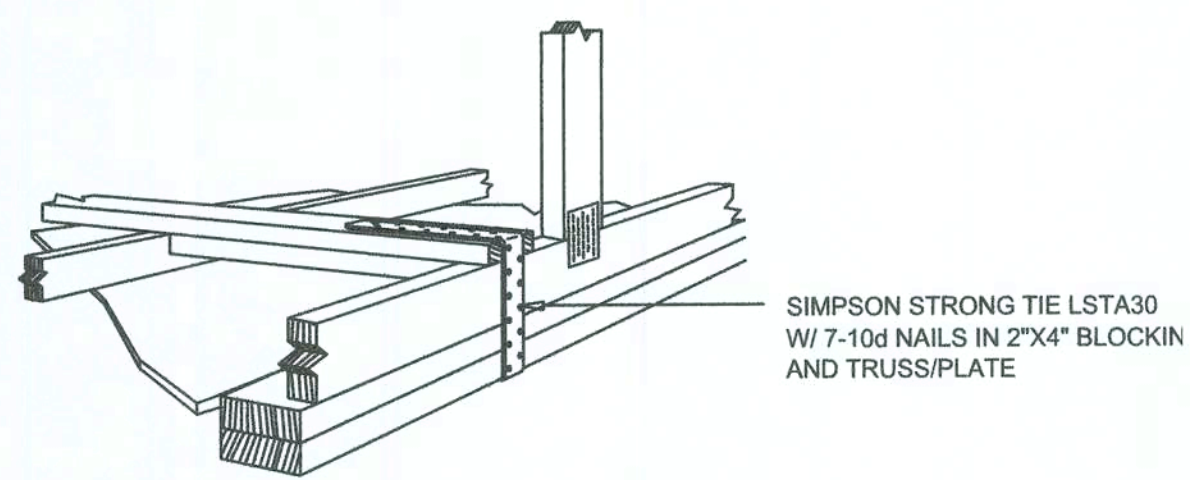

GABLE END GYPSUM DIAPHRAGM HOLDDOWN CONNECTOR

SCALE: NONE

A.1

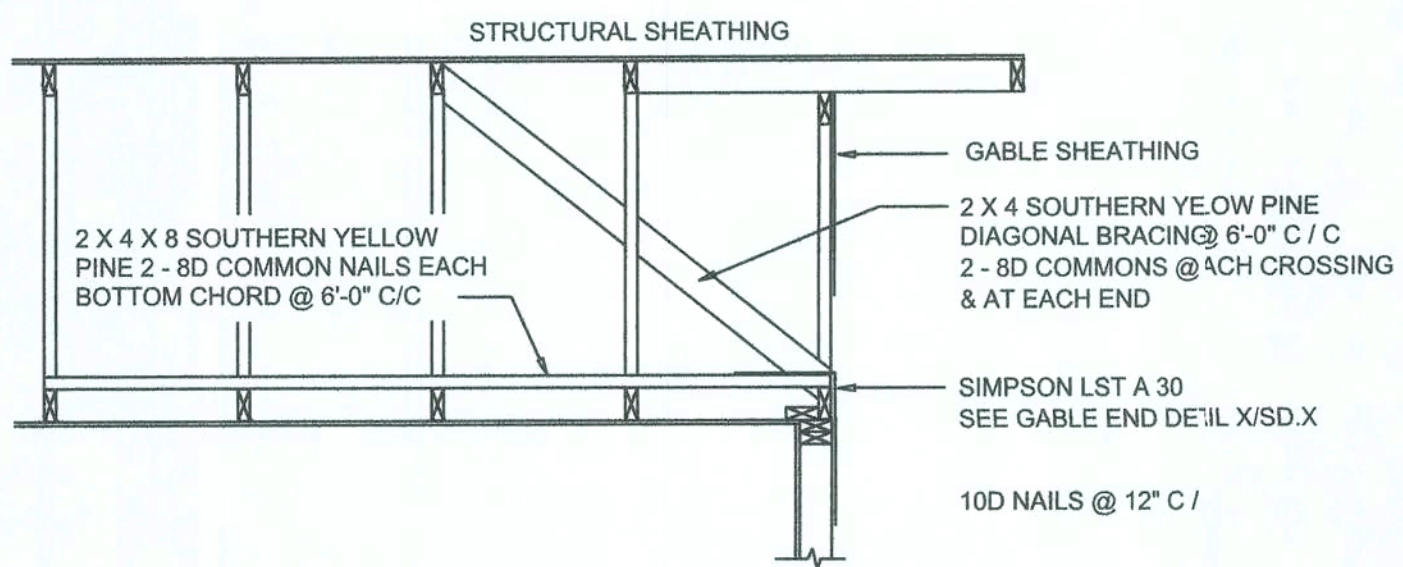

END WALL BRACING FOR CEILING DIAPHRAGM

NTS (ALTERNATIVE TO BALLOON FRAMING)

NOTE: ALL WOOD TO BE NUMBER 2 GRADE SOUTHERN YELLOW PINE

A

ROOF SHEATHING FASTENINGS			
NAILING ZONE	SHEATHING TYPE	FASTENER	SPACING
1			6 in. o.c. EDGE 12 in. o.c. FIELD
2	7/16" O.S.B. OR 15/32 CDX	8d COMMON OR 8d HOT DIPPED GALVANIZED BOX NAILS	6 in. o.c. EDGE 6 in. o.c. FIELD
3			4 in. o.c. @ GABLE ENDWALL OR GABLE TRUSS 6 in. o.c. EDGE 6 in. o.c. FIELD

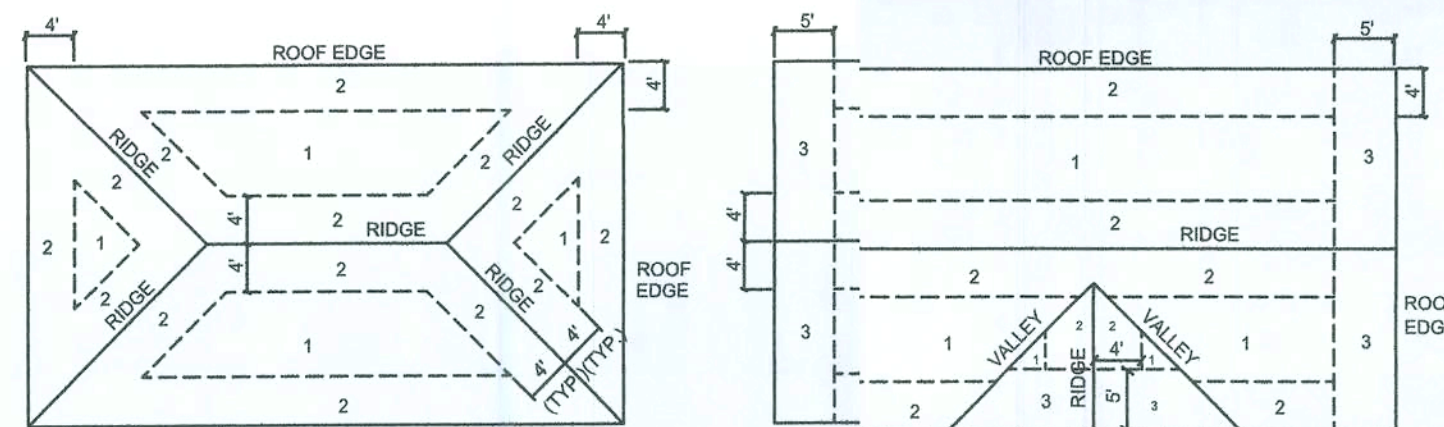

ROOF SHEATHING NAILING ZONES (HIP ROOF)

ROOF SHEATHING NAILING ZONES (GABLE ROOF)

Roof Nail Pattern DET.

SCALE: NONE

B

HEADER SPANS FOR EXTERIOR BEARING WALLS							
HEADERS SUPPORTING:	HEADER SIZE	BUILDING WIDTH (FT)					
		20'		28'		36'	
		SPAN	# JACKS	SPAN	# JACKS	SPAN # JACKS	
ROOF, CEILING	2-2x4	3'-6"	1	3'-2"	1	2'-10"	1
	2-2x6	5'-5"	1	4'-8"	1	4'-2"	1
	2-2x8	6'-10"	1	5'-11"	2	5'-4"	1
	2-2x10	8'-5"	2	7'-3"	2	6'-6"	2
	2-2x12	9'-9"	2	8'-5"	2	7'-6"	2
	3-2x8	8'-4"	1	7'-5"	1	6'-8"	1
	3-2x10	10'-6"	1	9'-1"	2	8'-2"	1
	3-2x12	12'-2"	2	10'-7"	2	9'-5"	2
	4-2x8	9'-2"	1	8'-4"	1	9'-2"	1
	4-2x10	11'-8"	1	10'-6"	1	9'-5"	1
	4-2x12	14'-1"	1	12'-2"	2	10'-11"	1

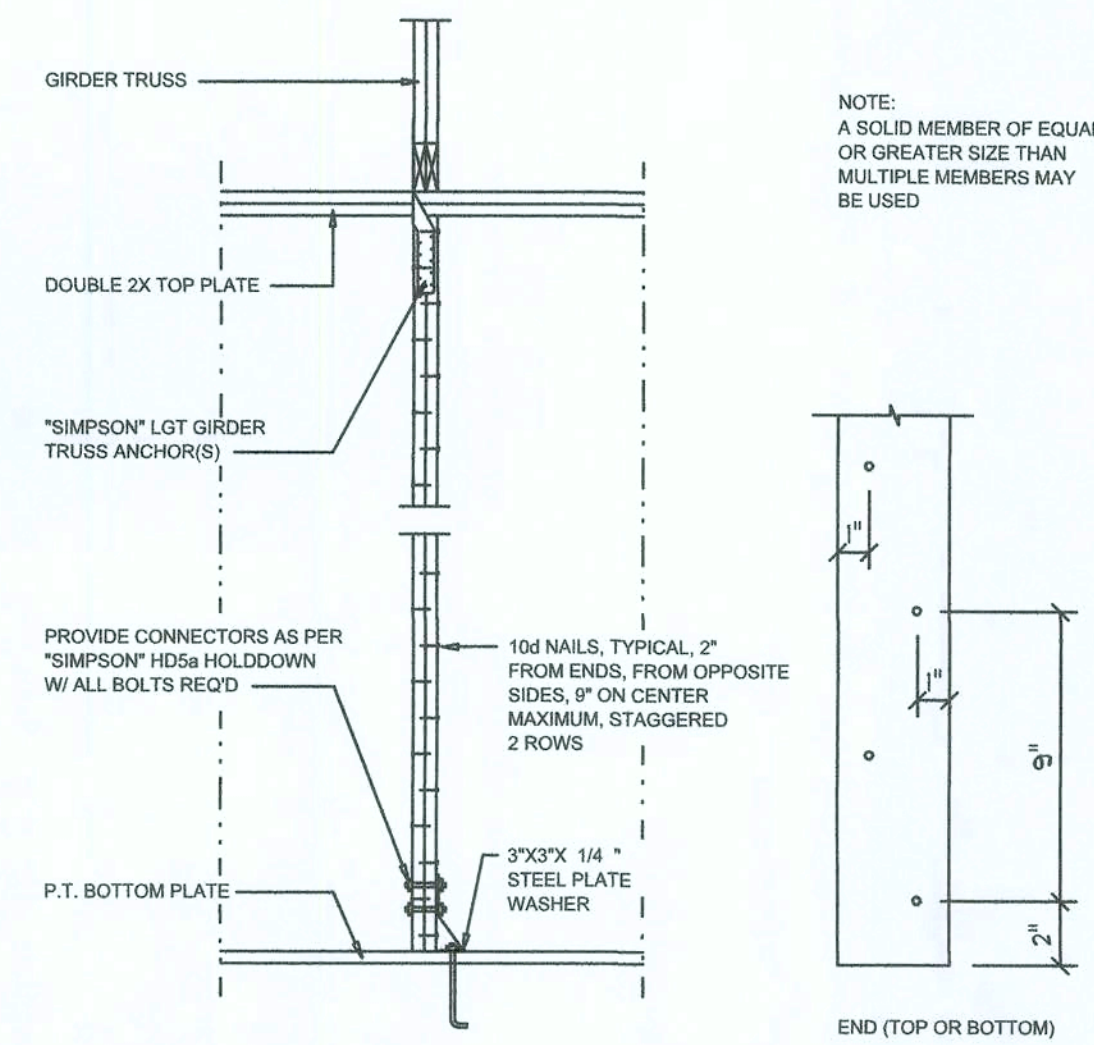

Girdler Truss Column DET.

SCALE: 1/2" = 1'-0"

C

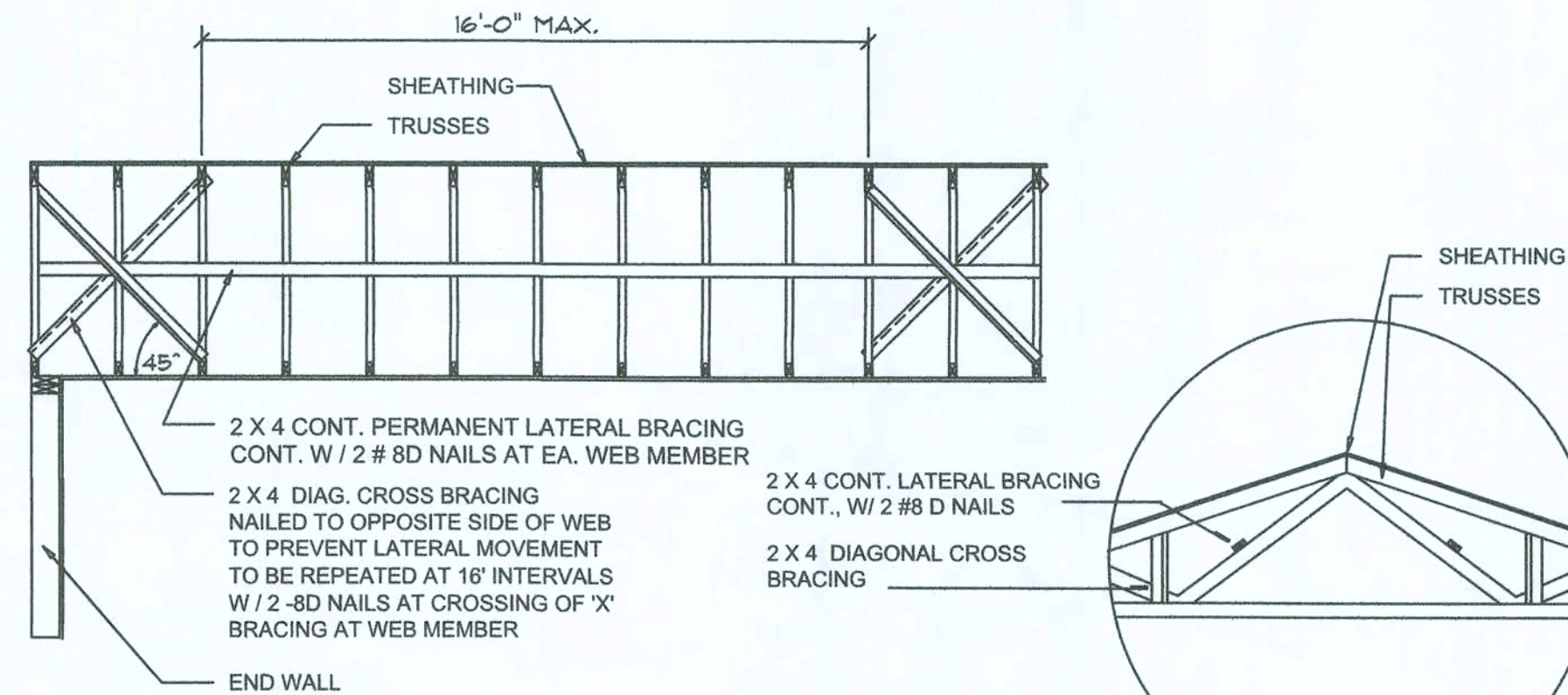

TYP. PERMANENT TRUSS BRACING DIA.

NTS
NOTE: ALL WOOD TO BE NUMBER 2 GRADE SOUTHERN YELLOW PINE

Truss Bracing DETAILS

SCALE: AS NOTED

D

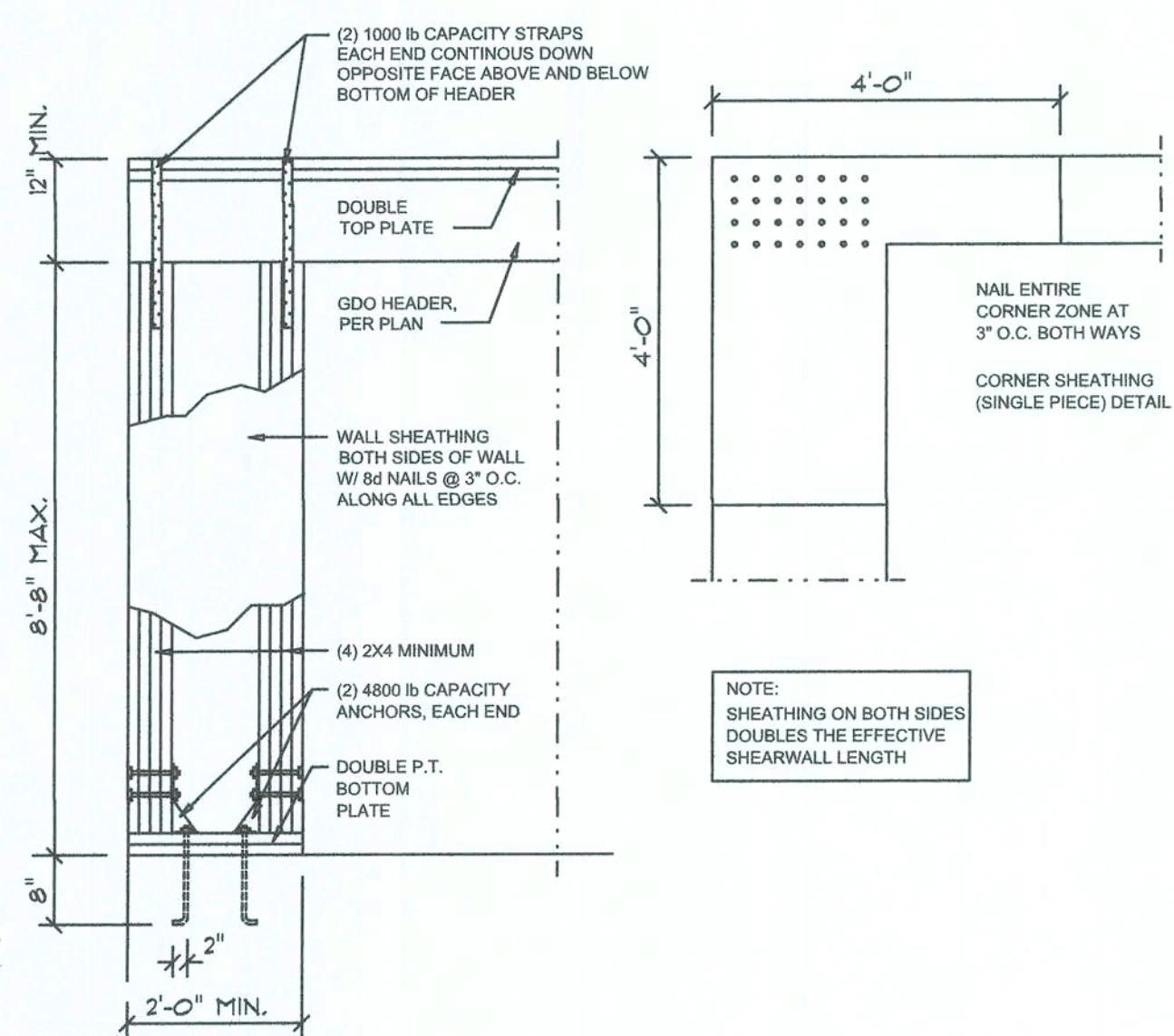

Garage End Wall DETAILS

SCALE: 1/2" = 1'-0"

G

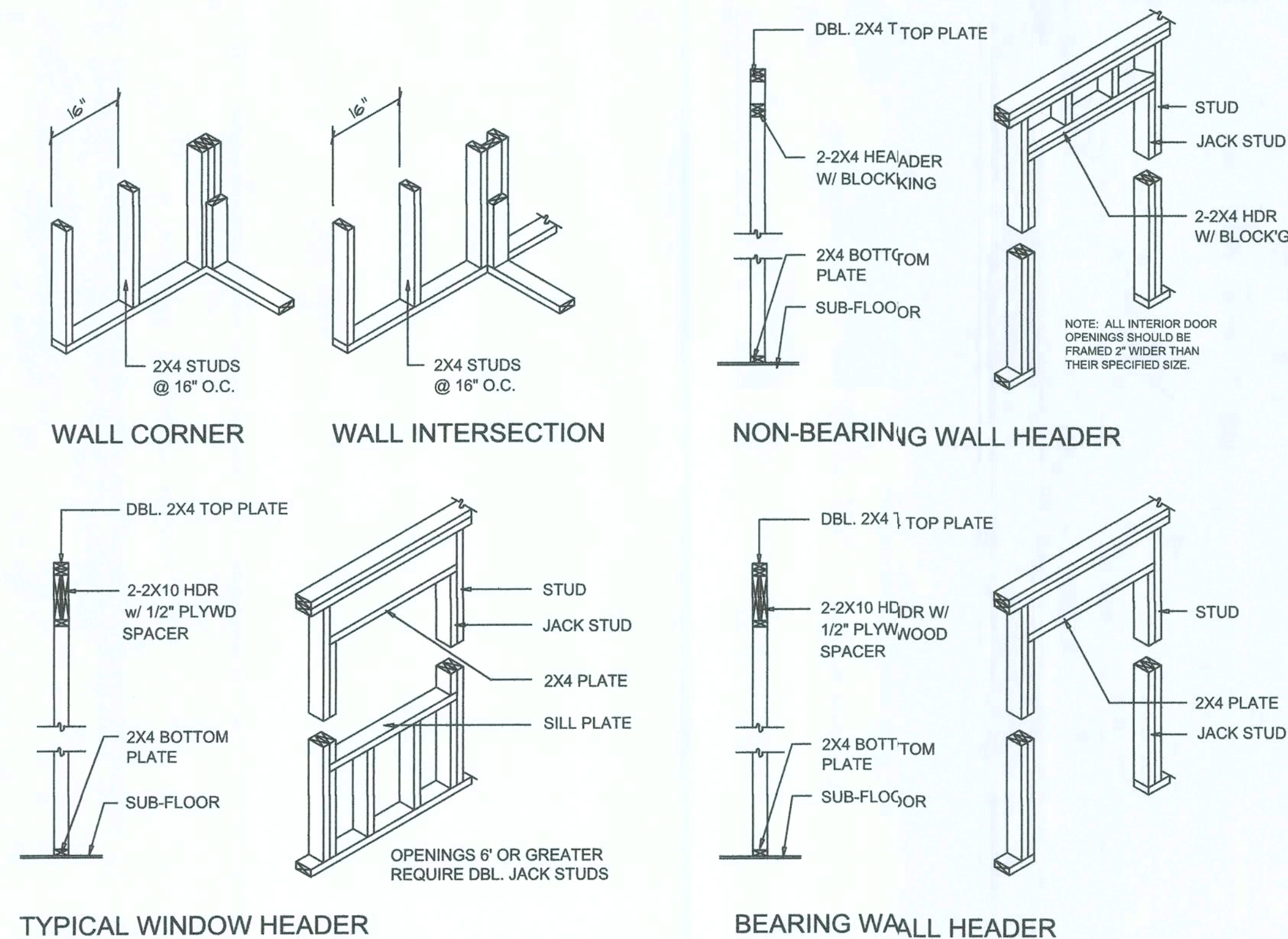

Wall Framing/Header DETAILS

SCALE: NONE

F

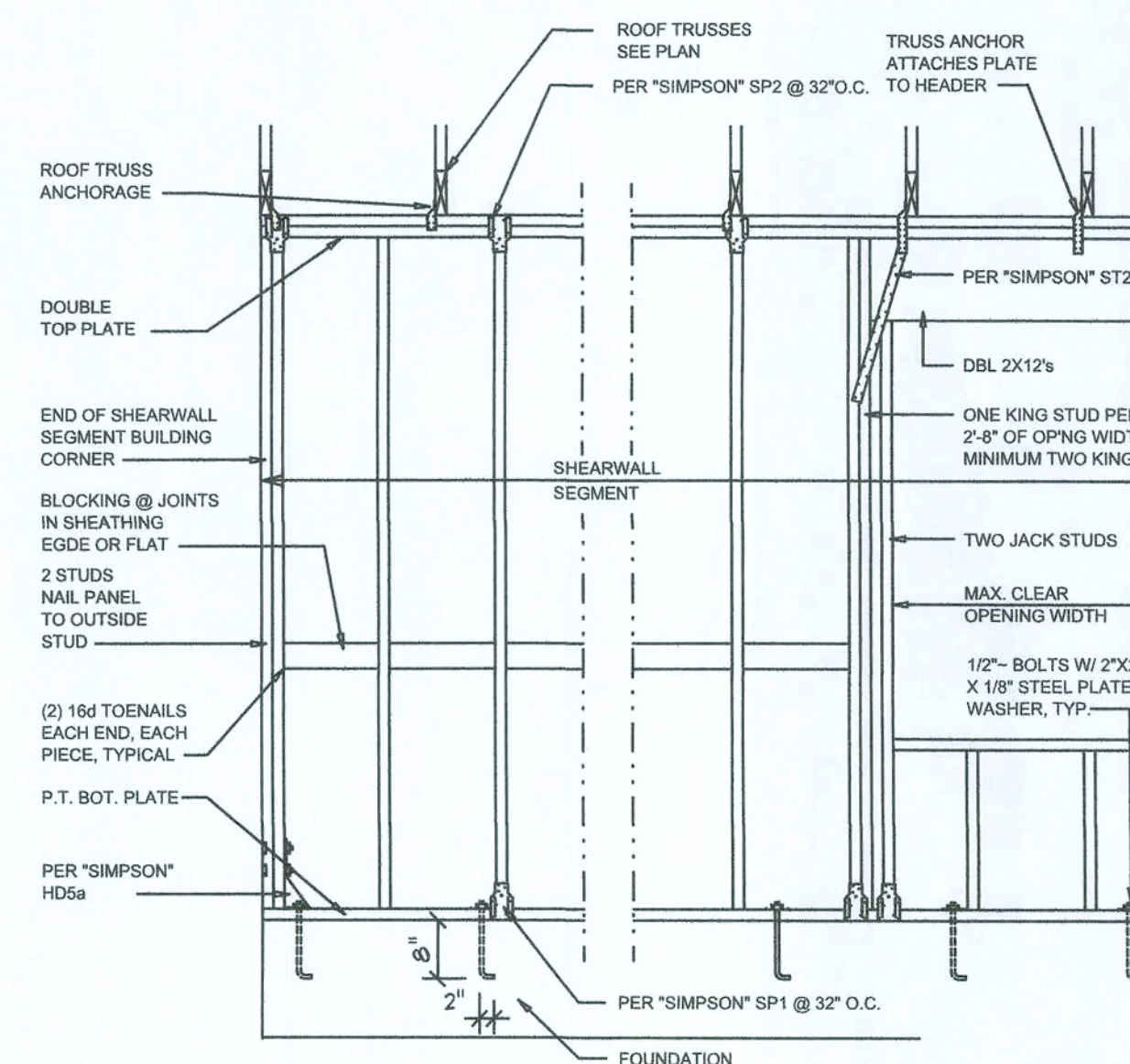

Shear Wall DETAILS

SCALE: NONE

E

- SHEARWALL NOTES:**
- ALL SHEARWALLS SHALL BE TYPE 2 SHEARWALLS AS DEFINED BY STD 10-97 SBC 305.4.3.
 - THE WALL SHALL BE ENTIRELY SHEATHED WITH 7/16" O.S.B. INCLUDING AREAS ABOVE AND BELOW OPENINGS.
 - ALL SHEATHING SHALL BE ATTACHED TO FRAMING ALONG ALL FOUR EDGES WITH JOINTS FOR ADJACENT PANELS OCCURRING OVER COMMON FRAMING MEMBERS OR ALONG BLOCKING.
 - NAIL SPACING SHALL BE 6" O.C. EDGES AND 12" O.C. IN THE FIELD.
 - TYPE 2 SHEARWALLS ARE DESIGNED FOR THE OPENING IT CONTAINS. MAXIMUM HEIGHT OF OPENING SHALL BE 5/8 TIMES THE WALL HEIGHT. THE MINIMUM DISTANCE BETWEEN OPENINGS SHALL BE THE WALL HEIGHT/3.5 FOR 8'-0" WALLS (2'-3").

OPENING WIDTH	SILL PLATES	16d TOE NAILS EACH END
UP TO 6'-0"	(1) 2x4 OR (1) 2x6	1
> 6 TO 9'-0"	(3) 2x4 OR (1) 2x6	2
> 9 TO 12'-0"	(3) 2x4 OR (2) 2x6	3

NOTE: ALL DRAWINGS NOT TO BE SCALED, WRITTEN DIMENSIONS TAKE PRECEDENCE OVER SCALED DIMENSIONS

REVISIONS
January 08, 2009

SOFTWARE
ARCHITECTURAL DESIGN SOFTWARE

DETAILS SHEET
SCALE: 1/2" = 1'-0"

A RENTAL HOME FOR:
ANDREW SCINCLIPER
PROJECT ADDRESS: SW COATS GLEN, COLUMBIA COUNTY, FLORIDA

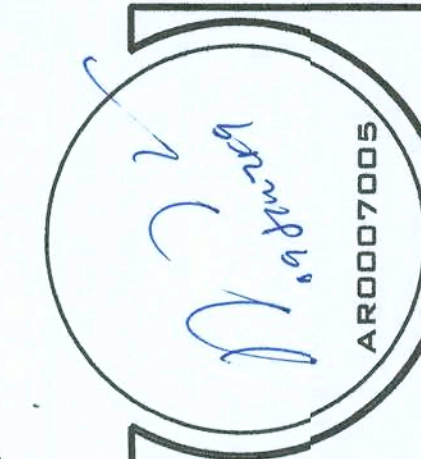

NE
NICHOLAS
GEISLER
ARCHITECT
A.C.A.R.B. Certified
1758 NW Brown Rd.
Gainesville, FL 32605
(352) 755-9027

JOB NUMBER
090101

SHEET NUMBER
S.4
OF 4 SHEETS