

Mobile Home Permit Worksheet

Installer: Brandy Hall License # IH/1126663
 Address of home being installed: 330 SW Seville PL
Lake City, FL 32024
 Manufacturer: LIVE OAK Length x width: 116x76

NOTE: If home is a single wide fill out one half of the blocking plan
 If home is a triple or quad wide sketch in remainder of home
 I understand Lateral Arm Systems cannot be used on any home (new or used)
 where the sidewall ties exceed 5 ft 4 in.

Installer's initials: BH

Application Number: _____ Date: _____

New Home Used Home
 Home installed to the Manufacturer's Installation Manual
 Home is installed in accordance with Rule 15-C
 Single wide Wind Zone II Wind Zone III
 Double wide Installation Decal # 78008
 Triple/Quad Serial # LOHGA20036437

PIER SPACING TABLE FOR USED HOMES

Load bearing capacity	Footer size (sq in)	16" x 16" (256)	18 1/2" x 18 1/2" (342)	20" x 20" (400)	22" x 22" (484)*	24" X 24" (576)*	26" x 26" (676)
1000 psf	3'	3'	4'	5'	6'	7'	8'
1500 psf	4' 6"	4' 6"	6'	7'	8'	8'	8'
2000 psf	6'	6'	8'	8'	8'	8'	8'
2500 psf	7' 6"	7' 6"	8'	8'	8'	8'	8'
3000 psf	8'	8'	8'	8'	8'	8'	8'
3500 psf	8'	8'	8'	8'	8'	8'	8'

* interpolated from Rule 15C-1 pier spacing table.

PIER PAD SIZES

I-beam pier pad size: 24x24
 Perimeter pier pad size: 11
 Other pier pad sizes (required by the mfg.): 11

POPULAR PAD SIZES

Pad Size	Sq In
16 x 16	256
16 x 18	288
18.5 x 18.5	342
16 x 22.5	360
17 x 22	374
13 1/4 x 26 1/4	348
20 x 20	400
17 3/16 x 25 3/16	441
17 1/2 x 25 1/2	446
24 x 24	576
26 x 26	676

Draw the approximate locations of marriage wall openings 4 foot or greater. Use this symbol to show the piers.

List all marriage wall openings greater than 4 foot and their pier pad sizes below.

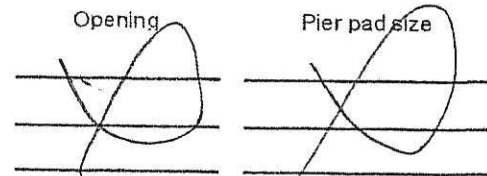

TIEDOWN COMPONENTS

Longitudinal Stabilizing Device (LSD)
 Manufacturer: XLS systems
 Longitudinal Stabilizing Device w/ Lateral Arms
 Manufacturer: XLS systems

ANCHORS

4 ft _____ 5 ft
 FRAME TIES
 within 2' of end of home spaced at 5' 4" oc

OTHER TIES

Number
 Sidewall _____
 Longitudinal ✓ **3**
 Marriage wall _____
 Shearwall ✓

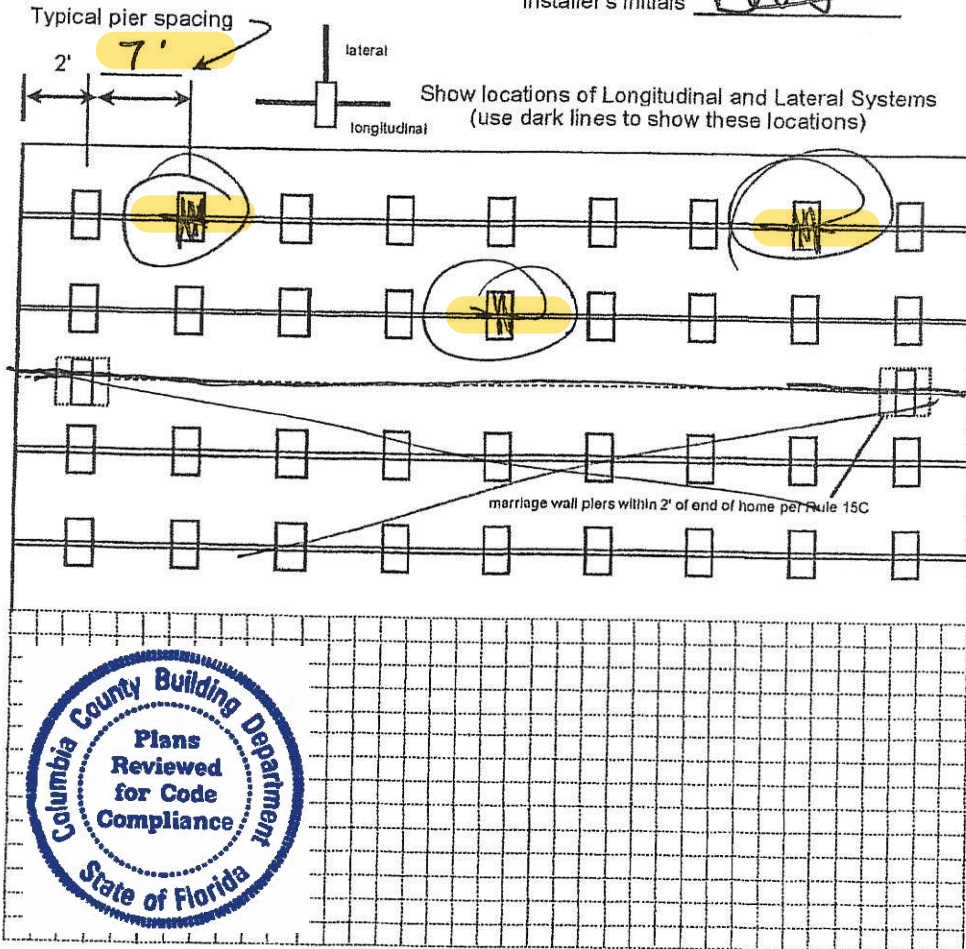

Anthony Islam 05/07/2021

Mobile Home Permit Worksheet

Application Number: _____ Date: _____

POCKET PENETROMETER TEST

The pocket penetrometer tests are rounded down to _____ psf or check here to declare 1000 lb. soil without testing.

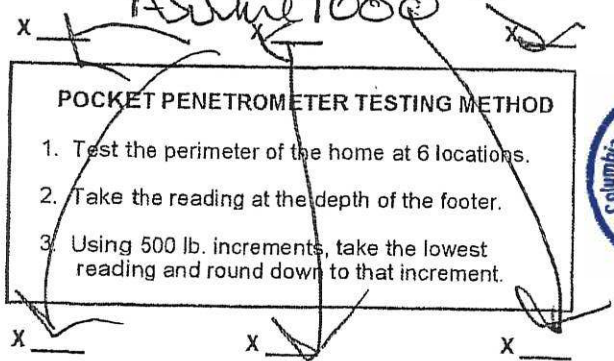

POCKET PENETROMETER TESTING METHOD

1. Test the perimeter of the home at 6 locations.
2. Take the reading at the depth of the footer.
3. Using 500 lb. increments, take the lowest reading and round down to that increment.



X _____ X _____ X _____

TORQUE PROBE TEST

The results of the torque probe test is _____ inch pounds or check here if you are declaring 5' anchors without testing _____. A test showing 275 inch pounds or less will require 5 foot anchors.

Note: A state approved lateral arm system is being used and 4 ft. anchors are allowed at the sidewall locations. I understand 5 ft anchors are required at all centerline tie points where the torque test reading is 275 or less and where the mobile home manufacturer may require anchors with 4000 lb. holding capacity.

[Signature] Installer's initials

ALL TESTS MUST BE PERFORMED BY A LICENSED INSTALLER

Installer Name Brandy Hall
Date Tested 5/4/2021

Electrical

Connect electrical conductors between multi-wide units, but not to the main power source. This includes the bonding wire between multi-wide units. Pg. 105

Plumbing

Connect all sewer drains to an existing sewer tap or septic tank. Pg. 109

Connect all potable water supply piping to an existing water meter, water tap, or other independent water supply systems. Pg. 109

Site Preparation

Debris and organic material removed
Water drainage: Natural _____ Swale _____ Pad Other _____

Fastening multi wide units

Floor: Type Fastener: N/A Length: N/A Spacing: _____
Walls: Type Fastener: N/A Length: N/A Spacing: _____
Roof: Type Fastener: N/A Length: N/A Spacing: _____
For used homes a min. 30 gauge, 8" wide, galvanized metal strip will be centered over the peak of the roof and fastened with galv. roofing nails at 2" on center on both sides of the centerline.

Gasket (weatherproofing requirement)

I understand a properly installed gasket is a requirement of all new and used homes and that condensation, mold, mildew and buckled marriage walls are a result of a poorly installed or no gasket being installed. I understand a strip of tape will not serve as a gasket.

Installer's initials [Signature]

Type gasket N/A Installed: _____
Pg. _____ Between Floors Yes _____
Between Walls Yes _____
Bottom of ridgebeam Yes _____

Weatherproofing

The bottomboard will be repaired and/or taped. Yes _____ Pg. _____
Siding on units is installed to manufacturer's specifications. Yes _____
Fireplace chimney installed so as not to allow intrusion of rain water. Yes _____

Miscellaneous

Skirting to be installed. Yes No _____
Dryer vent installed outside of skirting. Yes N/A _____
Range downflow vent installed outside of skirting. Yes N/A _____
Drain lines supported at 4 foot intervals. Yes _____
Electrical crossovers protected. Yes _____
Other: _____

Installer verifies all information given with this permit worksheet is accurate and true based on the manufacturer's installation instructions and or Rule 15C-1 & 2

Installer Signature [Signature] Date 5/4/21

TROY

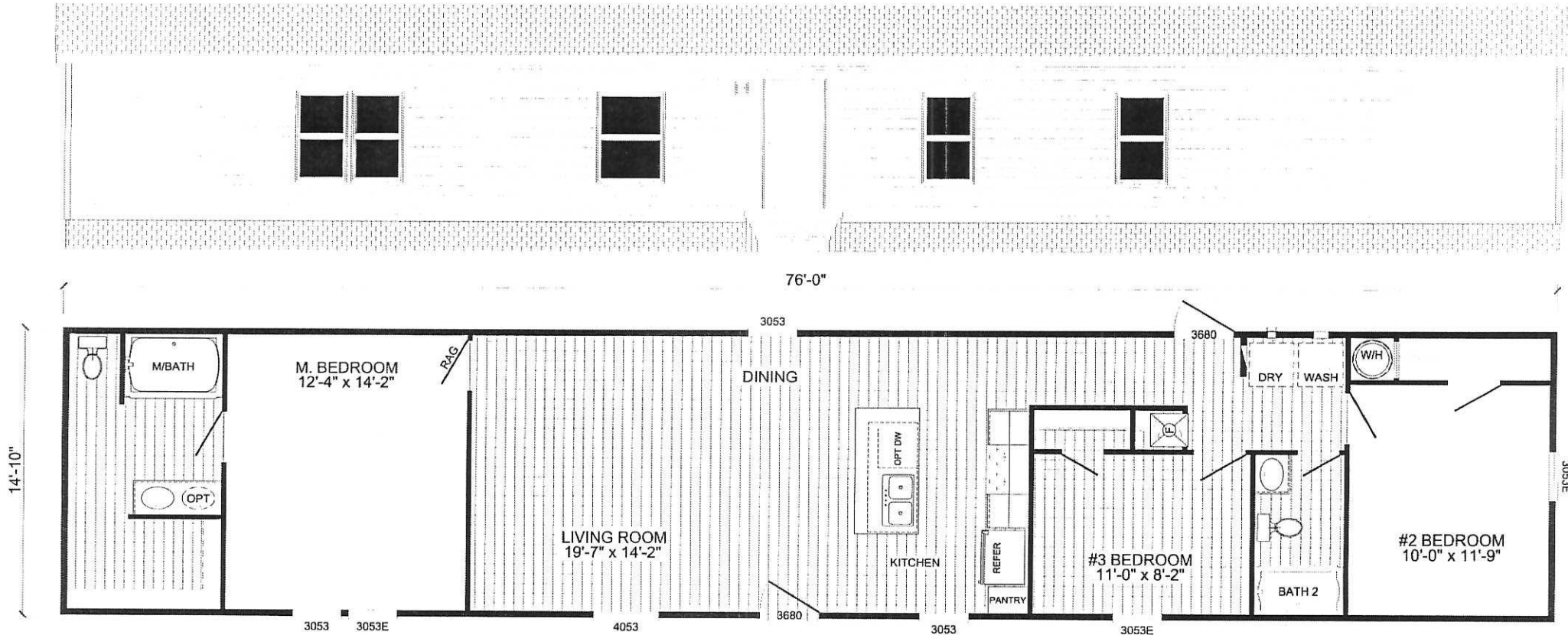

V-5763P - SUWANNEE VALLEY
3-BEDROOM / 2-BATH
16 X 80 - Approx. 1127 Sq. Ft.

Date: 04/30/20

- * All room dimensions include closets and square footage figures are approximate.
- * Transom windows are available on optional 9'-0" sidewall houses only.

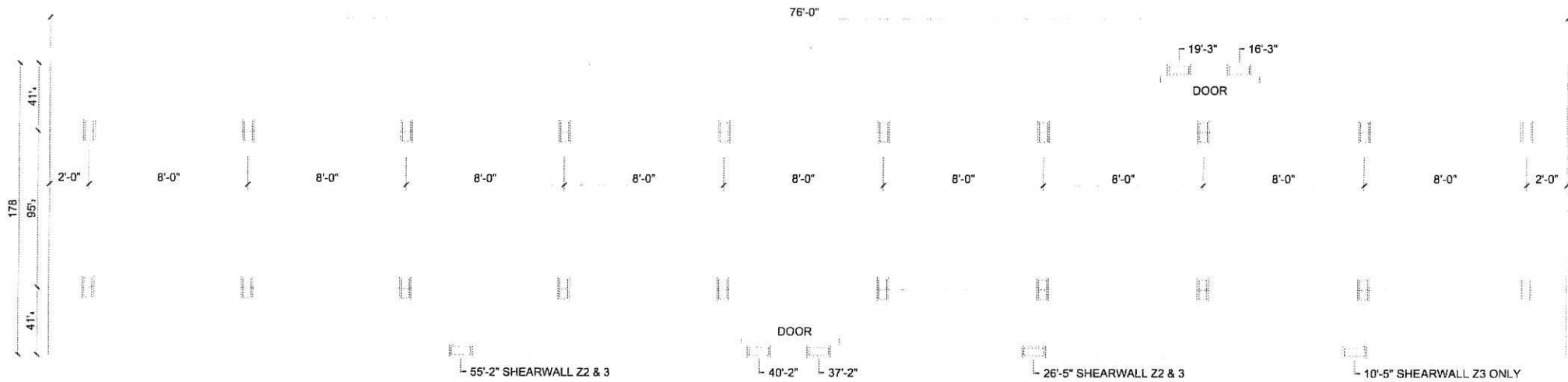

2.3 SUPPORT PIER/TYP

FOUNDATION NOTES:

- THIS DRAWING IS DESIGNED FOR THE STANDARD WIND ZONE AND IS TO BE USED IN CONJUNCTION WITH THE INSTALLATION MANUAL AND ITS SUPPLEMENTS.
- FOOTINGS ARE SHOWN FOR EXAMPLE ONLY QUANTITY AND SPACING MAY VARY BASED ON PAD TYPE, SOIL CONDITION, ETC.
- FOOTINGS ARE REQUIRED AT SUPPORT POSTS, SEE INSTALLATION MANUAL FOR REQUIREMENTS.

Live Oak Homes
MODEL: V-5763P - 16 X 80
3-BEDROOM / 2-BATH



V-5763P

License Number: IH / 1126663 / 1 Name: BRANDY HALL

Order #: 4787	Label #: 78008	Manufacturer:	(Check Size of Home)
Homeowner:		Year Model:	Single _____
Address:		Length & Width:	Double _____
City/State/Zip:		Type Longitudinal System:	Triple _____
Phone #:		Type Lateral Arm System:	HUD Label #:
Date Installed:		New Home: _____ Used Home: _____	Soil Bearing / PSF:
Installed Wind Zone:		Data Plate Wind Zone:	Torque Probe / in-lbs:
Note:			Permit #:

STATE OF FLORIDA
INSTALLATION CERTIFICATION LABEL

78008

LABEL #

DATE OF INSTALLATION

BRANDY HALL

NAME

IH / 1126663 / 1

4787

LICENSE #

ORDER #

CERTIFIES THAT THE INSTALLATION OF THIS MOBILE HOME IS
IN ACCORDANCE WITH FLORIDA STATUTES 320.8249, 320.8325
AND RULES OF THE HIGHWAY SAFETY AND MOTOR VEHICLES.

INSTRUCTIONS

PLEASE WRITE DATE OF
INSTALLATION AND AFFIX
LABEL NEXT TO HUD LABEL.
USE PERMANENT INK PEN
OR MARKER ONLY.
COMPLETE INFORMATION
ABOVE AND KEEP ON FILE
FOR A MINIMUM OF 2 YEARS.
YOU ARE REQUIRED TO
PROVIDE COPIES WHEN
REQUESTED.



**Xi-Steel Pier System
Installation Instructions
By Tie Down Engineering**

Effective: August, 2007
FLORIDA ONLY

Installation instructions for longitudinal and lateral stabilization of manufactured homes set to specifications of the State of Florida.

- Easy installation
- 3 square foot pad and Xi-system replace standard support pier and base pad
- Screw type pier adjusters... no need to use installation jacks to adjust home to system

Steel Pier Systems P/N's

- #59321 Xi, 12" Pier
- #59314 Xi, 25.5" Pier
- #59317 Xi, 36" Pier
- #59315 Xi, 5' Lateral Strut
- #59318 Xi, 5' Lateral Strut

Block Pier Systems P/N's

- #59319 Xi, Lateral w/5' Strut
- #59320 Xi, Lateral w/6' Strut

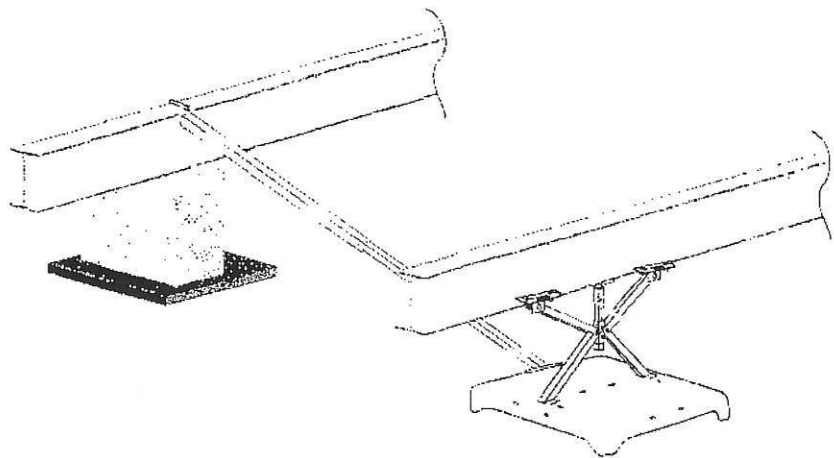

REQUIREMENTS

- Installation can be made in any type of soil, 4B or better
- Florida requires 5' 4" anchor spacing for vertical ties
- 4' ground anchors are used with the Xi-system in 4A and 4B soils, except at shear wall or marriage wall locations where loads exceed 3150 pounds. Florida requires that 5' anchors be used at these locations.
- Center line or shear wall anchors, that may be required by specific manufacturers, are to be sized according to soil torque conditions. Follow all manufacturers instructions for anchor type and placement in addition to Florida regulations.
- Maximum sidewall height is a 96" projection. Higher walls may be used, when the design loads are adjusted accordingly.
- Maximum roof eave is 16"
- Main rail spacing must be 99.5" or less
- Maximum pier height of the Xi-system is 48"
- Instructions are not for use on "Exposure D" homes within 1500 feet of the coastline
- Installation instructions are based on 4200# per pad longitudinal load and 6000# per pad lateral load with one diagonal tie/stabilizer.
- Additional vertical anchor ties that are unique to a home's design may be required by the home manufacturer. These locations include shear walls, marriage line ridge beam support posts, and rim plates.

P/N 15386

TIE DOWN ENGINEERING • 5901 Wheaton Drive • Atlanta GA, 30336
www.tiedown.com • (404) 344-0000 • FAX (404) 349-0401



072307.0126

Longitudinal Stabilization for Florida

When using longitudinal stabilization only, sidewall perimeter anchors with diagonal ties and stabilizer plates every 5'-4" must be used on the home. Vertical ties are also required on homes supplied with vertical tie connection points (per Florida regulations).

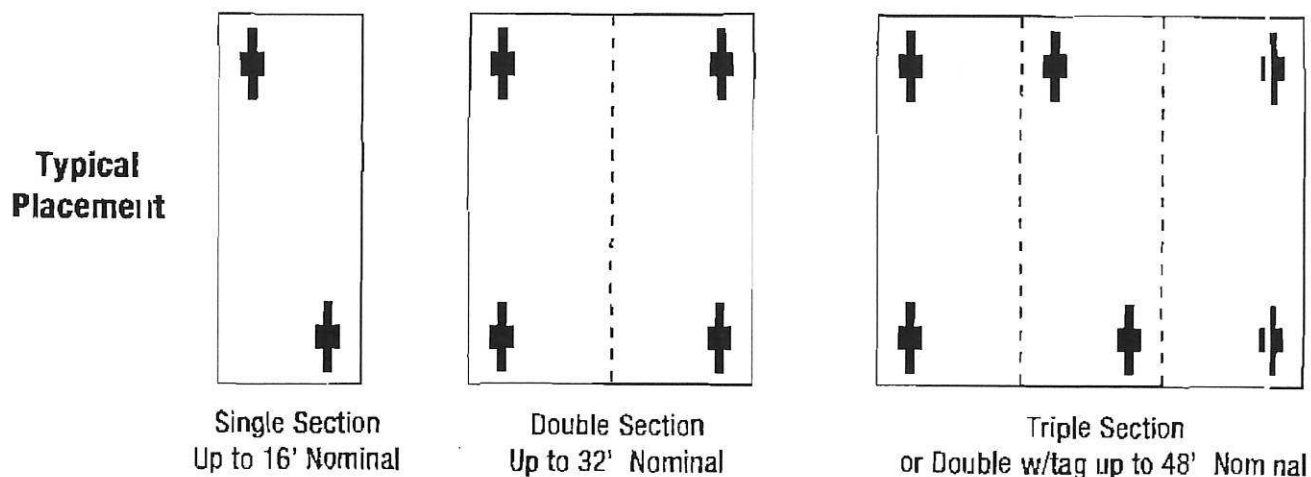

When the Xi-System is used only as longitudinal stabilization, systems must be as evenly spaced as possible, no more than 16' from the end of the home. Maximum roof slope for single units & double section is 5/12, for triple sections is 3.5/12, for the above number of systems.

Combining Longitudinal and Lateral Stabilization for Florida

- Sidewall anchors with vertical ties every 5' 4" per Florida requirements
- Roof slope of 20 degrees or less (See chart for 5/12 roof installations).
- Single and double section homes require the same number of systems
- Triple section homes and double section homes with tag units require two additional longitudinal systems
- Diagram represents single section up to 16' width, double section up to 32' width, and triple section homes up to 48' width.
- NOTE: Older homes without vertical tie attachments, require diagonal frame ties/anchors/plates every 5'-4" per Florida regulations

Xi Block System Assembly

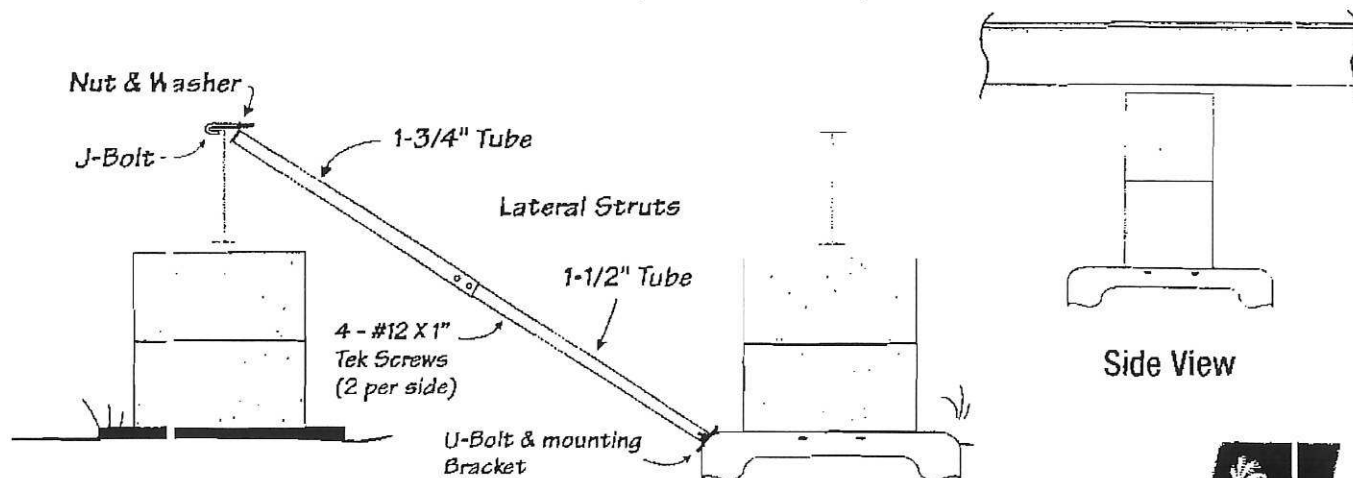

TIE DOWN ENGINEERING • 5901 Wheaton Drive • Atlanta GA, 30336
www.tiedown.com • (404) 344-0000 • FAX (404) 349-0401



072507-0126

Longitudinal and Lateral Stabilization for Florida

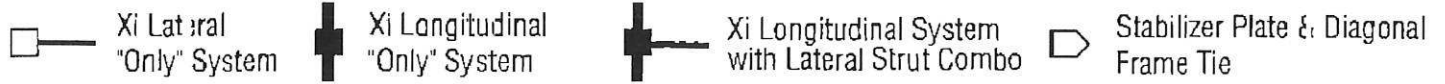

Homes Up To 52'

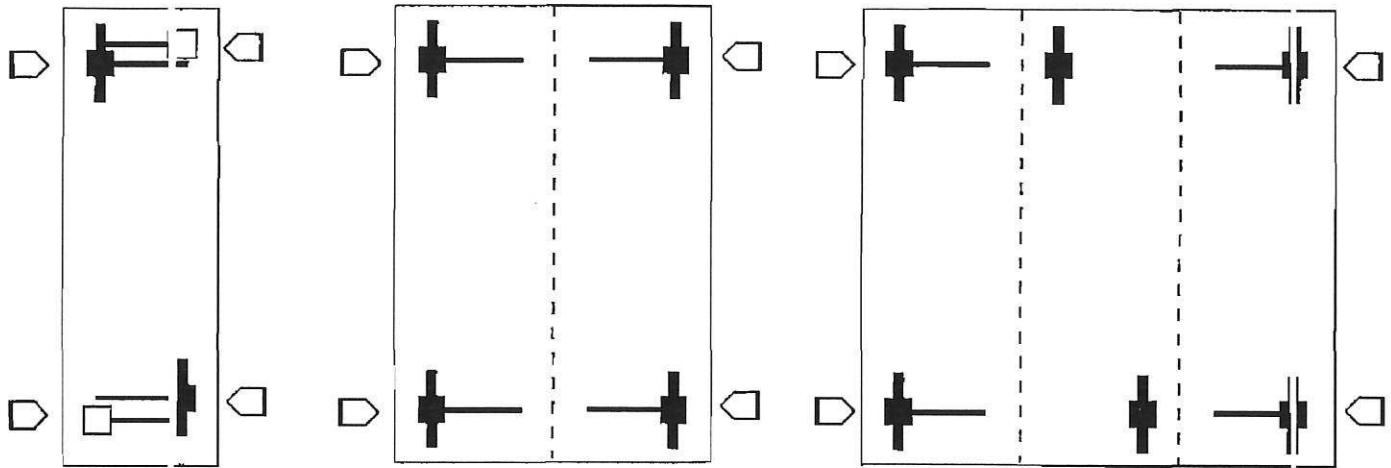

Single
Up to 16' Width
2 Combo Systems
2 Lateral only

Double Section
Up to 32' Width
4 Combo Systems

Triple Section or "Tag"
Up to 48' Width
4 Combo Systems
2 Additional Longitudinal Xi Piers

Homes Over 52', up to 80'

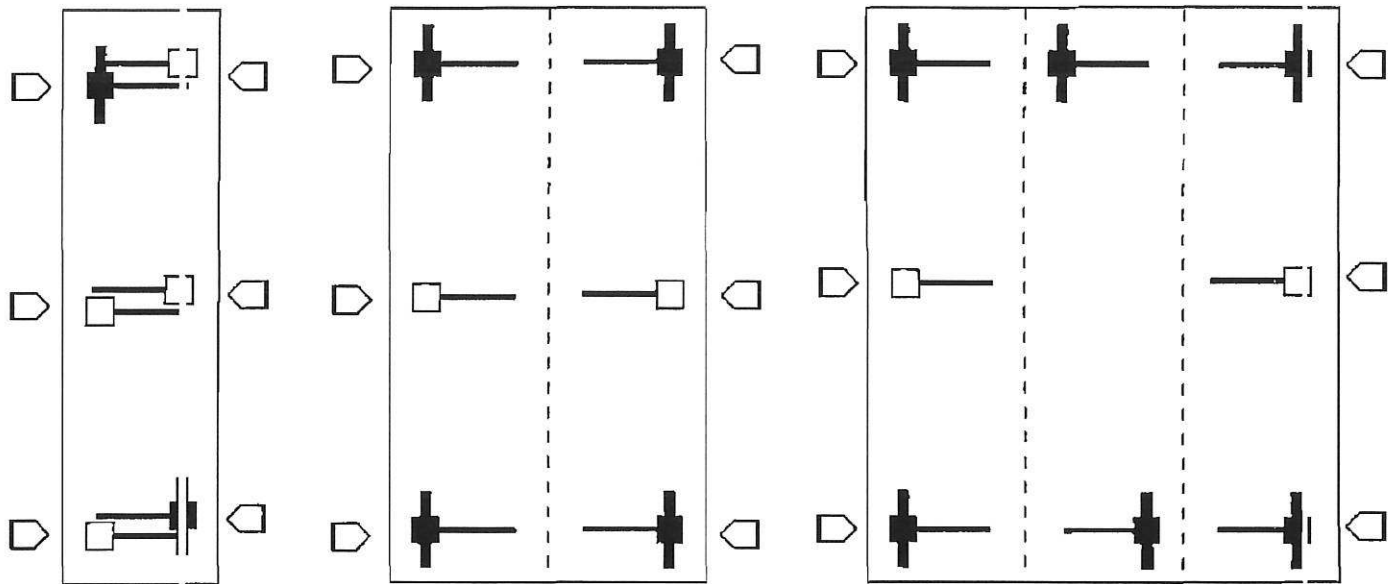

Single:
Up to 16' Width
2 Combo Systems
4 Lateral Only

Double Section
Up to 32' Width
4 Combo Systems/2 Lateral Only

Triple Section or "Tag"
Up to 48' Width
6 Combo Systems/2 Lateral Only

Note: 5/12 roof pitch home requires 2 additional systems.
3 lateral systems up to 52', 8 lateral systems up to 80'

Installation of Longitudinal System (Figure 1)

1. Identify the number of systems to be used on the home using the chart provided.
2. Identify on the location where the longitudinal systems will be installed.
3. Clear all organic matter and debris from the pad site.
4. Place pad centered under beam using the centering mark imprinted on the pad.
5. Press or drive pan into ground until level and flush with prepared surface.
6. Slide Xi-System pier feet into slots in pad so that the Xi-system pier is centered under the I-beam.
7. Raise the escaping extension post to contact the bottom of I-beam, secure with bolt provided, tighten bolt nut. (Figure 1)
8. Turn the nut on pier height adjuster until Xi-System pier is rigid between pad and I-beam.
9. Install Gator Beam clamps to I-beam on each side of the Xi-System pier. Do not tighten nuts at this time. (Figure 2)
10. Connect struts (open side down) to each side of the Xi-System pier using the U-bolt provided. Struts are attached to the upper hole in each pier leg and to the flanges on the beam clamps. (Figure 1)
11. Tighten all nuts and bolts on the struts and beam clamps.

Installation of Lateral System (Figure 3)

1. Assemble lateral strut by sliding smaller (1-1/2") tube into the larger (1-3/4") tube. Holes should be on the sides of the larger tube and the "flag" up on the larger tube.
2. Attach the end of the smaller tube to the inside of the pan using u-bolts and nuts provided.
3. Attach the flag end of the larger tube to the opposite I-beam using the "J" bolt over the top of the I-beam with the nut & washer provided. (Figure 4)
4. Install a minimum of four (1/4"x3/4") self-tapping screws into the holes provided in the lateral strut so that the two tubes are connected together. (Figure 1)

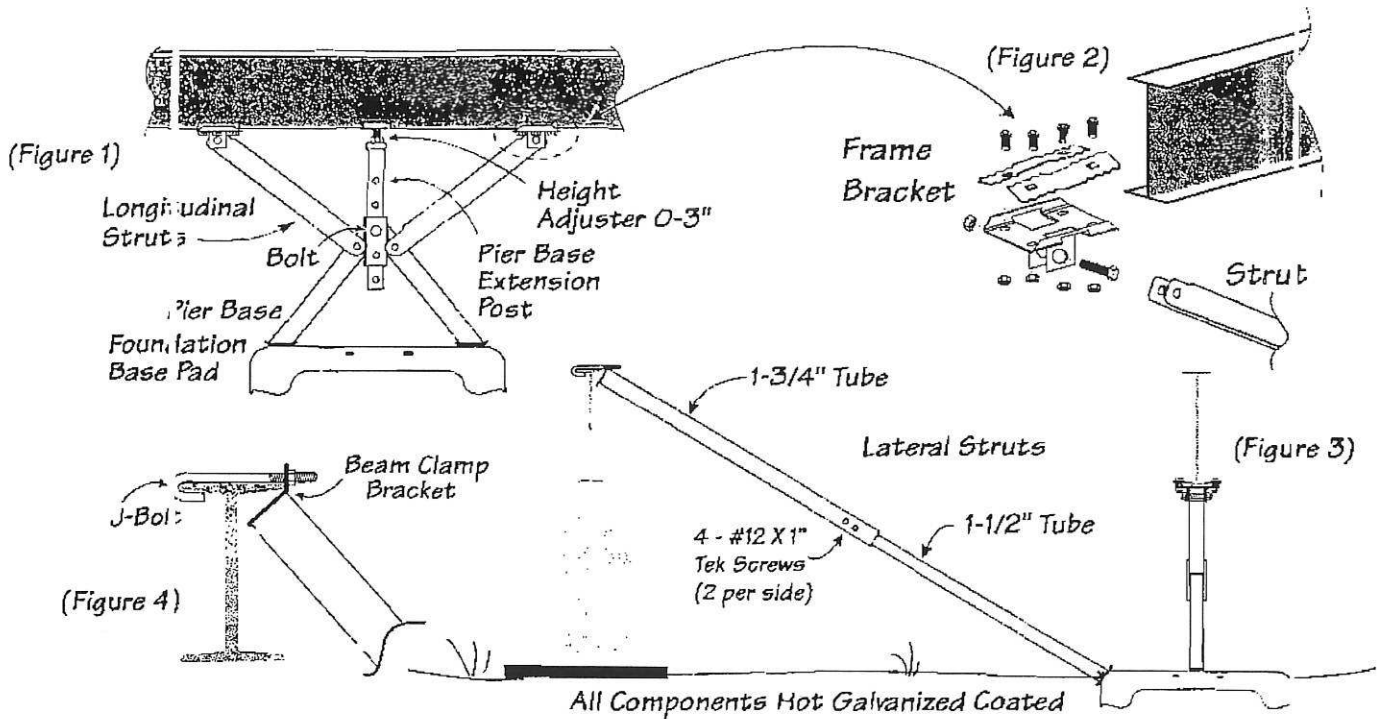

Standard Steps to code

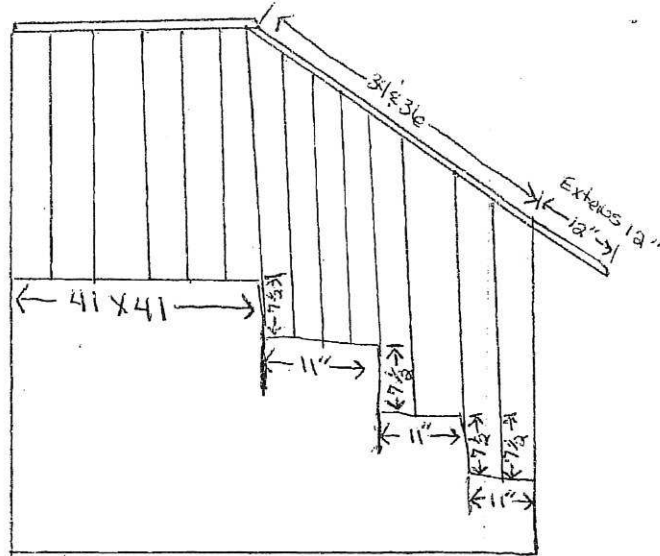

Platform 41 X 41
Spindels 4" on center
treads 11"
risers 7 1/2"

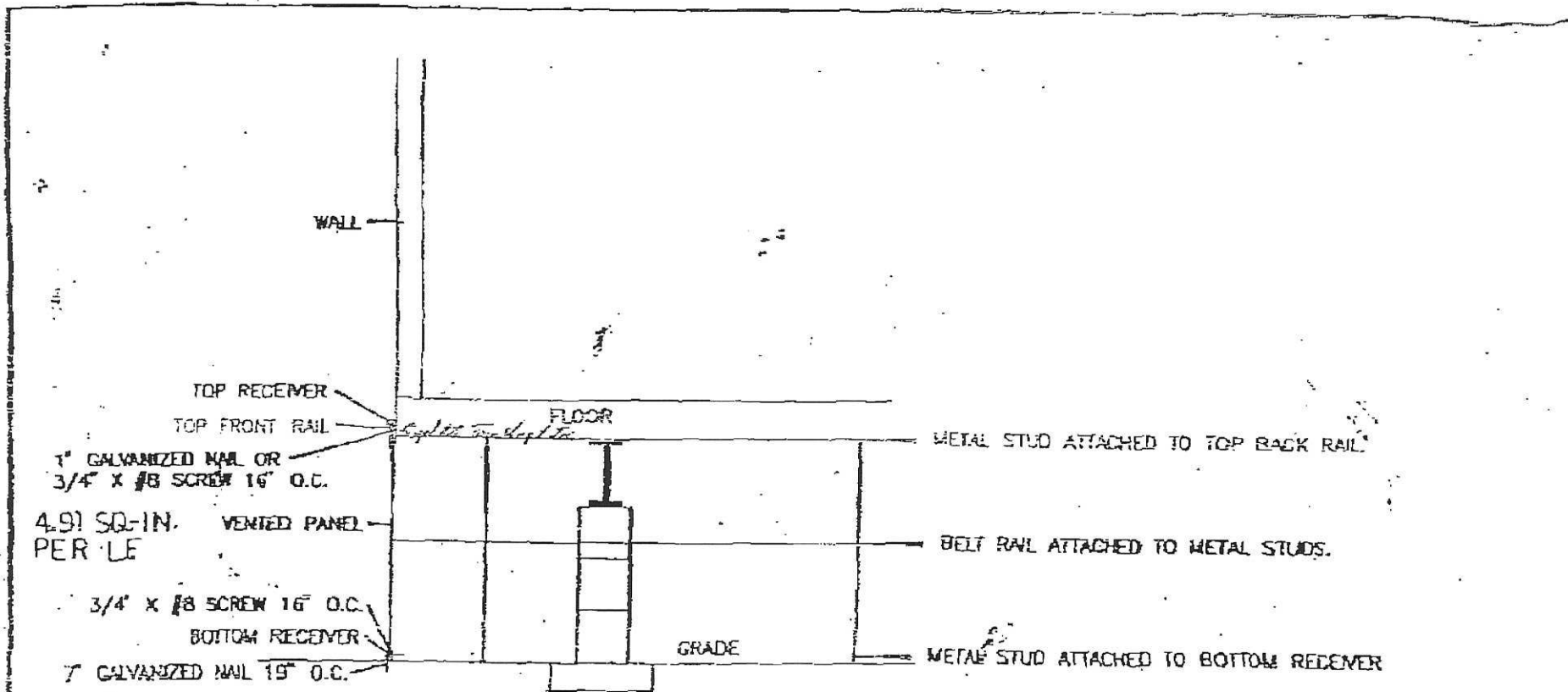

TYPICAL CRAWL SPACE WALL SECTION

1/2" = 1"

SIZE AND LOCATION OF ACCESS DOOR TO BE PLACED TO COORDINATE WITH WATER CUT-OFFS. ACCESS TO BE 18" X 24" MINIMUM.

PER MARION COUNTY REQUEST, SCREWS TO BE INSTALLED AT TOP AND BOTTOM OF EACH PANEL.

ANY HOME HAVING IN EXCESS OF 36" HEIGHT MUST HAVE VERTICAL STUDS EVERY 48" WITH BELT RAIL INSTALLED FOR BLOW OUT PROTECTION.