



# Mobile Home Permit Worksheet

Installer: Brent Strickland License # IH1104218

Address of home being installed 1685 NW Ogden Loop Lake City FL

Manufacturer Champion Length x width 64X26'8"

**NOTE:** If home is a single wide fill out one half of the blocking plan  
If home is a triple or quad wide sketch in remainder of home

I understand Lateral Arm Systems cannot be used on any home (new or used) where the sidewall ties exceed 5 ft 4 in.

Installer's initials BS

Typical pier spacing

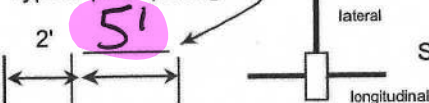

Show locations of Longitudinal and Lateral Systems (use dark lines to show these locations)

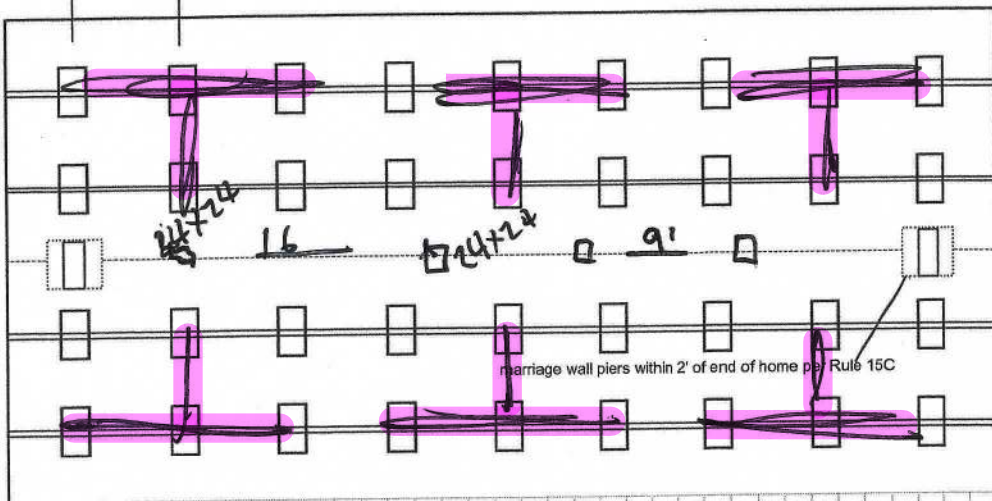

marriage wall piers within 2' of end of home per Rule 15C



Permit Number: \_\_\_\_\_ Date: \_\_\_\_\_

New Home  Used Home

Home installed to the Manufacturer's Installation Manual   
Home is installed in accordance with Rule 15-C

Single wide  Wind Zone II  Wind Zone III

Double wide  Installation Decal # 116799

Triple/Quad  Serial # \_\_\_\_\_

### PIER SPACING TABLE FOR USED HOMES

Load bearing capacity	Footer size (sq in)	16" x 16" (256)	18 1/2" x 18 1/2" (342)	20" x 20" (400)	22" x 22" (484)*	24" X 24" (576)*	26" x 26" (676)
1000 psf	3'	4'	5'	6'	7'	8'	
1500 psf	4'6"	6'	7'	8'	8'	8'	
2000 psf	6'	8'	8'	8'	8'	8'	
2500 psf	7'6"	8'	8'	8'	8'	8'	
3000 psf	8'	8'	8'	8'	8'	8'	
3500 psf	8'	8'	8'	8'	8'	8'	

\*interpolated from Rule 15C-1 pier spacing table.

### PIER PAD SIZES

I-beam pier pad size 17x25

Perimeter pier pad size 16x16

Other pier pad sizes (required by the mfg.) \_\_\_\_\_

Draw the approximate locations of marriage wall openings 4 foot or greater. Use this symbol to show the piers.

List all marriage wall openings greater than 4 foot and their pier pad sizes below.

Opening	Pier pad size
<u>9'</u>	<u>17x25</u>
<u>12'</u>	<u>24x24</u>

### POPULAR PAD SIZES

Pad Size	Sq In
16 x 16	256
16 x 18	288
18.5 x 18.5	342
16 x 22.5	360
17 x 22	374
13 1/4 x 26 1/4	348
20 x 20	400
17 3/16 x 25 3/16	441
17 1/2 x 25 1/2	446
24 x 24	576
26 x 26	676

4 ft  5 ft

**ANCHORS**

**FRAME TIES**

within 2' of end of home spaced at 5' 4" oc \_\_\_\_\_

**OTHER TIES**

	Number
Sidewall	<u>30</u>
Longitudinal	<u>6</u>
Marriage Wall	<u>2</u>
Shear Wall	<u>2</u>

### TIEDOWN COMPONENTS

**Longitudinal Stabilizing Device (LSD)**

Manufacturer \_\_\_\_\_

**Longitudinal Stabilizing Device w/ Lateral Arms**

Manufacturer Oliver



# Mobile Home Permit Worksheet

Permit Number: \_\_\_\_\_

Date: \_\_\_\_\_

## POCKET PENETROMETER TEST

The pocket penetrometer tests are rounded down to \_\_\_\_\_ psf or check here to declare 1000 lb. soil  without testing.

X \_\_\_\_\_ X \_\_\_\_\_ X \_\_\_\_\_

## POCKET PENETROMETER TESTING METHOD

1. Test the perimeter of the home at 6 locations.
2. Take the reading at the depth of the footer.
3. Using 500 lb. increments, take the lowest reading and round down to that increment.

X \_\_\_\_\_ X \_\_\_\_\_ X \_\_\_\_\_

## TORQUE PROBE TEST

The results of the torque probe test is 295 inch pounds or check here if you are declaring 5' anchors without testing \_\_\_\_\_. A test showing 275 inch pounds or less will require 5' anchors.

**Note:** A state approved lateral arm system is being used and 4 ft. anchors are allowed at the sidewall locations. I understand 5' anchors are required at all centerline tie points where the torque test reading is 275 or less and where the mobile home manufacturer may require anchors with 4000 lb. holding capacity.

Installer's initials BS

### ALL TESTS MUST BE PERFORMED BY A LICENSED INSTALLER

Installer Name Brent Strickland

Date Tested 2/5/26

## ELECTRICAL

Connect electrical conductors between multi-wide units, but not to the main power source. This includes the bonding wire between multi-wide units. Pg. \_\_\_\_\_

## PLUMBING

Connect all sewer drains to an existing sewer tap or septic tank. Pg. \_\_\_\_\_

Connect all potable water supply piping to an existing water meter, water tap, or other independent water supply systems. Pg. \_\_\_\_\_



## Site Preparation

Debris and organic material removed    
Water drainage: Natural \_\_\_\_\_ Swale \_\_\_\_\_ Pad \_\_\_\_\_ Other \_\_\_\_\_

## Fastening multi wide units

Floor- Type Fastener: Lags Length: 6" Spacing: 24  
Walls- Type Fastener: SCWS Length: 4" Spacing: 10" OC  
Roof- Type Fastener: Lags Length: 6" Spacing: 24

For used homes a min. 30 gauge, 8" wide, galvanized metal strip will be centered over the peak of the roof and fastened with galv. roofing nails at 2" on center on both sides of the centerline.

## Gasket (weatherproofing requirement)

I understand a properly installed gasket is a requirement of all new and used homes and that condensation, mold, mildew and buckled marriage walls are a result of a poorly installed or no gasket being installed. I understand a strip of tape will not serve as a gasket.

Type gasket factory foam  
Pg. \_\_\_\_\_

Installer's initials BS

Installed: \_\_\_\_\_  
Between Floors-----Yes   
Between Walls-----Yes   
Bottom of ridge beam---Yes \_\_\_\_\_

## Weatherproofing

The bottom board will be repaired and/or taped-----Yes  Pg. \_\_\_\_\_  
Siding on units is installed to manufacturer's specifications-----Yes   
Fireplace chimney installed so as not to allow intrusion of rain water---Yes \_\_\_\_\_

## Miscellaneous

Skirting to be installed.-----Yes  No \_\_\_\_\_ N/A \_\_\_\_\_  
Dryer vent installed outside of skirting.-----Yes  No \_\_\_\_\_ N/A \_\_\_\_\_  
Range downflow vent installed outside of skirting.---Yes \_\_\_\_\_ No \_\_\_\_\_ N/A \_\_\_\_\_  
Drain lines supported at 4' intervals.-----Yes  No \_\_\_\_\_ N/A \_\_\_\_\_  
Electrical crossovers protected.-----Yes \_\_\_\_\_ No \_\_\_\_\_ N/A \_\_\_\_\_  
Other: \_\_\_\_\_

Installer verifies all information given with this permit worksheet is accurate and true based on the manufacturer's installation instructions and or Rule 15C-1 & 2

Installer's Signature \_\_\_\_\_

Date 2/5/26

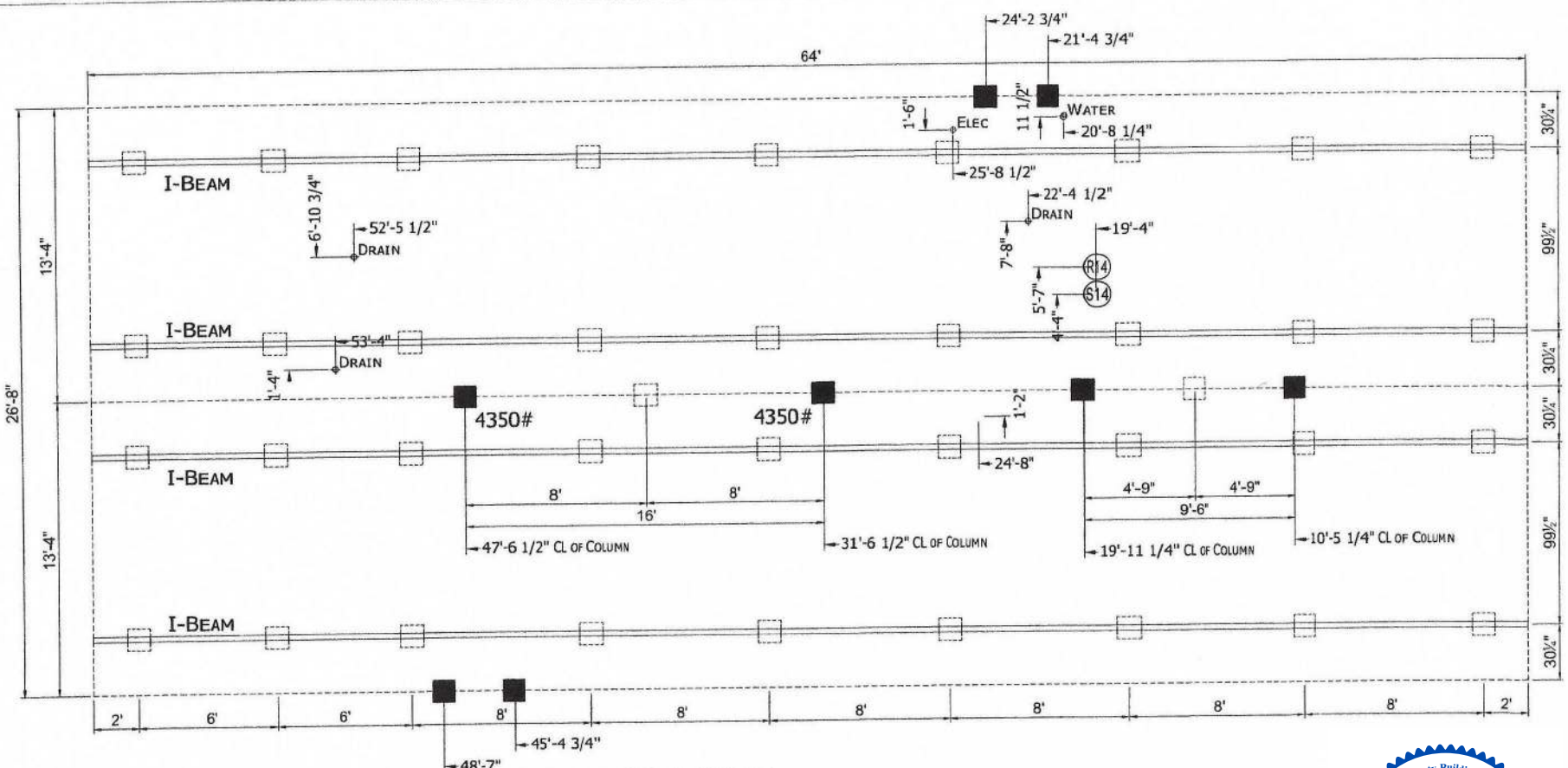

Column Blocking  
 See Soil Bearing Capacity Charts for Pad Size  
 Blocking

- 1) All Exterior Doors, Bay Windows, Recessed Sidewalls and Exterior Wall Openings 48" or Greater Will Require Blocking on Each Side.



**CHAMPION**  
 MANUFACTURED BEAUTIFULLY™  
 P.O. BOX 2097 HWY 100 EAST LAKE CITY, FL 32056

MODIFICATIONS

PROJECT: 261-2864H42A7C  
 64'-0" x 26'-8"  
 4 BD 2 BT  
 DRAWN BY: BOR  
 DATE: 01-03-25  
 SCALE: 5/32" = 1'-0"

TITLE: **PIER FOUNDATION PLAN**  
 FILENAME: 2864H42A7C

**PR-101**

PROPRIETARY AND CONFIDENTIAL  
 THIS DRAWING AND SPECIFICATIONS ARE ORIGINAL  
 PROPRIETARY AND CONFIDENTIAL MATERIALS OF CHAMPION  
 COPYRIGHT © 1976-2015 BY CHAMPION

Order #: 6467	Label #: 116799	Manufacturer: <i>Champion</i>	(Check Size of Home)
Homeowner: <i>Legacy Investments</i>		Year Model: <i>2026</i>	Single _____
Address: <i>1685 Ogden Loop</i>		Length & Width: <i>28x64</i>	Double <u><i>2</i></u>
City/State/Zip: <i>Lake City FL</i>		Type Longitudinal System:	Triple _____
Phone #:		Type Lateral Arm System: <i>oliver</i>	HUD Label #:
Date Installed:		New Home: <u><i>X</i></u> Used Home: _____	Soil Bearing / PSF:
Installed Wind Zone:		Data Plate Wind Zone:	Torque Probe / in-lbs:
Note:			Permit #:



**STATE OF FLORIDA  
INSTALLATION CERTIFICATION LABEL**

116799

LABEL #

DATE OF INSTALLATION

BRENT STICKLAND

NAME

IH / 1104218 / 1

6467

LICENSE #

ORDER #

CERTIFIES THAT THE INSTALLATION OF THIS MOBILE HOME IS IN ACCORDANCE WITH FLORIDA STATUTES 320.8249, 320.8325 AND RULES OF THE HIGHWAY SAFETY AND MOTOR VEHICLES.

**INSTRUCTIONS**

PLEASE WRITE DATE OF INSTALLATION AND AFFIX LABEL NEXT TO HUD LABEL. USE PERMANENT INK PEN OR MARKER ONLY. COMPLETE INFORMATION ABOVE AND KEEP ON FILE FOR A MINIMUM OF 2 YEARS. YOU ARE REQUIRED TO PROVIDE COPIES WHEN REQUESTED.

**OLIVER TECHNOLOGIES, INC.**  
**FLORIDA INSTALLATION INSTRUCTIONS FOR THE**  
**MODEL 1101 "V" SERIES ALL STEEL FOUNDATION SYSTEM**

**MODEL 1101 "V" (Steps 1-14)**

**LONGITUDINAL ONLY: Follow Steps 1-9**

**LATERAL ONLY: Follow Steps 1-3 and Steps 10-14**

**FOR CONCRETE APPLICATIONS: Follow Steps 15-18**



ENGINEERS STAMP



1. **SPECIAL CIRCUMSTANCES:** If the following conditions occur - **STOP! Contact Oliver Technologies at 1-800-284-7437 :**

- a) Pier height exceeds 48"
- b) length of home exceeds 76'
- c) Roof eaves exceed 16"
- d) Sidewall height exceed 96"
- e) Location is within 1500 feet of coast

**INSTALLATION OF GROUND PAN**

- 2. Remove weeds and debris in an approximate two foot square to expose firm soil for each ground pan (C) .
- 3. Place ground pan (C) directly below chassis I-beam. Press or drive pan firmly into soil until flush or below soil then install pier per manufacturer's instructions or per Florida Regs.

**SPECIAL NOTE:** The longitudinal "V" brace system may also serve as a pier under the home and should be loaded as any other pier. It is recommended that after leveling piers, and one-third inch (1/3") before home is lowered completely on to piers, complete steps 4 through 9 below then remove jacks.

**INSTALLATION OF LONGITUDINAL "V" BRACE SYSTEM (Model 1101 L "V")**

**NOTE:** WHEN INSTALLING THE LONGITUDINAL SYSTEM ONLY, A MINIMUM OF 2 SYSTEMS PER FLOOR SECTION IS REQUIRED. SOIL TEST PROBE SHOULD BE USED TO DETERMINE CORRECT TYPE OF ANCHOR PER SOIL CLASSIFICATION. IF PROBE TEST READINGS ARE BETWEEN 175 & 275 A 5 FOOT ANCHOR MUST BE USED. IF PROBE TEST READINGS ARE BETWEEN 276 & 350 A 4 FOOT ANCHOR MAY BE USED. USE GROUND ANCHORS WITH DIAGONAL TIES AND STABILIZER PLATES EVERY 5'4" . VERTICAL TIES ARE ALSO REQUIRED ON HOMES SUPPLIED WITH VERTICAL TIE CONNECTION POINTS (PER FLORIDA REG.).

- 4. Choose one of the approved longitudinal tube installations; either Diagram A or B. Then select the correct square tube (E) length from the diagram for appropriate pier height at support location or cut and drill 1.5" square tube to achieve appropriate length.

PIER HEIGHT (40° Min. - 45° Max.)	1.25" Tube Length	1.50" Tube Length
7 3/4" to 25"	22"	18"
24 3/4" to 32 1/4"	32"	18"
33" to 41"	44"	18"
40" to 48"	54"	18"

Diagram A

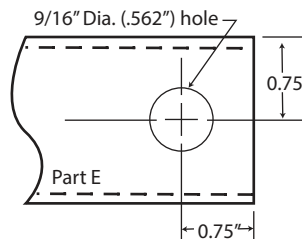

PIER HEIGHT (40° Min. - 60° Max.)	1.50" Tube Length
14" to 18"	20"
18" to 25"	28"
24" to 35"	39"
30" to 40"	44"
36" to 48"	54"

Diagram B

- 5. Install (2) of the 1.50" square tubes (E) into the "U" bracket (J), insert carriage bolt and leave nut loose for final adjustment.
- 6. Place I-beam connector (F) loosely on the bottom flange of the I-beam.
- 7. (For Diagram A installation) Slide the selected 1.25" tube (E) into a 1.50" tube (E) and attach to I-beam connectors (F) and fasten loosely with bolt and nut. (For Diagram B installation) Attach the selected 1.5" tubes (E) to the I-beam connectors (F) and fasten loosely with bolts and nuts.
- 8. Repeat steps 6 through 7 to create the "V" pattern of the square tubes loosely in place.
- 9. Using standard hand tools tighten all nuts and bolts. (For Diagram A installation only, secure 1.25" and 1.50" tubes using four(4) 1/4"-14 x 3/4" self-tapping screws in pre-drilled holes.)

**INSTALLATION OF LATERAL TELESCOPING TRANSVERSE ARM SYSTEM (Model 1101 T "V")**

THE MODEL 1101 "V" (LONGITUDINAL & LATERAL PROTECTION) ELIMINATES THE NEED FOR STABILIZER PLATES & FRAME TIES.

**NOTE:** THE USE OF THIS SYSTEM REQUIRES VERTICAL TIES SPACED AT 5'4".

FOUR FOOT (4') GROUND ANCHOR MAY BE USED EXCEPT WHERE THE HOME MANUFACTURER SPECIFIES DIFFERENT.

- 10. Install remaining vertical tie-down straps and 4' ground anchors per home manufacturer's instructions. NOTE: Centerline anchors to be sized according to soil torque condition. Any manufacturer's specifications for sidewall anchor loads in excess of 4,000 lbs. require a 5' anchor per Florida Code.
- 11. Select the correct square tube brace (H) length for set-up lateral transverse at support location. The lengths come in either 60" or 72" lengths. (With the 1.50" tube as the bottom tube, and the 1.25" tube as the inserted tube.)
- 12. Install the 1.50 transverse brace (H) to the ground pan connector (D) with bolt and nut.
- 13. Slide 1.25" transverse brace into the 1.50" brace and attach to adjacent I-beam connector (I) with bolt and nut.
- 14. Secure 1.50" transverse arm to 1.25" transverse arm using four (4) 1/4" - 14 x 3/4" self-tapping screws in pre-drilled holes.

**INSTALLATION USING CONCRETE RUNNER/ FOOTER**

15. A concrete runner, footer or slab may be used in place of the steel ground pan.
  - a) The concrete shall be minimum 2500 psi mix
  - b) A concrete runner may be either longitudinal or transverse, and must be a minimum of 8" deep with a minimum width of 16 inches longitudinally or 18 inches transverse to allow proper distance between the concrete bolt and the edge of the concrete (see below).
  - c) Footers must have minimum surface area of 441 sq. in. (I.e. 21" square), and must be a minimum of 8" deep.
  - d) If a full slab is used, the depth must be a 4" minimum . Special inspection of the system bracket installation is not required. Footers must allow for at least 4" from the concrete bolt to the edge of the concrete.

**NOTE:** The bottom of all footings, pads, slabs and runners must be per local jurisdiction.

**LONGITUDINAL: (Model 1101 LC "V")**

16. When using Part# 1101-W-CPCA (wetset) simply install the bracket in runner/footer **OR** When installing in cured concrete use Part# 101-D-CPCA (dryset). The 1101 (dryset) CA bracket is attached to the concrete using (2) 5/8"x3" concrete wedge bolts (Simpson part # S162300H 5/8" X 3" or Powers equivalent). Place the CA bracket in desired location. Mark bolt hole locations, then using a 5/8" diameter masonry bit, drill a hole to a minimum depth of 3". Make sure all dust and concrete is blown out of the holes. Place wedge bolts into drilled holes, then place 1101 (dry set) CA bracket onto wedge bolts and start wedge bolt nuts. Take a hammer and lightly drive the wedge bolts down by hitting the nut (making sure not to hit the top of threads on bolt). The sleeve of concrete wedge bolt needs to be at or below the top of concrete. Complete by tightening nuts.

**LATERAL: (Model 1101 TC "V")**

17. For wet set (part # 1101-W-TACA) installation simply install the anchor bolt into runner/footer. For dry set installation (part # 1101-D-TACA) mark bolt hole locations, then using a 5/8" diam. masonry bit. drill a hole to a minimum depth of 3". Make sure all dust and concrete is blown out of the hole. Place wedge bolts (Simpson part #S162300H 5/8" X 3" or Powers equivalent) into (D) concrete dry transverse connector and into drilled hole. If needed, take a hammer and lightly drive the wedge bolts down by hitting the nut (making sure not to hit the top of threads on bolt), then remove the nut. The sleeve of concrete wedge bolt needs to be at or below the top of concrete.
18. When using part# 1101 CVW (wetset) or 1101 CVD (dryset), install per steps 17 & 18.

**Notes:**

1. LENGTH OF HOUSE IS THE ACTUAL BOX SIZE
2. = LOCATION OF TRANSVERSE BRACING ONLY
3. = LOCATION OF LONGITUDINAL BRACING ONLY
4. = TRANSVERSE AND LONGITUDINAL LOCATIONS

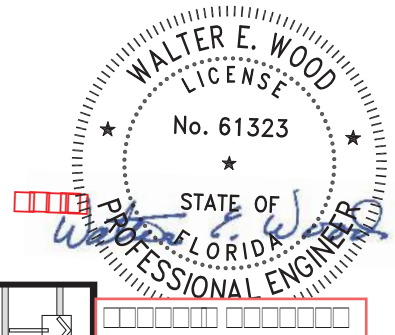

ALL WIDTHS AND LENGTHS UP TO 52'

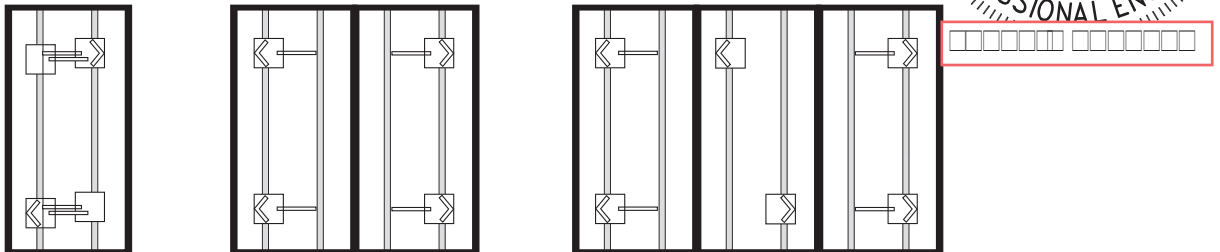

ALL WIDTHS AND LENGTHS OVER 52' TO 80"

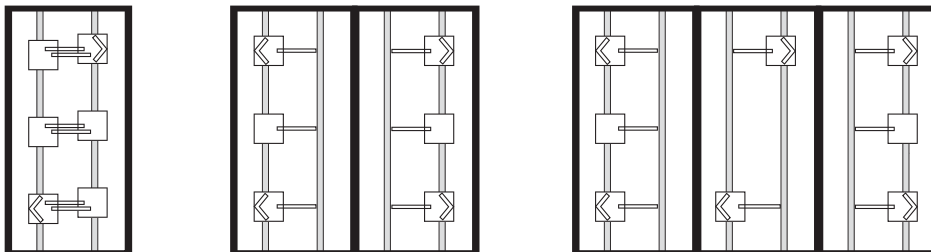

HOMES WITH 5/12 ROOF PITCH REQUIRE: PER FLORIDA REGULATIONS  
6 systems for home lengths up to 52' and 8 systems for homes over 52' and up 80'.

PATENT# 6634150 & OTHER PATENT PENDING

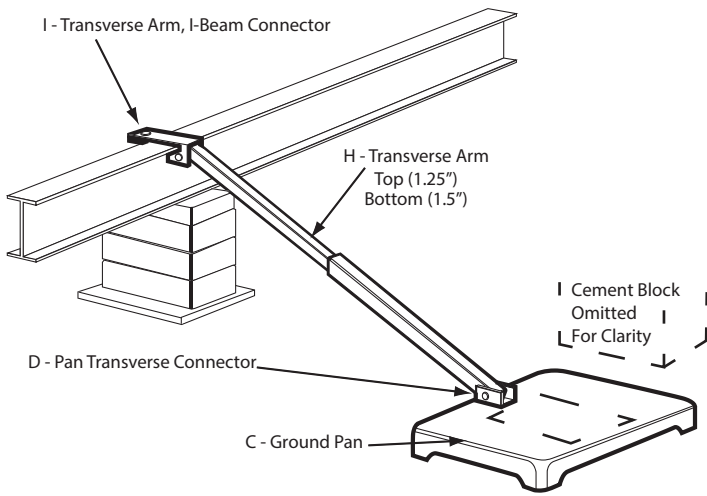

**Model # 1101 T "V"**

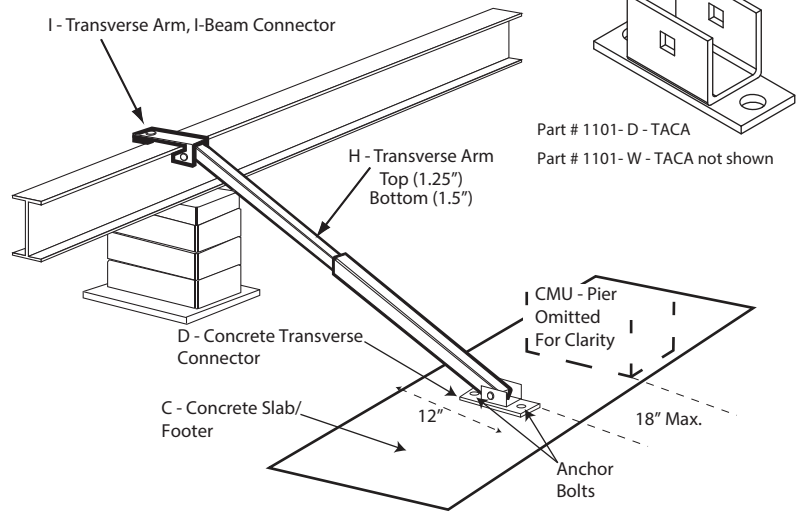

**Model # 1101 TC "V"**

Florida approved 4' ground anchors may be used in all locations except where home manufacturers specifications for sidewall straps are in excess of 4,000 lbs. These locations require a 5' anchor. Per Florida code.

C = GROUND PAN / CONCRETE FOOTER OR RUNNER

D = GROUND PAN / CONCRETE U BRACKETS TRANSVERSE CONNECTOR (connects with grade 5 - 1/2" x 2" 1/2" carriage bolt and nut)

E = TELESCOPING V BRACE TUBE ASSEMBLY (1.5" TUBE BOTTOM AND 1.25" TUBE INSERT) OR 1.5" TUBE

F = "V" BRACE I-BEAM CONNECTOR ASSEMBLY

H = TELESCOPING TRANSVERSE ARM ASSEMBLY

I = TRANSVERSE ARM I-BEAM CONNECTOR (connects with grade 5 - 1/2" x 2" 1/2" carriage bolt and nut)

J = V PAN BRACKET (connects with grade 5 - 1/2" x 2" 1/2" carriage bolt and nut)

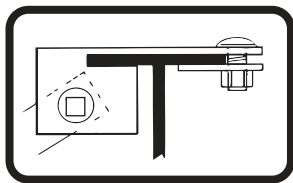

I - Transverse Arm, I-Beam Connector

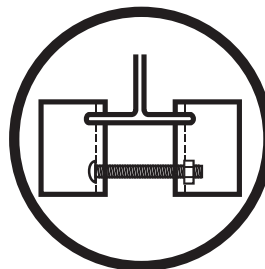

F - "V" Brace I-Beam Connectors

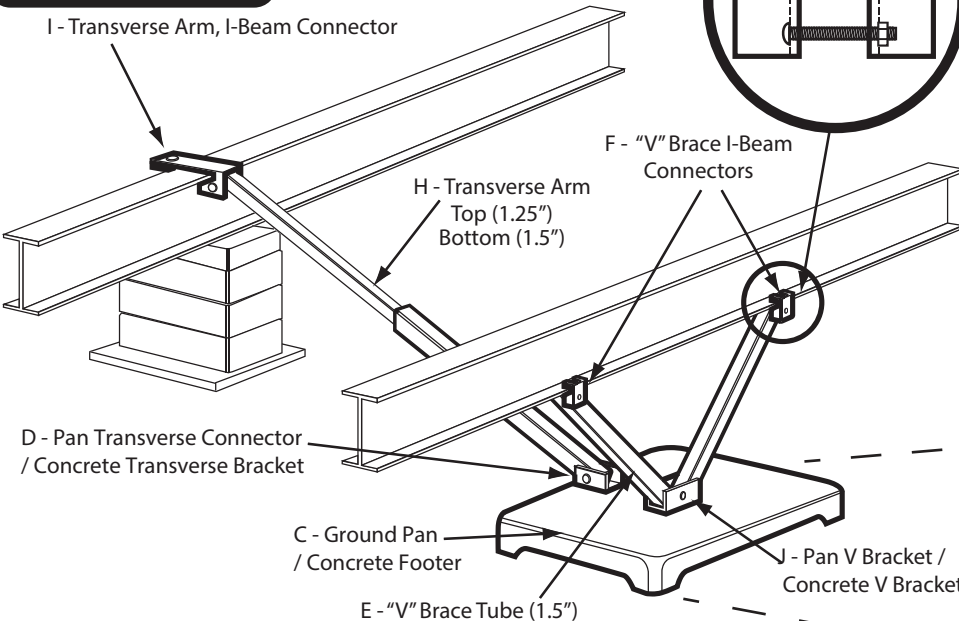

**Model # 1101 "V"**

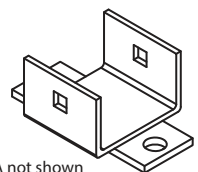

Part# 1101 D-CPCA

Part # 1101 W-CPCA not shown

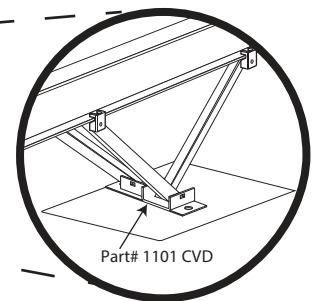

Part# 1101 CVD

**Model # 1101 C "V"**

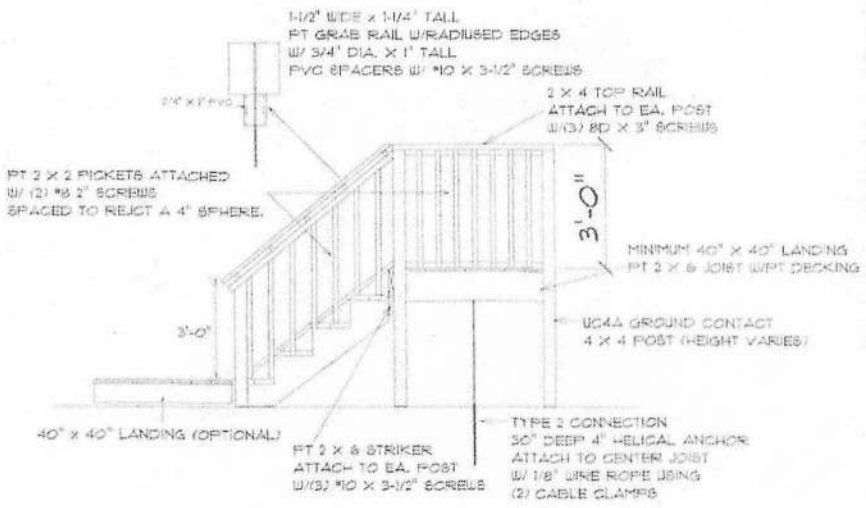

40" x 40" STEPS  
SCALE: 3/4" = 1'-0"

NOTES:

1. STEPS HAVE A MIN. 40" X 40" LANDING
2. STEPS HAVE A RISER HEIGHT OF BETWEEN 6.75" TO 7.75"
3. HANDRAIL HEIGHT 36"
4. STEPS TO HAVE MIN. 10" TREAD DEPTH.
5. PICKETS TO BE SPACED TO REJECT A 4" SPHERE.
6. STEPS TO MEET TREAD TO RISER RATIO- 2 RISES + 1 TREAD = 24" - 25"
7. FLIGHT OF STAIRS NOT TO HAVE VERTICAL RISES GREATER THAN 12' BETWEEN LANDINGS.

*Ray E. Risner P.E.*  
11/11/24

RAY E. RISNER P.E. #32124  
PO BOX 3  
SUWANNEE, FL. 32692  
352-318-1356



STEP RITE SOLUTIONS

PHONE:  
FAX:  
MOBILE:

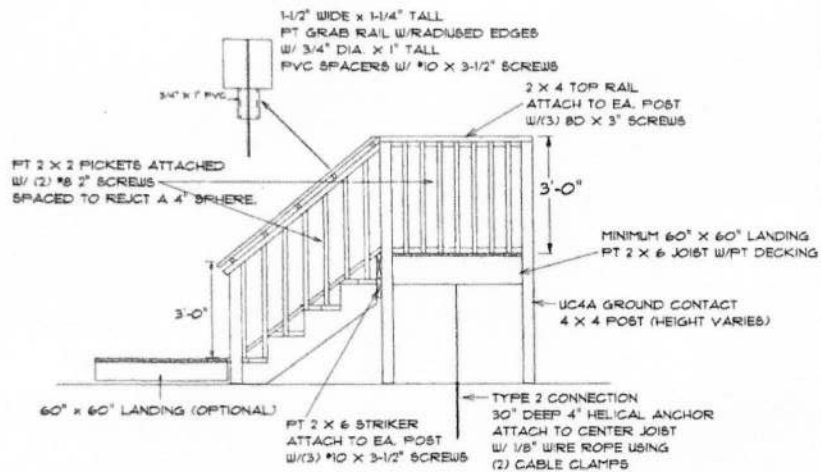

60" x 60" STEPS  
SCALE 3/4" = 1'-0"

NOTES:

1. STEPS HAVE A MIN. 60" X 60" LANDING
2. STEPS HAVE A RISER HEIGHT OF BETWEEN 6.75" TO 7.75"
3. HANDRAIL HEIGHT 36"
4. STEPS TO HAVE MIN. 10" TREAD DEPTH,
5. PICKETS TO BE SPACED TO REJECT A 4" SPHERE
6. STEPS TO MEET TREAD TO RISER RATIO-  
2 RISES + 1 TREAD = 24" - 25"
7. FLIGHT OF STAIRS NOT TO HAVE VERTICAL RISES GREATER THAN 12' BETWEEN LANDINGS.



SECTION LETTER: A  
PAGE NUMBERS: 11

STEP RITE SOLUTIONS  
PHONE:  
FAX  
MOBILE:

RAY E. RISNER  
11/11/24  
PROFESSIONAL ENGINEER  
STATE OF FLORIDA

RAY E. RISNER P.E. #33724  
PO BOX 3  
SUWANNEE, FL. 32692  
352-318-1356

## Installation Details

Careful attention to a few basic details will insure that your vinyl skirting will provide a beautiful, easily installed, completely accessible exterior with a minimum of maintenance. Vinyl skirting is easily installed over any terrain, requires no special tools and never needs painting. Following these basic installation techniques will assure that our skirting will contribute to the beauty of your home's exterior.

## Tools you will need

Hammer • Screwdriver • Snips • Plumb Bob or Level • Tape Measure  
Power Saw with Fine Tooth Blade • Snap Lock Tool • Chalk Line  
• Utility Knife

### *Important*

- 1) Use either a power saw with a fine tooth blade mounted with reverse rotation, or aviation snips to cut skirting components.
- 2) To allow for normal expansion and contraction, fasten the Top Trim Back component(s) in the center of the nailing slots. Fasten positively to the surface of the unit at every slotted hole, leaving 1/2" between lengths. **Do not butt the ends.** Overlap the Top Trim Front component(s) approximately 1" at joints. Allow 1/2" between pieces of the Bottom Channel component(s) when installing.
- 3) **Do not drive the fasteners too tightly.** Nails or screws offer excellent holding power, but if driven too tightly, the vinyl can, under normal expansion and contraction, become distorted. These fasteners should be driven in the middle of the nailing slot just short of touching the Top Trim Back component(s). Nail or screw to achieve 3/4" penetration into a solid wood substance. Fasten to allow part to expand and contract during the normal change in ambient temperature. **Do not fasten tight.** Allow 1/16" gap between fastener head and part.

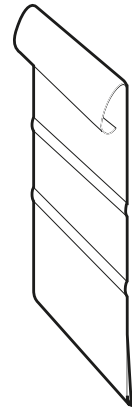

Top Trim Back Component

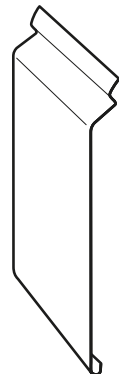

Top Trim Front Component

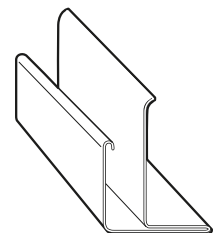

Bottom Channel Component

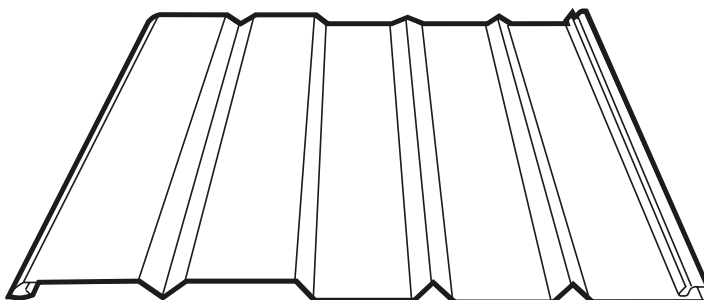

Skirting Panel

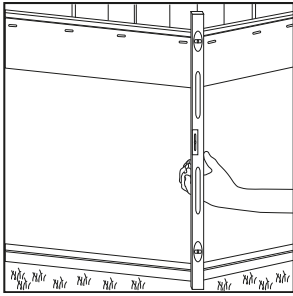

Figure 1

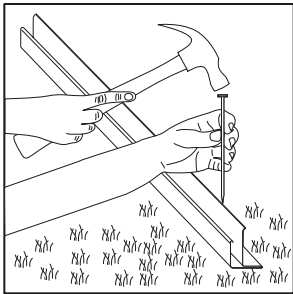

Figure 2

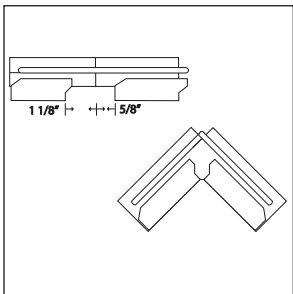

Figure 3

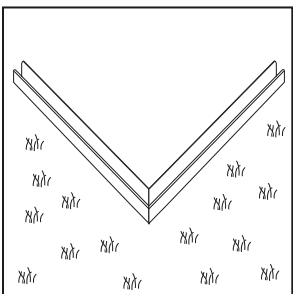

Figure 4

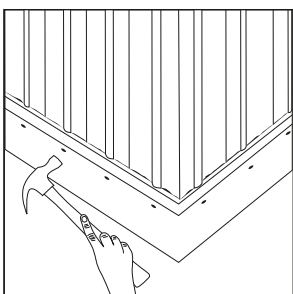

Figure 5

## Step 1...

### Laying the Bottom Channel Components

A level or plumb line should be used to establish the location of the Bottom Channel. The taller backside of the Bottom Channel should be located directly beneath the outside bottom edge of the home, where the Top Trim Back component will be attached (*see figure 1*). To prevent grass from growing around the base of the skirting and provide a non-shifting base for the ground spikes, 9" asphalt roof starter should be installed around the home. The roof starter also reduces the possibility of the vinyl skirting panels being damaged from the use of a powered string trimmer. "Weed-Eater" type trim units will damage the skirting and is not covered by the warranty.

Attach the Bottom Channel component directly to the ground through the prepunched holes (*see figure 2*). Spikes are required every 24 inches...extra holes are provided in the Bottom Channel component for convenience. Another spike or a drift punch may be used to drive spikes in completely. To allow for expansion, leave a 1/2" gap between each section of the Bottom Channel component. To form clean, attractive corners, the Bottom Channel component can be notched with snips (*see figure 3*) and then bent to the desired angle. (*Attached to the ground as shown in figure 4*).

**Note:** in high wind areas; where ground below the unit is spongy; or where ground is loose from recent excavation and has not yet settled, it is advisable to fasten bottom channel to treated wooden stakes. For installation on concrete, use 3/4" masonry nail instead of ground spike. "Liquid Nail" cement or other similar methods of setting a fastener directly to concrete can also be used.

## Step 2...

### Mounting Top Trim Back Components

First determine where the Top Trim Back component(s) will mount on the lower part of the home. The bottom edge of the Top Trim Back component can extend below the bottom edge of the home if there is a solid support for nailing and a solid bearing for the Top Trim Front component against the side of the home. It is helpful to mark a line around the bottom of the home with a chalk line or other method to assure a straight line where the Top Trim Back component is to be installed.

The Top Trim Back component is installed by driving the fasteners in the middle of every slot (*see figure 5*). **Do not fasten tightly!** (see fastening instructions on front page.) **Do not cut Top Trim Back components at the corners.** Gently bend over a sharp edge of a cutting table or a similar surface to form a corner (*see figure 6*).

If the installation is made in extremely cold weather, the vinyl should be warmed to room temperature before bending. Warming will avoid the likelihood of cracking.

## Step 3...

### Cutting Top Trim Back Components

The Top Trim Back component is constructed with two parallel ridges at intervals below the nailing slots (see figure 7). These ridges may be used to measure the distance from the ground to the lower ridge. In cold weather, measure to the top ridge; In warm weather, measure to the bottom ridge. If the ground is level, several panels may be cut at one time using a hand power saw. **Remember, if a power saw is to be used, mount a fine-toothed blade in reverse position** (see figure 8).

### Locking the Skirting Panels

A snap lock tool is used to punch locking tabs on the outside bottom edge of each skirting panel (see figure 9). When the panel is installed, it becomes locked in the Bottom Channel component. This feature assures retention of the panel in the Bottom Channel. **Note:** When installing in a high wind area, you may also punch locking tabs at the top of the panel for added locking strength.

Self-aligning panels easily snap and slide into place (see figure 10). Be certain that each skirting panel positively interlocks with the skirting panel adjoining it.

**Note:** (above 36" panel height, a framing support system should be considered.)

### Installing the Skirting Panels

Panel can be installed by setting into the Bottom Channel and leaning against the top trim back. Lock the next panel as shown in figure 10. Panels should not be cut but bent around corners as shown in figure 11.

### Fitting Skirting Panels Around Service Connections

Cutting and fitting to virtually any shape or radius is easily done with Vinyl Skirting. Using aviation snips, cut the panel to fit around the connection. Cut the panel from the side – **not from the top or bottom**. Keep snip points open as if cutting cloth to avoid cracking panels.

### CAUTION

Proper installation of manufactured home skirting requires that the Top Back component be fastened loosely so the panel will slide freely in the nail slots. This can be accomplished by leaving the fastener 1/16" to 1/8" from the face of the panel. The fastener must penetrate a solid surface by 3/4".

*Do not place outdoor cookers near the vinyl skirting because the heat will distort the panels. Any heat source must be kept away from the panels or damage may occur.*

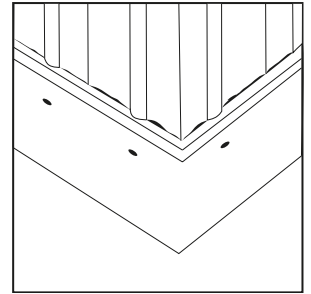

Figure 6

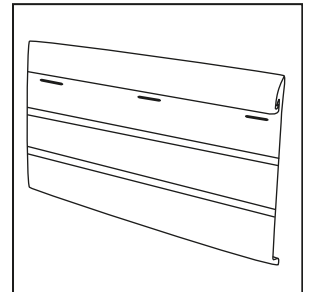

Figure 7

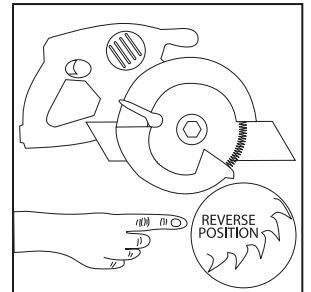

Figure 8

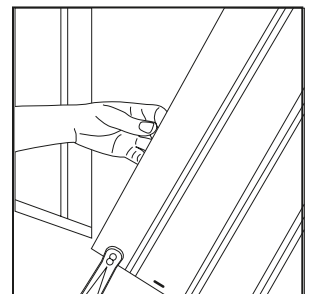

Figure 9

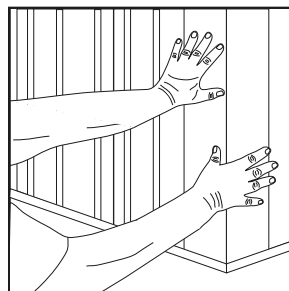

Figure 11

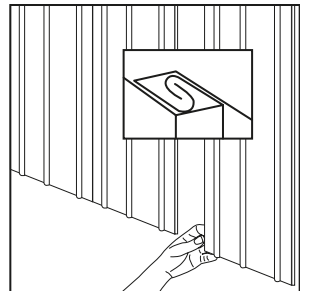

Figure 10

## Step 4...

### Installing the Top Trim Front Component

The Top Trim Front component(s) installs easily by snapping the top edge of its spring lock into the installed Top Trim Back component. Be sure to push the Top Trim Front component all the way into the Top Trim Back component **until it “snaps” into place.**

Each of the 15 pieces of the Top Trim Front components in the trim kit are notched 2" on one end (see figure 12) to permit overlapping. Overlap ends of adjoining Top Trim Front component(s) approximately 1".

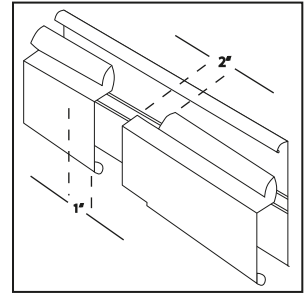

Figure 12

### Cutting Additional Corners

If inside corners are needed, trim strips can be easily cut with aviation snips to form attractive corner joints by cutting a 45° mitre on adjacent ends and butting. If extra outside corners are required (for porches or add-on rooms), notch the trim strips as shown (see figure 13), bend around the corner and snap into place. Allow at least 3' of trim strip on each side of the corner.

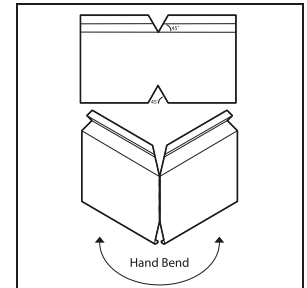

Figure 13

### Easy Access

Access can be gained at virtually any point by simply lifting the Top Trim Front component and sliding out the desired number of panels. Accessibility to the area under the unit is available whenever desired.

### Final Configuration

Please review the drawing to the right that shows how the components and skirting panels look after installation is complete.

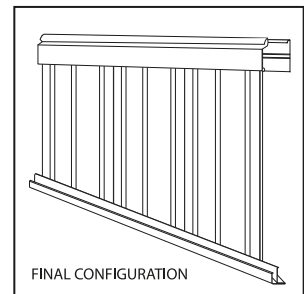
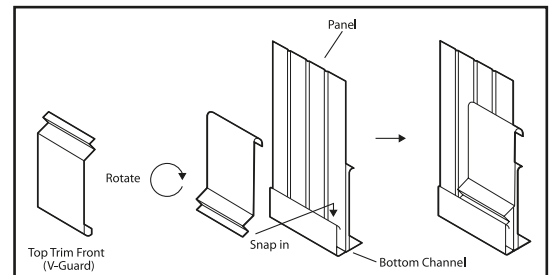

Figure 14

## V-Guard Installation - (if applicable)

### Installing the V-Guard Component

V-Guard Vinyl Skirting Protector component(s) installs easily by snapping the bottom edge of its spring lock into the Bottom Channel component. Be sure to push the V-Guard trim all the way into the Bottom Channel component **until it “snaps” into place.** (see figure 14)



### Cutting additional corners

If inside corners are needed, V-Guard trim can be easily cut with aviation snips to form attractive corner joints by cutting a 45° mitre on adjacent ends and butting. If extra outside corners are required (for porches or add-on rooms), notch the V-Guard trim component, bend around the corner and snap into place. Allow at least 3" of V-Guard component trim on each side of the corner.



Style Crest, Inc.  
2450 Enterprise St.  
Fremont, Ohio 43420  
800.945.4440  
www.stylecrestproducts.com