

Mobile Home Permit Worksheet

Installer: Jacob Trowell License # IH1148380

Address of home: 1884 SW Halkwanger Road Lake City FL
 being installed

Manufacturer: Live Oak Length x width: 76X16

NOTE: If home is a single wide fill out one half of the blocking plan. If home is a triple or quad wide sketch in remainder of home. I understand Lateral Arm Systems cannot be used on any home (new or used) where the sidewall ties exceed 5 ft 4 in.

Typical pier spacing: 2' 4 1/2"

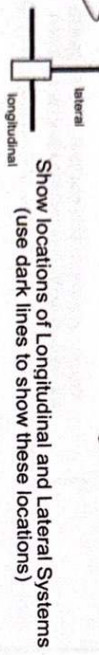

Show locations of Longitudinal and Lateral Systems (use dark lines to show these locations)

Installer's initials: [Signature]

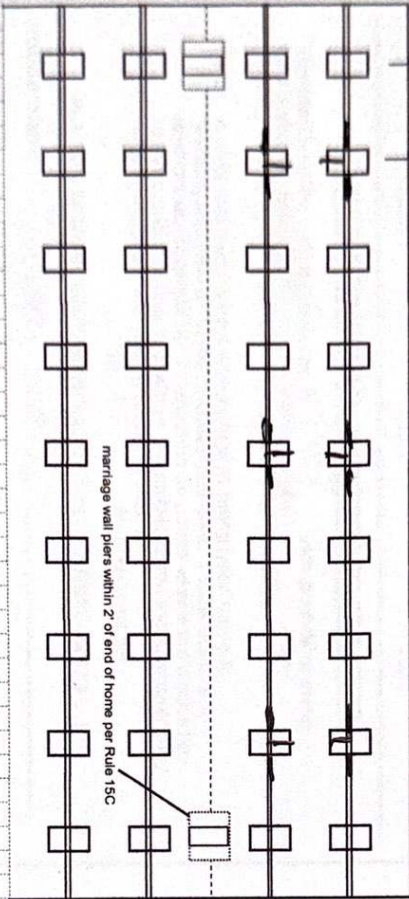

marriage wall piers within 2' of end of home per Rule 15C

Application Number: _____ Date: _____

New Home Used Home

Home installed to the Manufacturer's Installation Manual
 Home is installed in accordance with Rule 15-C

Single wide Wind Zone II Wind Zone III

Double wide Installation Decal # 114995

Triple/Quad Serial # _____

PIER SPACING TABLE FOR USED HOMES

Load bearing capacity (sq in)	16" x 16" (256)	18 1/2" x 18 (342)	20" x 20" (400)	22" x 22" (484)	24" x 24" (576)	26" x 26" (676)
1000 psf	3'	4'	5'	6'	7'	8'
1500 psf	4'	5'	6'	7'	8'	8'
2000 psf	5'	6'	7'	8'	8'	8'
2500 psf	6'	7'	8'	8'	8'	8'
3000 psf	7'	8'	8'	8'	8'	8'
3500 psf	8'	8'	8'	8'	8'	8'

Interpolated from Rule 15C-1 pier spacing table.

PIER PAD SIZES

I-beam pier pad size: 17 x 25

Perimeter pier pad size: 16 x 16

Other pier pad sizes (required by the mfg.): _____

Draw the approximate locations of marriage wall openings 4 foot or greater. Use this symbol to show the piers.

List all marriage wall openings greater than 4 foot and their pier pad sizes below.

Opening: _____ Pier pad size: _____

POPULAR PAD SIZES

Pad Size	Sq In
16 x 16	256
16 x 18	288
18.5 x 18.5	342
16 x 22.5	360
17 x 22	374
13 1/4 x 26 1/4	348
20 x 20	400
17 3/16 x 25 3/16	441
17 1/2 x 25 1/2	446
24 x 24	576
26 x 26	676

ANCHORS

4 ft X 5 ft

FRAME TIES

within 2' of end of home spaced at 5' 4" oc

OTHER TIES

TIEDOWN COMPONENTS: 6

Longitudinal Stabilizing Device (LSD) 6

Manufacturer Oliver Technology

Longitudinal Stabilizing Device w/ Lateral Arms 6

Manufacturer Oliver Technology

Number 8

Side wall W/A

Longitudinal W/A

Marriage wall W/A

Shearwall W/A

Mobile Home Permit Worksheet

POCKET PENETROMETER TEST

The pocket penetrometer tests are rounded down to _____ psf or check here to declare 1000 lb. soil without testing.

X _____ X _____ X _____

POCKET PENETROMETER TESTING METHOD

1. Test the perimeter of the home at 6 locations.
2. Take the reading at the depth of the footer.
3. Using 500 lb. increments, take the lowest reading and round down to that increment.

X _____ X _____ X _____

TORQUE PROBE TEST

The results of the torque probe test is 285 inch pounds or check here if you are declaring 5 anchors without testing _____. A test showing 275 inch pounds or less will require 5 foot anchors.

Note: A state approved lateral arm system is being used and 4 ft. anchors are allowed at the sidewall locations. I understand 5 ft anchors are required at all centerline the points where the torque test reading is 275 or less and where the mobile home manufacturer may requires anchors with 4000lb holding capacity.
 _____ Installer's initials

ALL TESTS MUST BE PERFORMED BY A LICENSED INSTALLER

Installer Name Sacal Truvel
 Date Tested 9-9-24

Electrical

Connect electrical conductors between multi-wide units, but not to the main power source. This includes the bonding wire between multi-wide units. Pg. NA

Plumbing

Connect all sewer drains to an existing sewer tap or septic tank. Pg. 7D
 Connect all potable water supply piping to an existing water meter, water tap, or other independent water supply systems. Pg. 107

Application Number: _____ Date: _____

Site Preparation

Debris and organic material removed _____
 Water drainage: Natural _____ Swale _____ Pad Other _____

Fastening multi wide units

Floor: Type Fastener: _____ Length: _____ Spacing: _____
 Walls: Type Fastener: _____ Length: _____ Spacing: _____
 Roof: Type Fastener: _____ Length: _____ Spacing: _____
 For used homes a min. 30 gauge, 8" wide, galvanized metal strip will be centered over the peak of the roof and fastened with galv. roofing nails at 2" on center on both sides of the centerline.

Gasket (weatherproofing requirement)

I understand a properly installed gasket is a requirement of all new and used homes and that condensation, mold, mildew and buckled marriage walls are a result of a poorly installed or no gasket being installed. I understand a strip of tape will not serve as a gasket.
 Installer's initials ST

Type gasket Pg. NA
 Installed: Between Floors Yes _____
 Between Walls Yes _____
 Bottom of ridgebeam Yes _____

Weatherproofing

The bottomboard will be repaired and/or taped. Yes Pg. 119
 Siding on units is installed to manufacturer's specifications. Yes
 Fireplace chimney installed so as not to allow intrusion of rain water. Yes

Miscellaneous

Skirting to be installed. Yes No _____
 Dryer Vent installed outside of skirting. Yes _____ N/A
 Range downflow vent installed outside of skirting. Yes _____ N/A
 Drain lines supported at 4 foot intervals. Yes
 Electrical crossovers protected. Yes
 Other: _____

Installer verifies all information given with this permit worksheet is accurate and true based on the manufacturer's installation instructions and or Rule 15C-1 & 2

Installer Signature Sacal Truvel Date 9-9-24

License Number: IH / 1148380 / 1 Name: JACOB T. TROWELL

Order #: 6391	Label #: 114995	Manufacturer:	(Check Size of Home)
Homeowner: <i>Terry Leslie</i>		Year Model:	Single _____
Address:		Length & Width:	Double _____
			Triple _____
City/State/Zip:		Type Longitudinal System:	HUD Label #:
Phone #:		Type Lateral Arm System:	Soil Bearing / PSF:
Date Installed:		New Home: _____ Used Home: _____	Torque Probe / in-lbs:
Installed Wind Zone:		Data Plate Wind Zone:	Permit #:
Note:			

STATE OF FLORIDA
INSTALLATION CERTIFICATION LABEL

114995

LABEL #

DATE OF INSTALLATION

JACOB T. TROWELL

NAME

IH / 1148380 / 1

6391

LICENSE #

ORDER #

CERTIFIES THAT THE INSTALLATION OF THIS MOBILE HOME IS
IN ACCORDANCE WITH FLORIDA STATUTES 320.8249, 320.8325
AND RULES OF THE HIGHWAY SAFETY AND MOTOR VEHICLES.

INSTRUCTIONS

PLEASE WRITE DATE OF
INSTALLATION AND AFFIX
LABEL NEXT TO HUD LABEL.
USE PERMANENT INK PEN
OR MARKER ONLY.
COMPLETE INFORMATION
ABOVE AND KEEP ON FILE
FOR A MINIMUM OF 2 YEARS.
YOU ARE REQUIRED TO
PROVIDE COPIES WHEN
REQUESTED.

OLIVER

Technologies, Inc.

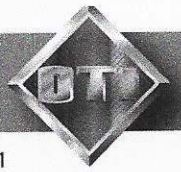

467 Swan Ave • Hohenwald, TN 38462 • (800) 284-7437 • www.olivertechnologies.com • Fax (931) 796-8811

**OLIVER TECHNOLOGIES, INC.
INSTALLATION INSTRUCTIONS FOR FLORIDA
MODEL 1101 "V" SERIES ALL STEEL FOUNDATION SYSTEM PAN & CONCRETE (revision 5/18)
PATENT# 6634150 & OTHER PATENT PENDING**

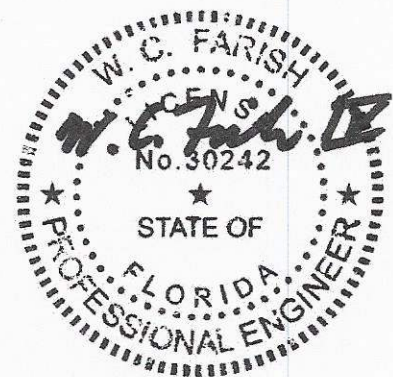

Aug 24, 2018



**OLIVER TECHNOLOGIES, INC.
FLORIDA INSTALLATION INSTRUCTIONS FOR THE
MODEL 1101 "V" SERIES ALL STEEL FOUNDATION SYSTEM**

**MODEL 1101"V" (Steps 1-14)
LONGITUDINAL ONLY: Follow Steps 1-9
LATERAL ONLY: Follow Steps 1-3 and Steps 10-14
FOR CONCRETE APPLICATIONS: Follow Steps 15-18**

ENGINEERS STAMP

ENGINEERS STAMP

1. SPECIAL CIRCUMSTANCES: If the following conditions occur - **STOP! Contact Oliver Technologies at 1-800-284-7437 :**

- a) Pier height exceeds 48"
- b) length of home exceeds 76'
- c) Roof eaves exceed 16"
- d) Sidewall height exceed 96"
- e) Location is within 1500 feet of coast

INSTALLATION OF GROUND PAN

2. Remove weeds and debris in an approximate two foot square to expose firm soil for each ground pan (C) .
3. Place ground pan (C) directly below chassis I-beam. Press or drive pan firmly into soil until flush or below soil then install pier per manufacturer's instructions or per Florida Regs.
SPECIAL NOTE: The longitudinal "V" brace system may also serve as a pier under the home and should be loaded as any other pier. It is recommended that after leveling piers, and one-third inch (1/3") before home is lowered completely on to piers, complete steps 4 through 9 below then remove jacks.

INSTALLATION OF LONGITUDINAL "V" BRACE SYSTEM (Model 1101 L "V")

NOTE: WHEN INSTALLING THE LONGITUDINAL SYSTEM ONLY, A MINIMUM OF 2 SYSTEMS PER FLOOR SECTION IS REQUIRED. SOIL TEST PROBE SHOULD BE USED TO DETERMINE CORRECT TYPE OF ANCHOR PER SOIL CLASSIFICATION. IF PROBE TEST READINGS ARE BETWEEN 175 & 275 A 5 FOOT ANCHOR MUST BE USED. IF PROBE TEST READINGS ARE BETWEEN 276 & 350 A 4 FOOT ANCHOR MAY BE USED. USE GROUND ANCHORS WITH DIAGONAL TIES AND STABILIZER PLATES EVERY 5'4" . VERTICAL TIES ARE ALSO REQUIRED ON HOMES SUPPLIED WITH VERTICAL TIE CONNECTION POINTS (PER FLORIDA REG.).

4. Choose one of the approved longitudinal tube installations; either Diagram A or B. Then select the correct square tube (E) length from the diagram for appropriate pier height at support location or cut and drill 1.5" square tube to achieve appropriate length.

PIER HEIGHT (40° Min. - 45° Max.)	1.25" Tube Length	1.50" Tube Length
7 3/4" to 25"	22"	18"
24 3/4" to 32 1/4"	32"	18"
33" to 41"	44"	18"
40" to 48"	54"	18"

Diagram A

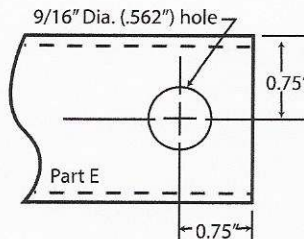

PIER HEIGHT (40° Min. - 60° Max.)	1.50" Tube Length
14" to 18"	20"
18" to 25"	28"
24" to 35"	39"
30" to 40"	44"
36" to 48"	54"

Diagram B

5. Install (2) of the 1.50" square tubes (E) into the "U" bracket (J), insert carriage bolt and leave nut loose for final adjustment.
6. Place I-beam connector (F) loosely on the bottom flange of the I-beam.
7. (For Diagram A installation) Slide the selected 1.25" tube (E) into a 1.50" tube (E) and attach to I-beam connectors (F) and fasten loosely with bolt and nut. (For Diagram B installation) Attach the selected 1.5" tubes (E) to the I-beam connectors (F) and fasten loosely with bolts and nuts.
8. Repeat steps 6 through 7 to create the "V" pattern of the square tubes loosely in place.
9. Using standard hand tools tighten all nuts and bolts. (For Diagram A installation only, secure 1.25" and 1.50" tubes using four (4) 1/4"-14 x 3/4" self-tapping screws in pre-drilled holes.)

INSTALLATION OF LATERAL TELESCOPING TRANSVERSE ARM SYSTEM (Model 1101 T "V")

THE MODEL 1101 "V" (LONGITUDINAL & LATERAL PROTECTION) ELIMINATES THE NEED FOR STABILIZER PLATES & FRAME TIES.

NOTE: THE USE OF THIS SYSTEM REQUIRES VERTICAL TIES SPACED AT 5'4".

FOUR FOOT (4') GROUND ANCHOR MAY BE USED EXCEPT WHERE THE HOME MANUFACTURER SPECIFIES DIFFERENT.

10. Install remaining vertical tie-down straps and 4' ground anchors per home manufacturer's instructions. NOTE: Centerline anchors to be sized according to soil torque condition. Any manufacturer's specifications for sidewall anchor loads in excess of 4,000 lbs. require a 5' anchor per Florida Code.
11. Select the correct square tube brace (H) length for set-up lateral transverse at support location. The lengths come in either 60" or 72" lengths. (With the 1.50" tube as the bottom tube, and the 1.25" tube as the inserted tube.)
12. Install the 1.50 transverse brace (H) to the ground pan connector (D) with bolt and nut.
13. Slide 1.25" transverse brace into the 1.50" brace and attach to adjacent I-beam connector (I) with bolt and nut.
14. Secure 1.50" transverse arm to 1.25" transverse arm using four (4) 1/4" - 14 x 3/4" self-tapping screws in pre-drilled holes.



INSTALLATION USING CONCRETE RUNNER/ FOOTER

15. A concrete runner, footer or slab may be used in place of the steel ground pan.
- The concrete shall be minimum 2500 psi mix
 - A concrete runner may be either longitudinal or transverse, and must be a minimum of 8" deep with a minimum width of 16 inches longitudinally or 18 inches transverse to allow proper distance between the concrete bolt and the edge of the concrete (see below).
 - Footers must have minimum surface area of 441 sq. in. (i.e. 21" square), and must be a minimum of 8" deep.
 - If a full slab is used, the depth must be a 4" minimum. Special inspection of the system bracket installation is not required. Footers must allow for at least 4" from the concrete bolt to the edge of the concrete.

NOTE: The bottom of all footings, pads, slabs and runners must be per local jurisdiction.



LONGITUDINAL: (Model 1101 LC "V")

16. When using Part# 1101-W-CPCA (wetset) simply install the bracket in runner/footer **OR** When installing in cured concrete use Part# 101-D-CPCA (dryset). The 1101 (dryset) CA bracket is attached to the concrete using (2) 5/8"x3" concrete wedge bolts (Simpson part # S162300H 5/8" X 3" or Powers equivalent). Place the CA bracket in desired location. Mark bolt hole locations, then using a 5/8" diameter masonry bit, drill a hole to a minimum depth of 3". Make sure all dust and concrete is blown out of the holes. Place wedge bolts into drill holes, then place 1101 (dry set) CA bracket onto wedge bolts and start wedge bolt nuts. Take a hammer and lightly drive the wedge bolt down by hitting the nut (making sure not to hit the top of threads on bolt). The sleeve of concrete wedge bolt needs to be at or below the top of concrete. Complete by tightening nuts.

LATERAL: (Model 1101 TC "V")

17. For wet set (part # 1101-W-TACA) installation simply install the anchor bolt into runner/footer. For dry set installation (part # 1101-D-TAC) mark bolt hole locations, then using a 5/8" diam. masonry bit. drill a hole to a minimum depth of 3". Make sure all dust and concrete is blown out of the hole. Place wedge bolts (Simpson part #S162300H 5/8" X 3" or Powers equivalent) into (D) concrete dry transverse connector and into drilled hole. If needed, take a hammer and lightly drive the wedge bolts down by hitting the nut (making sure not to hit the top of threads on bolt), then remove the nut. The sleeve of concrete wedge bolt needs to be at or below the top of concrete.
18. When using part# 1101 CVW (wetset) or 1101 CVD (dryset), install per steps 17 & 18.

Notes:

- LENGTH OF HOUSE IS THE ACTUAL BOX SIZE**
-  = **LOCATION OF TRANSVERSE BRACING ONLY**
-  = **LOCATION OF LONGITUDINAL BRACING ONLY**
-  = **TRANSVERSE AND LONGITUDINAL LOCATIONS**

ALL WIDTHS AND LENGTHS UP TO 52'

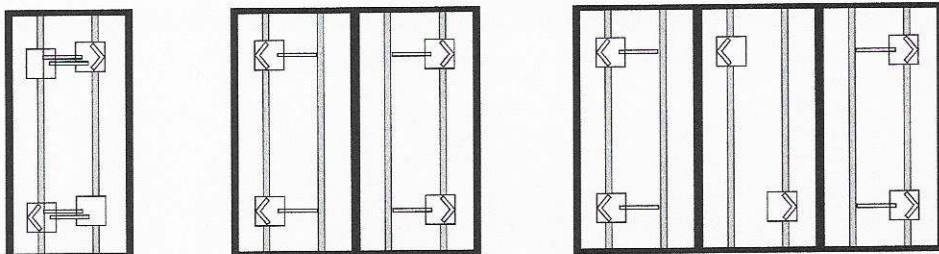

ALL WIDTHS AND LENGTHS OVER 52' TO 80"

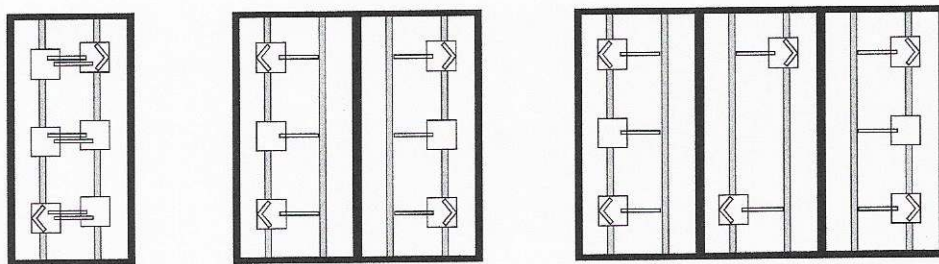

HOMES WITH 5/12 ROOF PITCH REQUIRE: PER FLORIDA REGULATIONS
6 systems for home lengths up to 52' and 8 systems for homes over 52' and up 80'

PATENT# 6634150 & OTHER PATENT PENDING

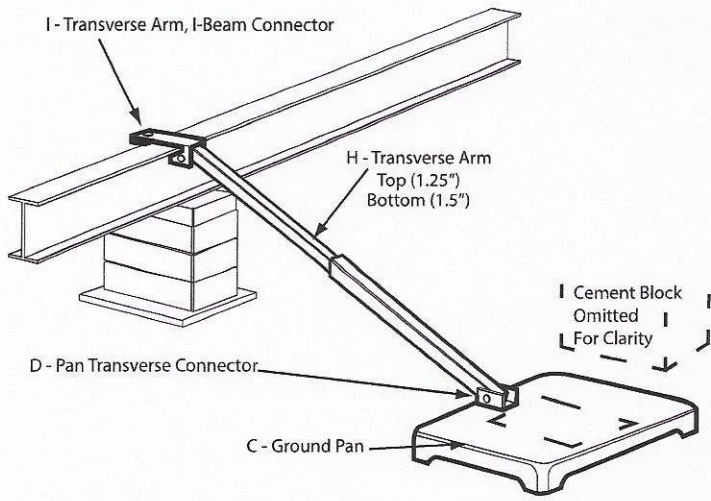

Model # 1101 T "V"

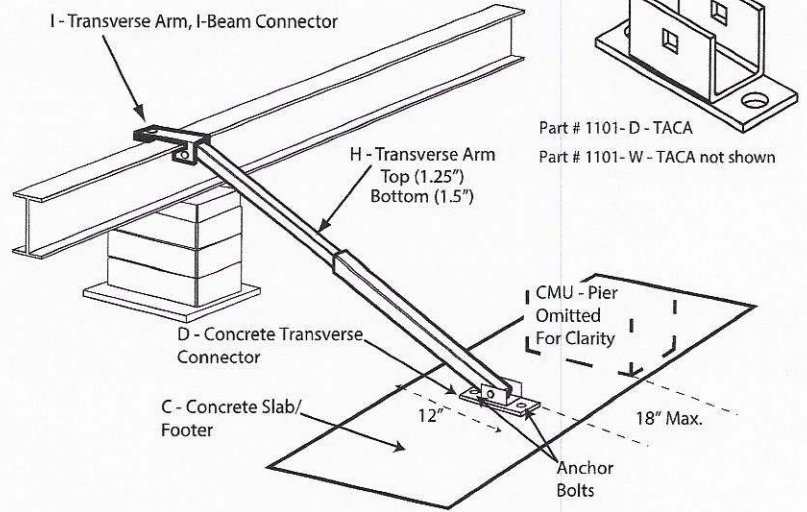

Model # 1101 TC "V"

Florida approved 4' ground anchors may be used in all locations except where home manufacturers specifications for sidewall straps are in excess of 4,000 lbs. These locations require a 5' anchor. Per Florida code.

C = GROUND PAN / CONCRETE FOOTER OR RUNNER

D = GROUND PAN / CONCRETE U BRACKETS TRANSVERSE CONNECTOR (connects with grade 5 - 1/2" x 2" 1/2" carriage bolt and nut)

E = TELESCOPING V BRACE TUBE ASSEMBLY (1.5" TUBE BOTTOM AND 1.25" TUBE INSERT) OR 1.5" TUBE

F = "V" BRACE I-BEAM CONNECTOR ASSEMBLY

H = TELESCOPING TRANSVERSE ARM ASSEMBLY

I = TRANSVERSE ARM I-BEAM CONNECTOR (connects with grade 5 - 1/2" x 2" 1/2" carriage bolt and nut)

J = V PAN BRACKET (connects with grade 5 - 1/2" x 2" 1/2" carriage bolt and nut)

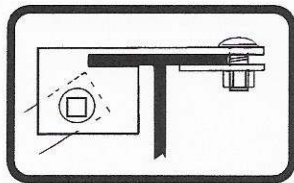

I - Transverse Arm, I-Beam Connector

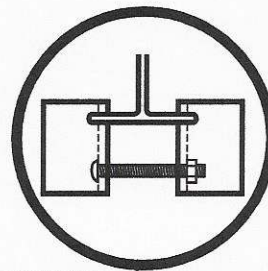

F - "V" Brace I-Beam Connectors

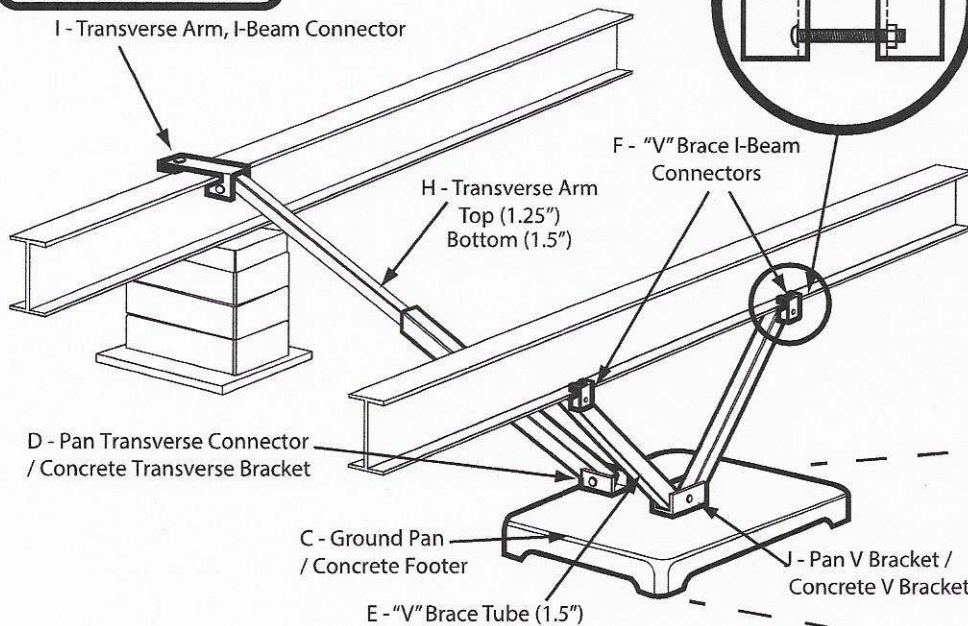

Model # 1101 "V"

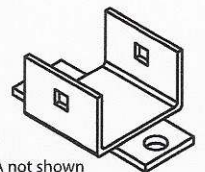

Part# 1101 D-CPCA
Part # 1101 W-CPCA not shown

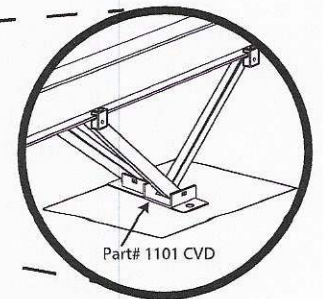

Part# 1101 CVD

Model # 1101 C "V"



State of Florida
**DEPARTMENT OF
HIGHWAY SAFETY AND MOTOR VEHICLES**

TALLAHASSEE, FLORIDA 32399-0500

FRED O. DICKINSON, III
Executive Director

October 27, 1999

Mr. Lon Larson, General Manager
Manufactured Housing Foundation Systems
A Division of Oliver Technologies
562 Glenheather Drive
San Marcos, California 92069

Dear Mr. Larson:

We wish to acknowledge receipt of your print specifications and test results certifying your Adjustable Outrigger listed below complies with the Federal Manufactured Construction and Safety Standards, § 3280.305 and § 3280.401 and with the rules and regulations set forth by the Department of Highway Safety and Motor Vehicles, Florida Administrative Rule Code 15C-1.01105.

Based on the information submitted to the bureau, the following product is listed for use in Florida when the installation instructions showing the way the outrigger was tested, are provided.

MODEL #	IDENTIFICATION	DESCRIPTION
1055-11	Adjustable Outrigger	Bracket, Pipe, & Screw Adjustment

NOTE: The outrigger was tested on September 19, 1999, for an allowable load of 1700 pounds.

If you have any questions, please advise at (850) 413-7600.

Sincerely,

Phil Bergelt, Program Manager
Bureau of Mobile Home and
Recreational Vehicle Construction
Division of Motor Vehicles

PB:bsc



OLIVER TECHNOLOGIES, INC.
Adjustable Outrigger Installation Instructions
MODEL # 1055-11

1. Locate the floor joist that requires support.
2. Mark the I-Beam directly under the floor joist to align the outrigger.
3. Adjust the nut on the threaded rod so it clears the frame flange for easy adjustment.
4. Set the threaded rod in the pipe and against the frame.
5. Set the notched end of the thrust bracket into the end of the pipe and secure it with 5 # 12 x 2" screws to the floor joist. The thrust bracket should be approximately 6" from the outside rim joist.
6. Bottom board and insulation should be between the bracket and the joist.
7. For minor adjustments align the door and window openings by tightening or loosening the adjustment nut. For all other adjustments use a hydraulic jack to raise the floor joist before installation of the outrigger.

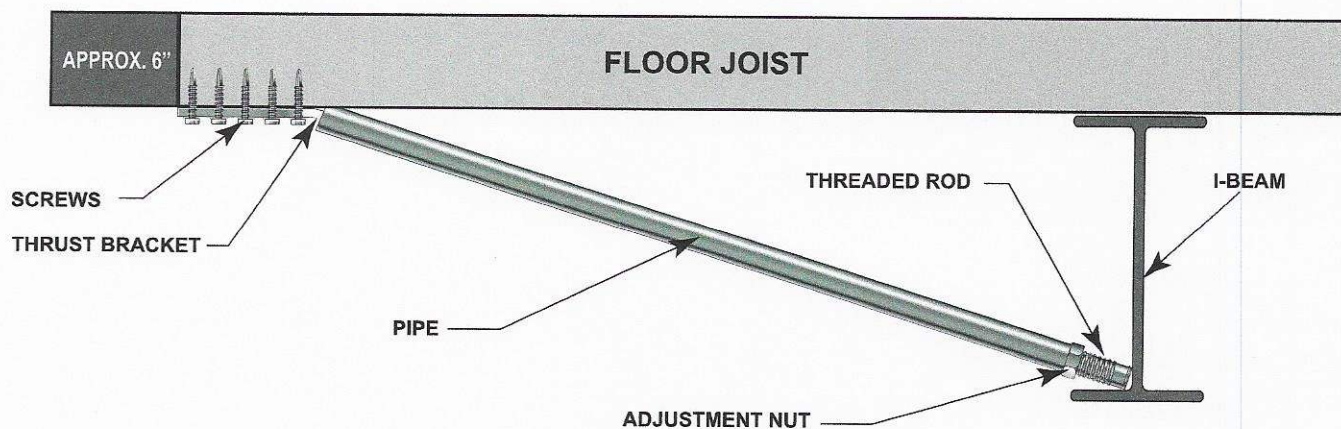
**NOTES:**

*REMOVE OUTRIGGER WHEN HOME IS BEING TRANSPORTED

*SPECIFY WIDTH OF HOME WHEN ORDERING OUTRIGGER. PIPE MAY BE CUT TO FIT

*THE ADJUSTABLE OUTRIGGERS SHALL ONLY BE USED ON HOMES FOR OPENINGS UP TO:

6' ON 20 LB ROOF LOAD

4' ON 30 LB ROOF LOAD

3' ON 40 LB ROOF LOAD

*WHEN ADJUSTABLE OUTRIGGERS ARE USED FOR DOOR AND WINDOW SUPPORTS, THEY MUST BE INSTALLED ON THE CLOSEST FLOOR JOIST UP TO 16" FROM THE OUTSIDE EDGE OF THE OPENING

*DO NOT INSTALL ADJUSTABLE OUTRIGGER AT LOCATIONS WHERE THE HOME MANUFACTURER INDICATES A LOAD IN EXCESS OF 1,700 LBS.

*THE ADJUSTABLE OUTRIGGER MUST BE USED ON A MINIMUM 10" I-BEAM AND BE PLACED WITHIN 4' OF A MAIN FRAME SUPPORT PIER OR FRAME CROSSMEMBER.

Listing # 1055-11

Patent # 6.334.279

VERTICAL VINYL SKIRTING

THE MANUFACTURER'S INSTRUCTIONS & DESIGNERS DO NOT ALLOW FOR PLACING SCREWS IN THE TOP & BOTTOM OF EACH PANEL..... THIS WILL VOID WARRANTY

THERE WILL BE TWO PANELS ON THE JOB SITE SECURE WITH PHILIPS HEAD SCREWS DENING THEM ACCESS PANELS

THE MANUFACTURER INTEGRATED VENTING IN EACH PANEL (EQUIVLENT TO 16.5 SQUARE INCHES PER LINEAR FOOT OF PANEL)

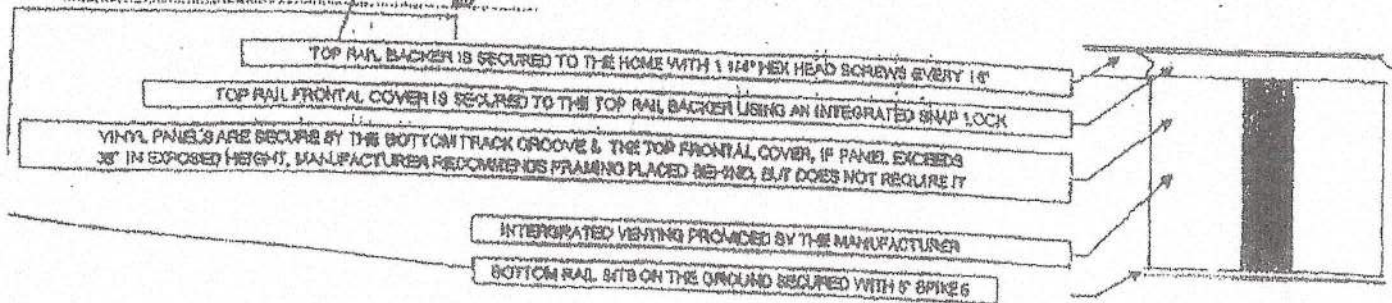

STAIR DETAIL

2023 FLORIDA BUILDING CODE 8TH EDITION.
RESIDENTIAL SECTIONS R311 AND 312.

- R311.7.2 HEADROOM
- R311.7.5 RISER HEIGHT
- R311.7.5.2 TREAD DEPTH
- R311.7.8.2 HANDRAILS
- R311.7.8.3 CONTINUITY
- R311.7.8 HANDRAIL GRIP SIZE
- R312.1.2 -GUARDS
- R312.1.3 GUARD OPENING LIMITS

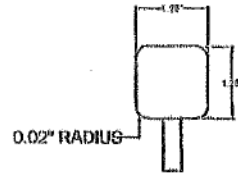

HANDRAIL THAT IS NOT CIRCULAR MUST HAVE A PERIMETER OF 4.0' MIN AND 6.25' MAX WITH A CROSS SECTION DIMENSION OF 2.25'

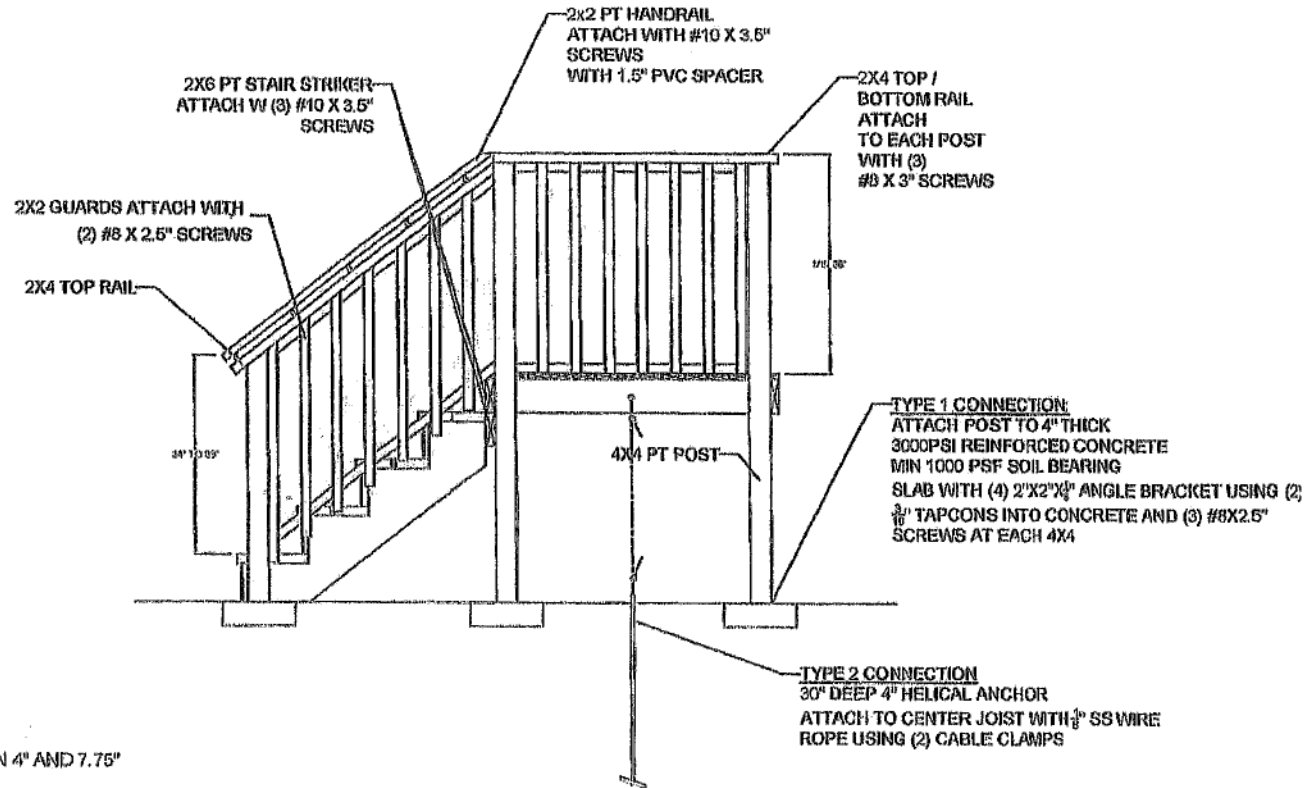

NOTES:

- STEP HAS A MIN 40"X40" LANDING
- STEP HAS A RISER HEIGHT OF BETWEEN 4" AND 7.75"
- HANDRAIL HEIGHT 36"
- 2"X2" HANDRAIL " RADIUS ALL SIDES
- GUARDRAIL TO BE 36"
- OPENING WILL REJECT 4" SPHERE

**TYPICAL HANDRAIL
CONSTRUCTION DETAILS**

INSTALLATION VERTICAL SKIRTING (WALL SECTION)

1. Top back rail will be screwed to bottom of home with 3/4" screw every 16".
2. Bottom track will be spiked every 16" with 7" galvanized nail.
3. Each panel must be installed with required screws. Screws installed in each panel top and bottom every 16".
4. Access allowed by any panel.
5. Any part of home over 36" from bottom of home to ground will require metal bracing with cross brace. (Bracing requirements 2 x 3 metal brace attached to bottom of home with 3/4" screws and buried in the ground every 4' with cross brace.)

