

General Notes



General

The swimming pools and spas consist of one-piece fiberglass construction shop-formed over a mold. The material is fiberglass reinforced plastic (FRP), a minimum of 1/4 inch (6.4 mm) thick, composed of isophthalic resin, vinyl ester resin, and fiberglass. The surface finish is a neo pentyl glycol gel coat. Viking Pools produces various styles of swimming pools and spas. When installed in accordance to Viking Pools installation procedures, the pools and spas comply with applicable requirements of the following codes:

- 2018/2021 International Building Code® (IBC)
- 2018/2021 International Residential Code (IRC)
- 2018/2021 International Plumbing Code® (IPC)
- 2018/2021 IAPMO Uniform Plumbing Code (IAPMO UPC)
- 1997 Uniform Building Code (UBC)
- BOCA® National Building Code/2003 (BNBC)

- 2023 Florida Building Code 8th Edition
- 2023 Florida Plumbing Code 8th Edition
- 2023 Florida Fuel/Gas Code 8th Edition
- 2023 Florida Mechanical Code 8th Edition
- 2023 Florida Residential Code 8th Edition
- 2020 National Electric Code (NEC)

- 2007 ANSI/ASME-A112.19.8
- 2014 (R2023) ANSI/APSP/ICC-3 Permanently Installed Residential Spas and Swim Spas
- 2011 (R2022) ANSI/NSPI-5 Residential Inground Swimming Pools
- 2020 ANSI/APSP/ICC-7 Suction Entrapment Avoidance
- 2017 (PA2021) ANSI/APSP/ICC-16 Suction Outlet Fitting Assemblies
- 2024 International Swimming Pool and Spa Code - (ISPSC-ICC)
- 2024 Uniform Swimming Pool, Spa, Hot tub Code (IAPMO)

The overall pool dimensions, depths and capacities are shown in Table 1. The units comply with ANSI/NSPI-5, specified in Section AG103.1 of the IRC, and IAPMO IGC-2000*, specified in the UPC. Models described in Table 2 and Table 3 can be placed up to 19-1/2 inches (49.5mm) above ground. These pools and spas may be placed with or without concrete or wood decking. Unless elevated portions of the units are protected from sunlight by soil berms, decking, etc., these portions must be coated with a UV-inhibiting opaque paint that is compatible with the laminate.

All plumbing and electrical work must comply with the referenced codes in effect at the construction site. The pool and spa must remain full of water at all times. A permanent sign, bearing the following statement, must be attached to the pumping equipment:

Notice-The pool or spa is designed to remain full of water at all times. The pool shell may be damaged if the water level is allowed to drop below the skimmer. When appreciable draw-down is noticed or if it becomes necessary to drain the pool or spa, contact Viking Pools or its dealers for instructions.

A permanent label must be installed adjacent to the above sign indicating the Viking Pools dealer's name, address and telephone number.

Installation Procedure:

Viking pools and spas may be installed without a soil investigation by a registered design professional(RDP), subject to the building official's approval, provided none of the following conditions are encountered at the site:

1. The existence of uncontrollable groundwater within the depth of the pool or spa excavation.
2. The existence of an uncompacted fill in contact with any portion of the pool or spa.
3. The existence of any soil types with an angle of repose that will not support the walls of the excavation at desired slopes.
4. Danger to adjacent structures posed by the proposed pool or spa location
5. The existence of any cracks or openings in soil that would not confine sand or 1/2" clean gravel bedding.

If any of the conditions above is encountered, excavation must cease immediately. The specified conditions at the site must then be reviewed and recommendations made by the RDP. The building official must approve the RDP's report before work is completed.

The pool or spa excavation profile must coincide with the contours of the pool. The over excavation is minimum 6 inches (152mm) on the sides and ends. The over excavation at the pool bottom is minimum 4 inches (102mm). The backfill for the pool or spa bottom is a layer of 3-inch-thick (76mm) bedding sand matching the pool or spa profile.

This sand layer is compacted using a manual tamper and water. The pool or spa is then set into place using a crane, excavator or manually and be within 1 inch (25mm) of level. Simultaneous waterfill and sand backfill operations then commence. The sand is compacted with a tamper and water. The installer must ensure that the backfill level and water level are approximately the same throughout this procedure.

After completion of the backfill and plumbing, the decking is placed. Decks are prepared as indicated in Figures 1 though 4:

1. Cantilevered concrete decks are constructed as noted in Figure 1 in all cases.
2. Cantilevered decks are constructed with brick or stone as noted Figure 2 in all cases.
3. Raised bond beams are constructed as noted in Figure 3 in all cases.
4. Aboveground installations are constructed as noted in Figure 4 in all cases.

Barriers are required where pools are on premises of UBC Group R, Division 3, Occupancies or IBC Group R Occupancies. The barriers must comply with Appendix Chapter 4, Division 1, of the UBC or Section 3109.4 of the IBC and 2023 Florida Building Code, Residential, 8th Ed., Section R4501.17, R4501.17.1.1 through R4501.17.1.15

Expansive soils:

For installation of pools or spas in expansive soils, the following additional installation details must be followed subject to code official's approval:

1. All surfaces adjacent to the pool or spas must be excavated to a minimum depth of 12 inches (305 mm) beneath the pool bottom and minimum 6 inches (152 mm) behind the pool walls.
2. Any soft or loose soils exposed by step 1 must be removed until exposed material is solid. If the soil is still soft and loose, the upper 6 inches (152 mm) of all horizontal excavation surfaces must be scarified and compacted with mechanical equipment. The compacted surfaces and the excavated wall surfaces must be maintained in a moist condition until the first lift of backfill or fill is placed against the surface. The term compaction implies any method necessary to consolidate the native and fill materials to keep the pool or structure from settling.

3. The excavated bottom area of the pool or spa must be backfilled with granular import material to approximately 6 inches (152 mm) below the bottom of the pool or spa, wetted and compacted.
4. The remaining 6 inches (152 mm) must be backfilled beneath the pool or spa and outside the pool walls with compacted clean sand. The pool or spa must be filled with water as backfilling progresses to a level equivalent to that of the backfill. The backfill must be placed in compacted layers of approximately 6 inches (152 mm) while a uniform height of backfill is maintained around the pool or spa.
5. Positive surface drainage away from the perimeter of the pool and surrounding deck is required and critical to installations in highly expansive soils. Surface area drains and surface drainage swales or subdrains must be placed as needed to prevent ponding or saturation of the soil around the perimeter and vicinity of the pool to prevent excessive shrink-swell or volume changes in the soil.

Identification:

Viking pools and spas are identified by the following information imprinted on the top step of the pool or spa: manufacturer's name (Viking Pools) and address, pool or spa model designation, a coded serial number and the evaluation report number (ESR-2014).

The units also bear the label of the quality control agency, Columbia Research & Testing Corporation (AA-527).

Findings: That the fiberglass one piece swimming pools and spas are in compliance with the above listed codes as noted in ESR-2014 subject to the following conditions.

1. The construction and pool/spa installation comply with this report and the manufacturer's instructions.
2. Electrical and plumbing installation comply with the respective codes in effect at the construction site.
3. That all pools are installed in accordance with manufacturer's recommendations.
4. The pools and spas produced by Viking Pools Northeast, Inc. 176 Viking Drive Industrial Park, Jane Lew, West Virginia; Viking Pools Central, Inc., 10600 West Interstate 20 East, Midland, Texas; and Viking Pools, Inc., 121 Crawford Road, Williams, California; Viking Pools Southeast, 40119 Country Road 54E, Zephyrhills, FL are manufactured under a quality control program with inspections by Columbia Research & Testing Corporation (AA-527).

Length, width and depth may vary up to 3% - all dimensions are to outside edge of coping, measured from parallel lines.

This item has been digitally signed and sealed by Donald R. Poindexter, PE on the date adjacent to the seal. Printed copies of this document are not considered signed and sealed and the signature must be verified on any electronic copies.

NOTE: When installed in accordance with Viking Pools installation procedures, the pools and spas comply with applicable requirements of the 2023 Florida Building Code, Residential, 8th Edition, Section R4501, R4501.6 and R4501.6.1, including ANSI/APSP/ICC3, ANSI/APSP/ICC4, ANSI/APSP/ICC5, ANSI/APSP/ICC6 AND ANSI/APSP/ICC7.

The installation must comply with mandatory energy consumption requirements of Section R403.10, R403.10.1 through R403.10.3, Energy Consumption of Pools and Spas.



Page	Table of Contents	Content
C-001.....	General Notes	
C-002.....	Tables 1-3	
C-003.....	Figures 1-8	
C-004.....	Pool Models	
C-005.....	Pool Models	
C-006.....	Pool Models	
C-007.....	Spa Models - Tanning Ledges	
C-008.....	Alternative Recirculation Systems	

Reviewed by:

Donald R. Poindexter, PE
Florida Lic. No. 64901
4119 Trinity Dr Santa Rosa CA 95405
Phone 707-494-8761

Seal:

Project Name and Address

Tim Perrault
394 SW Sonoma Way
Fort White, FL 32038
Columbia County

Contractor: Paragon Pools
Model: Laguna Pool
Date: 01/12/2026
LP2191

Latham Pool Products Inc.
DBA Latham Grand, Latham Select
Viking Pool, Blue Hawaiian Pools, Trilogy Pools
ICC Evaluation Report Number (ESR-2014)

Latham, NY Phone: (800) 833-3600
Jane Lew, WV Phone: (304) 864-6954 Fax: (304) 864-7198
Midland, TX Phone: (432) 561-9933 Fax: (432) 561-9934
Williams, CA Phone: (530) 473-5319 Fax: (530) 473-5393
Zephyrhills, FL Phone: (813) 783-7439 Fax: (813) 783-7214

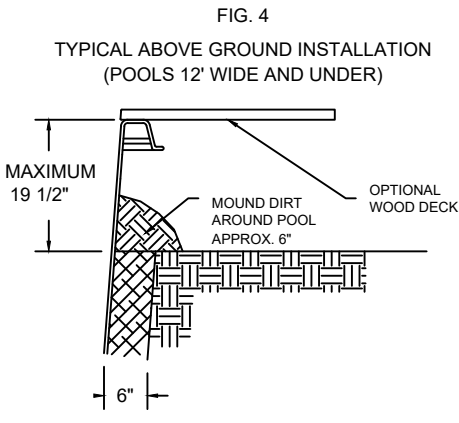
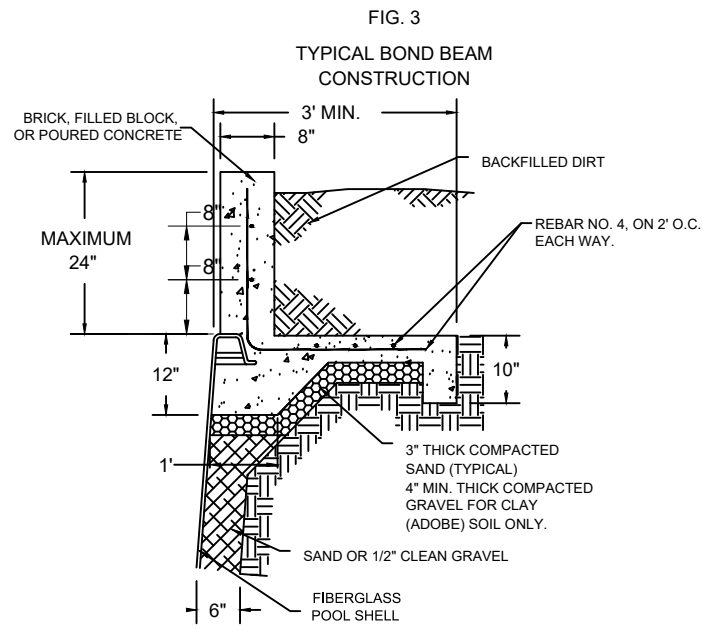
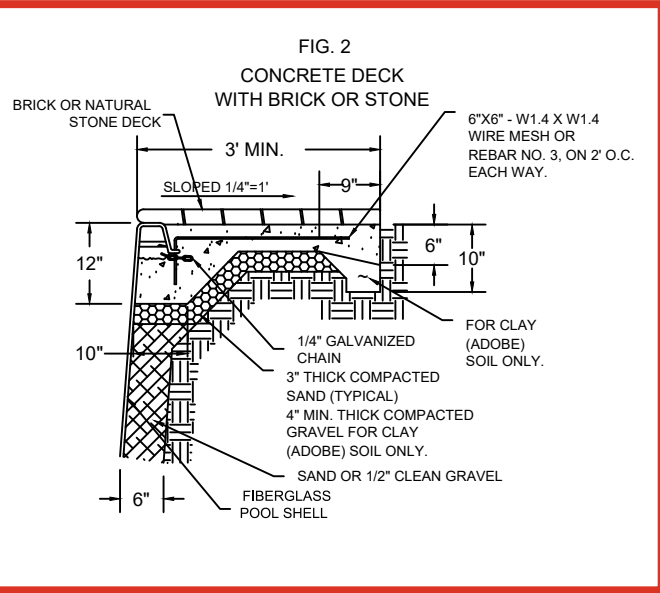
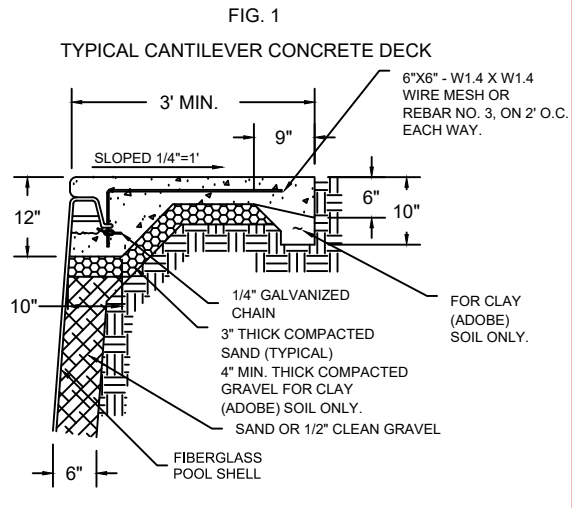

FIG. 5
TYPICAL BOND BEAM WITH SPA

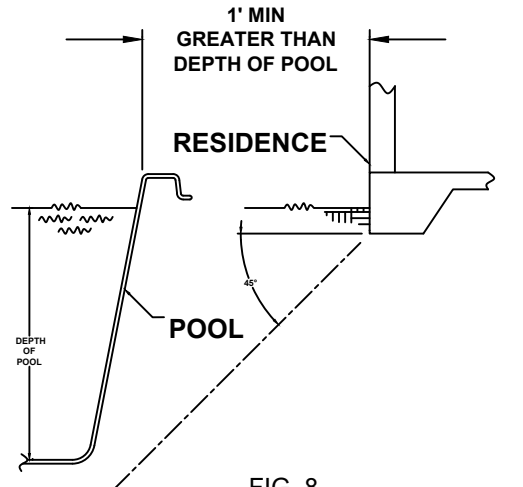
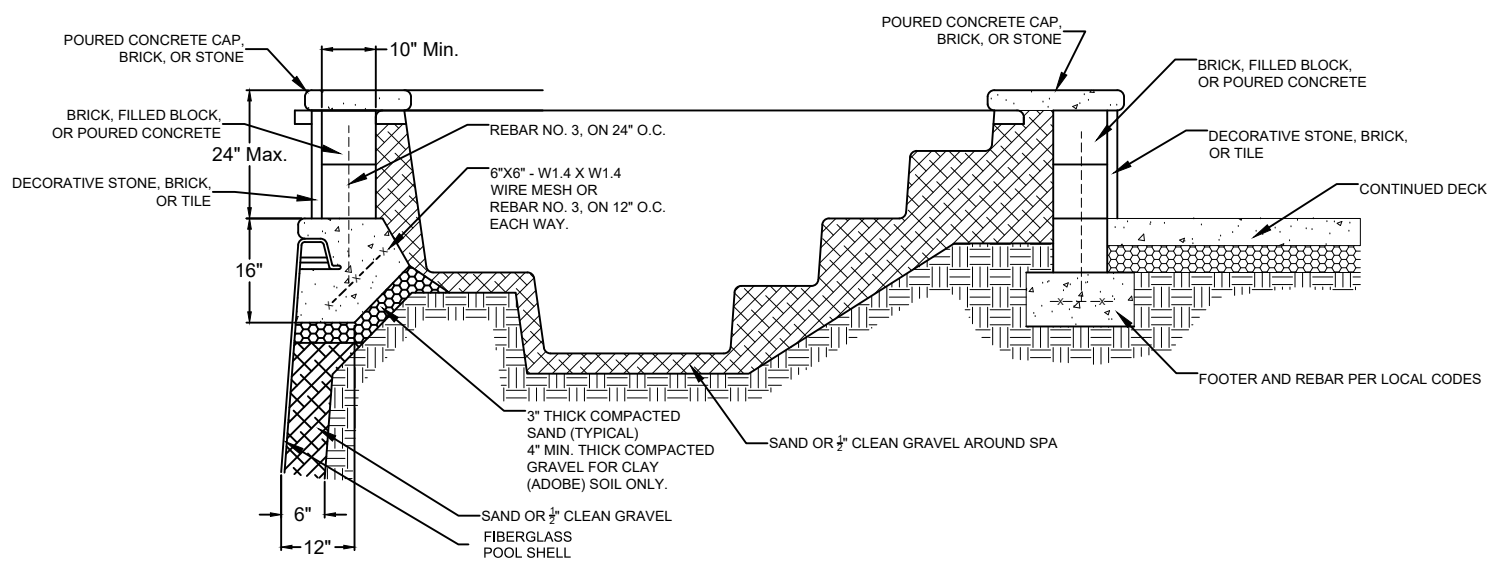
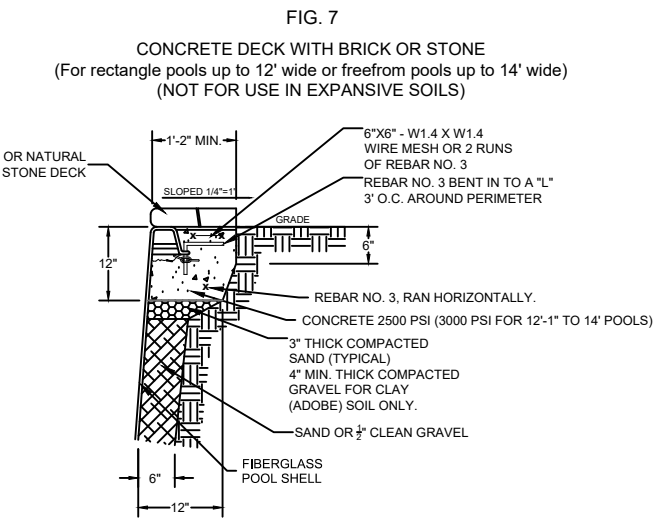
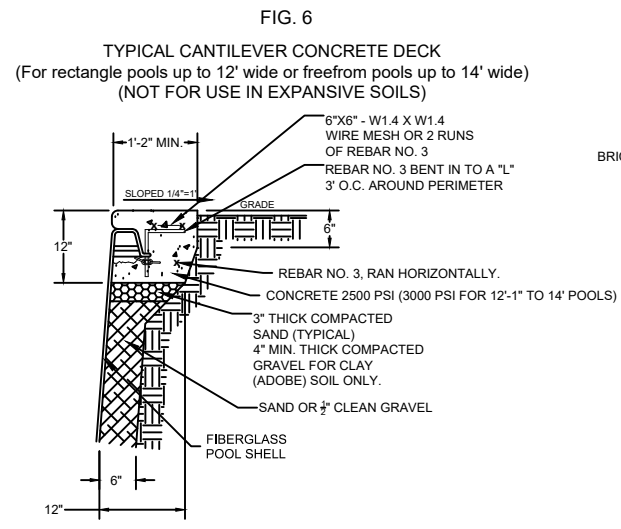

FIG. 8
ANGLE OF REPOSE
(NO INCREASED PRESSURE ON POOL WALLS FROM ADJACENT STRUCTURE)



NOTES

Latham Pool Products Inc.
 DBA Latham Grand, Latham Select
 Viking Pool, Blue Hawaiian Pools, Trilogy Pools
 ICC Evaluation Report Number (ESR-2014)

Latham, NY Phone: (800) 833-3800
 Jane Lew, WV Phone: (304) 884-6954 Fax: (304) 884-7198
 Midland, TX Phone: (432) 561-9933 Fax: (432) 561-9934
 Williams, CA Phone: (530) 473-5319 Fax: (530) 473-5393
 Zephyrhills, FL Phone: (813) 783-7439 Fax: (813) 783-7214

Reviewed by:
 Donald R. Poindexter, PE
 Florida Lic. No. 64901
 4119 Trinity Dr Santa Rosa CA 95405
 Phone 707-494-8761

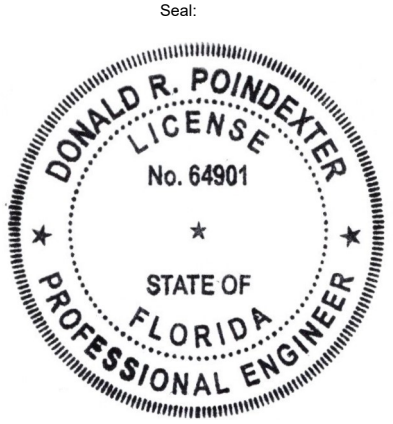

Length, width and depth may vary up to 3% - all dimensions are to outside edge of coping, measured from parallel lines.

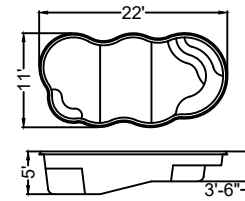

ARUBA - ARU
5,200 Gal. Approx.

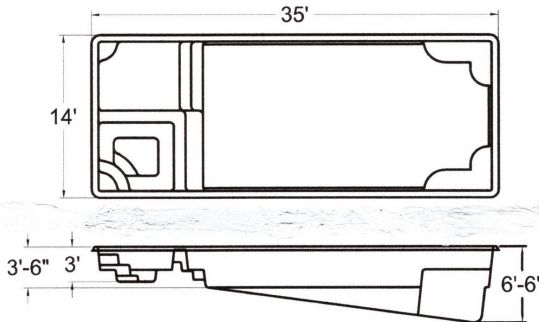

ASTORIA - FRX14
10,700 Gal. Approx.

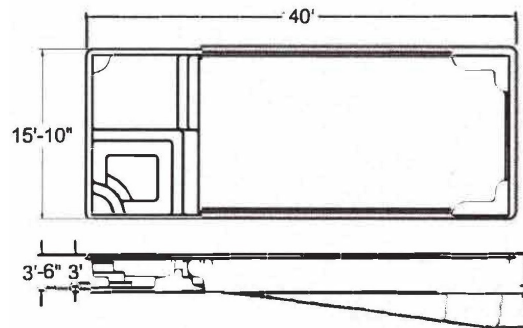

ASTORIA 16 - FRX
15,600 Gal. Approx.

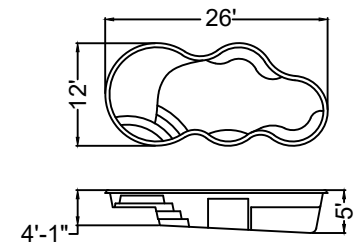

AXIOM 12/ECLIPSE - CRUM
5,300 gal. approx.

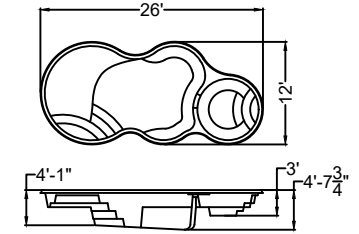

AXIOM 12 DELUXE/MALIBU - CRUD
4,400 Gal. Approx.

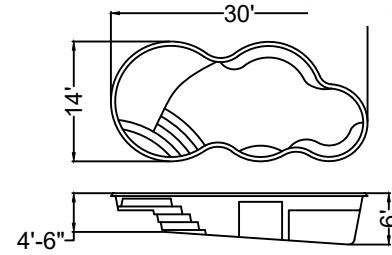

AXIOM 14/NEBULA - CRUL
8,000 gal. approx.

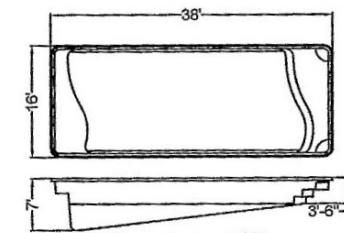

Barcelona - BAR
18,500 gal. approx.

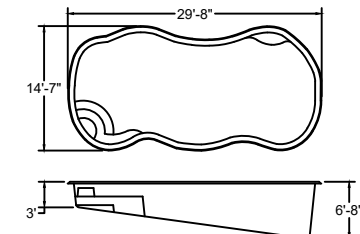

BAY ISLE - BHBY
10,000 Gal. Approx.

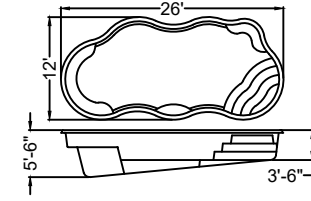

BERMUDA - AL
7,000 gal. approx.

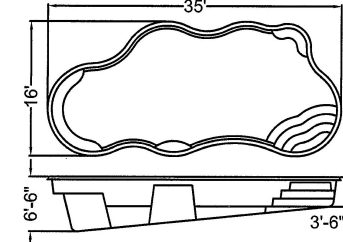

CANCUN - CC
14,000 gal. approx.

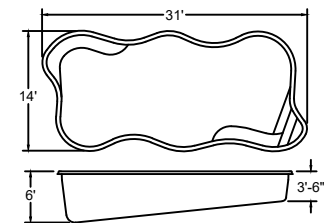

CAPE COD - CA
12,000 gal. approx.

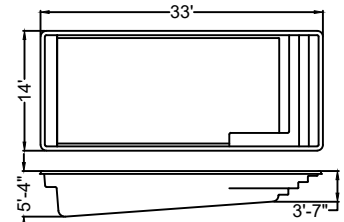

CLAREMONT - V
11,700 Gal. Approx.

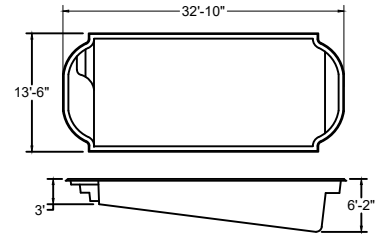

CLASSIC COVE - BHCC
11,300 Gal. Approx.

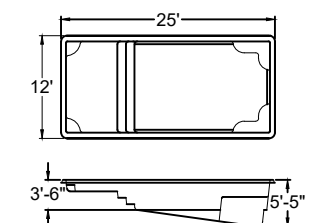

CORINTHIAN 12 - RT12
5,100 gal. approx.

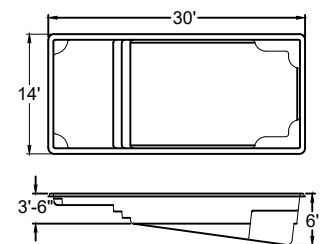

CORINTHIAN 14 - RT14
8,200 gal. approx.

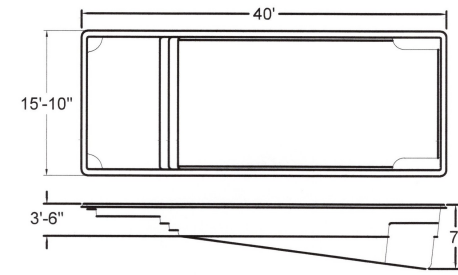

CORINTHIAN 16 - RT16
15,400 Gal. Approx.

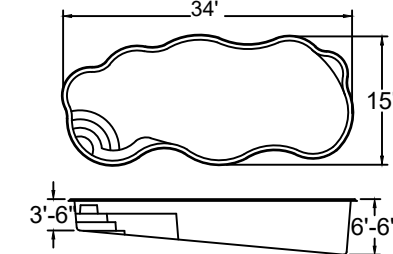

CORONADO - BHBI
13,000 Gal. Approx.

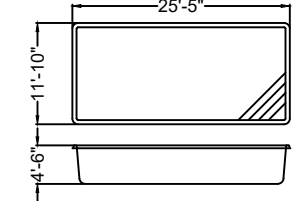

DELRAY - B
8,100 gal. approx.

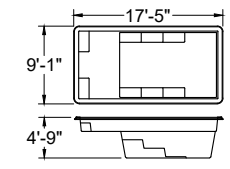

ENCHANTMENT 9.17 - NIV05
3,200 gal. approx.

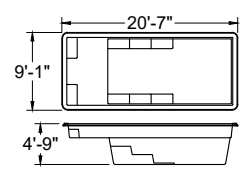

ENCHANTMENT 9.21 - NIV06
4,000 gal. approx.

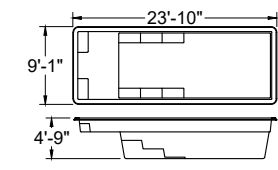

ENCHANTMENT 9.24 - NIV06
4,800 gal. approx.

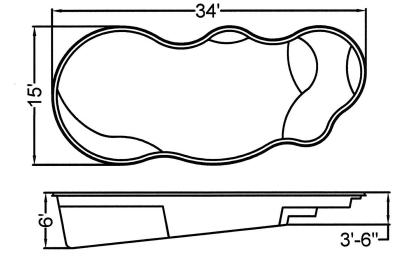

FIJI - FJI
12,000 gal. approx.

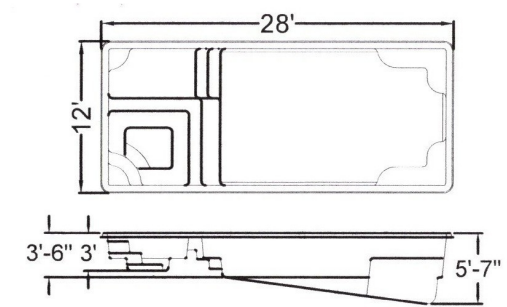

Model currently under review and not on the ICC ESR-2014 Report.

ASTORIA 12 - FRX12
6,000 Gal. Approx.

NOTES

Latham Pool Products Inc.
DBA Latham Grand, Latham Select
Viking Pool, Blue Hawaiian Pools, Trilogy Pools
ICC Evaluation Report Number (ESR-2014)

Latham, NY Phone: (800) 833-3800
Jane Lew, WV Phone: (304) 884-6954 Fax: (304) 884-7198
Midland, TX Phone: (432) 561-9933 Fax: (432) 561-9934
Williams, CA Phone: (530) 473-5319 Fax: (530) 473-5393
Zephyrhills, FL Phone: (813) 783-7439 Fax: (813) 783-7214

Reviewed by:
Donald R. Poindexter, PE
Florida Lic. No. 64901
4119 Trinity Dr Santa Rosa CA 95405
Phone 707-494-8761

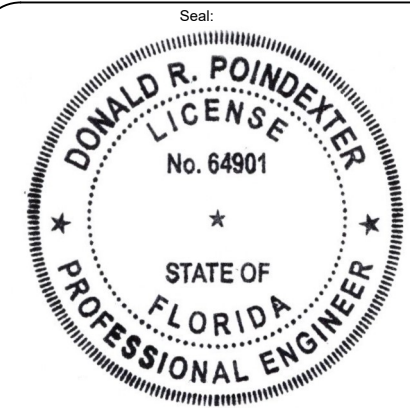

Length, width and depth may vary up to 3% - all dimensions are to outside edge of coping, measured from parallel lines.

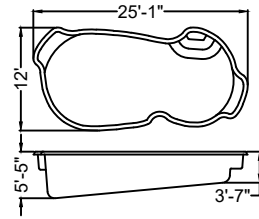

FREEPORT - FP
6,000 gal. approx.

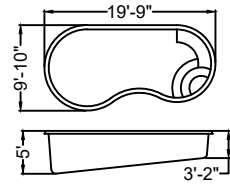

JAMAICA - LD
3,750 gal. approx.

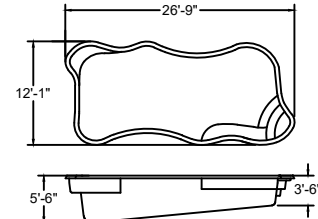

JAVA - JV
6,800 Gal. Approx.

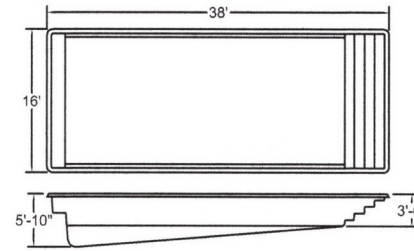

KINGSTON - AP
17,500 Gal. Approx.

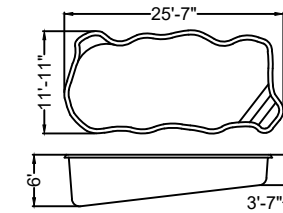

KEY WEST - BFF
9,000 gal. approx.

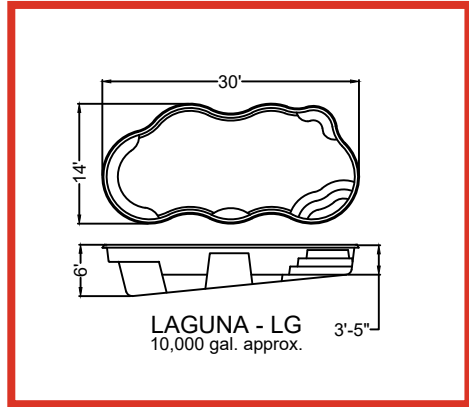

LAGUNA - LG
10,000 gal. approx.

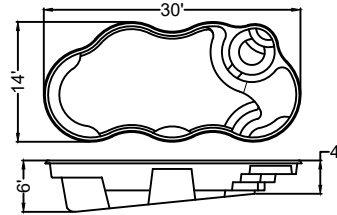

LAGUNA DELUXE - LGX
9,000 gal. approx.

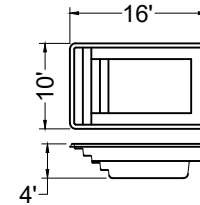

MILAN- CTL
2,450 gal. approx.

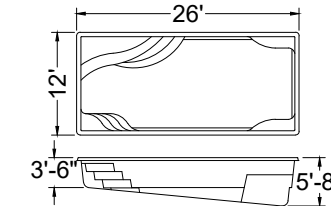

OLYMPIA 12/EMPRESS - FR12
7,600 gal. approx.

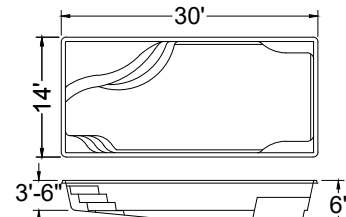

OLYMPIA 14/MAJESTY - FR14
11,200 gal. approx.

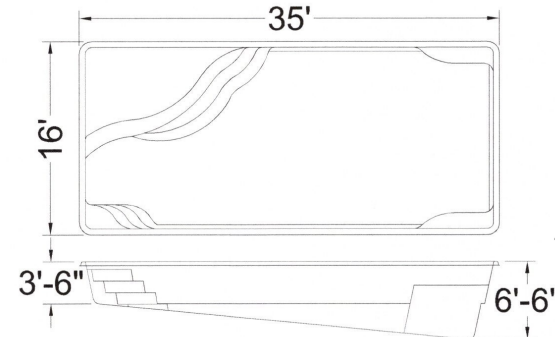

OLYMPIA - FR16
15,250 gal. approx.

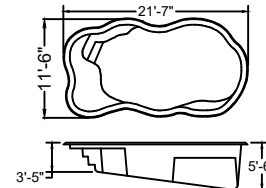

PLEASANT COVE - BHPL
5,000 Gal. Approx.

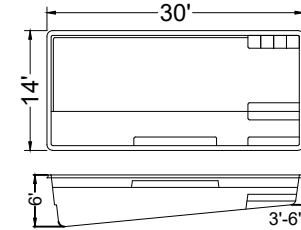

PROVIDENCE 14 - SE14
7,900 gal. approx.

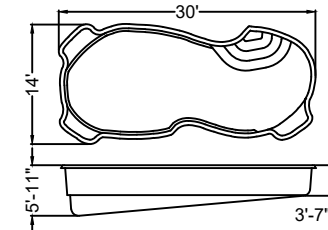

ROCKPORT - RP
12,800 gal. approx.

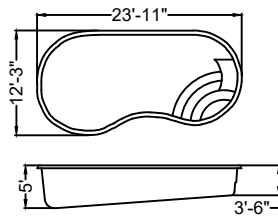

ST. LUCIA - CM
6,000 gal. approx.

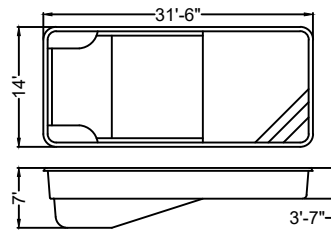

ST. THOMAS - L
13,700 gal. approx.

NOTES

Latham Pool Products Inc.
DBA Latham Grand, Latham Select
Viking Pool, Blue Hawaiian Pools, Trilogy Pools
ICC Evaluation Report Number (ESR-2014)

Latham, NY Phone: (800) 833-3800
Jane Lew, WV Phone: (304) 884-6954 Fax: (304) 884-7198
Midland, TX Phone: (432) 561-9933 Fax: (432) 561-9934
Williams, CA Phone: (530) 473-5319 Fax: (530) 473-5393
Zephyrhills, FL Phone: (813) 783-7439 Fax: (813) 783-7214

Reviewed by:

Donald R. Poindexter, PE
Florida Lic. No. 64901
4119 Trinity Dr Santa Rosa CA 95405
Phone 707-494-8761

Seal:

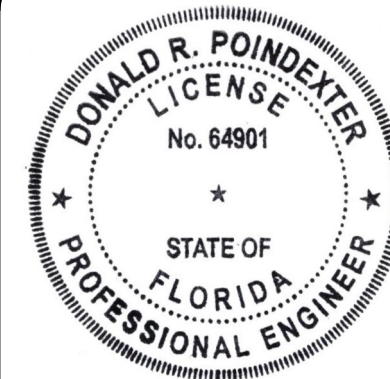

Length, width and depth may vary up to 3% - all dimensions are to outside edge of coping, measured from parallel lines.

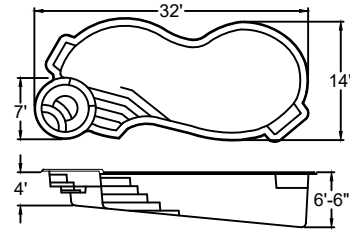

SUNSET BAY - BHSY
10,000 Gal. Approx.

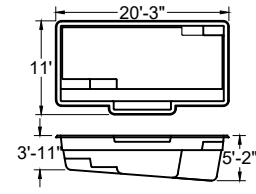

TUSCAN 11.20 - SYM06
5,000 gal. approx.

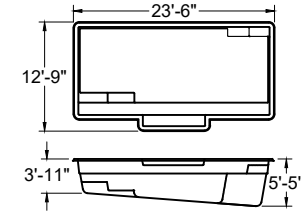

TUSCAN 13.24 - SYM07
6,100 gal. approx.

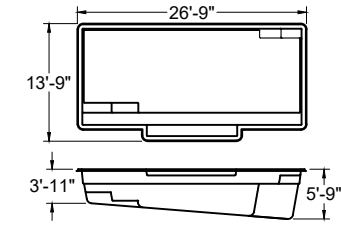

TUSCAN 14.27 - SYM08
7,900 gal. approx.

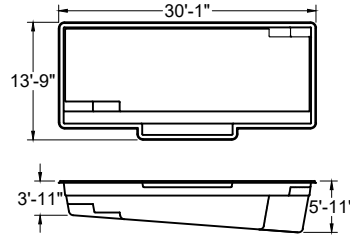

TUSCAN 14.30 - SYM09
10,000 gal. approx.

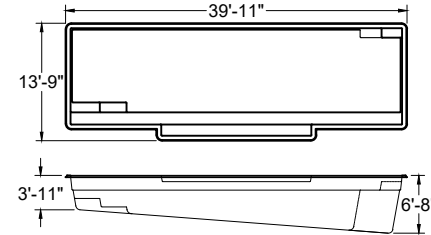

TUSCAN 14.40 - SYM12
12,200 gal. approx.

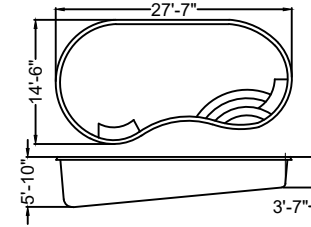

VALENCIA - ST
10,000 gal. approx.

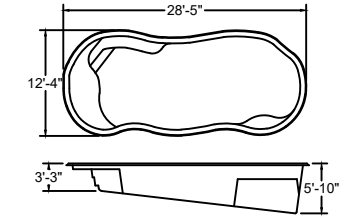

VISTA ISLE - BHVI
8,000 Gal. Approx.

NOTES

Latham Pool Products Inc.
DBA Latham Grand, Latham Select
Viking Pool, Blue Hawaiian Pools, Trilogy Pools
ICC Evaluation Report Number (ESR-2014)

Latham, NY Phone: (800) 833-3800
Jane Lew, WV Phone: (304) 884-6954 Fax: (304) 884-7198
Midland, TX Phone: (432) 561-9933 Fax: (432) 561-9934
Williams, CA Phone: (530) 473-5319 Fax: (530) 473-5393
Zephyrhills, FL Phone: (813) 783-7439 Fax: (813) 783-7214

Reviewed by:

Donald R. Poindexter, PE
Florida Lic. No. 64901
4119 Trinity Dr Santa Rosa CA 95405
Phone 707-494-8761

Seal:

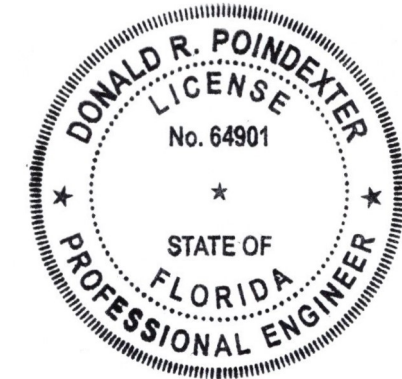

Page 6 of 8

Pool Models

C-006

Length, width and depth may vary up to 3% - all dimensions are to outside edge of coping, measured from parallel lines.

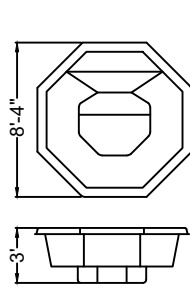

PLACID - BOS
475 Gal. Approx.

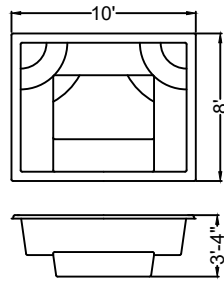

ROYAL - RY
600 Gal. Approx.

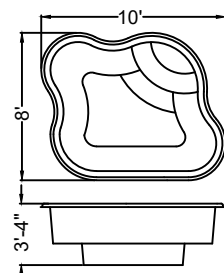

REGAL - RG
600 Gal. Approx.

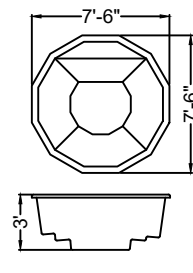

TAHOE - LOS
450 Gal. Approx.

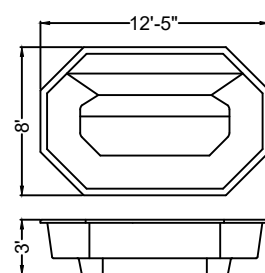

SUPERIOR - CS
700 Gal. Approx.

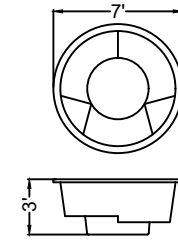

SHASTA - LRS
420 Gal. Approx.

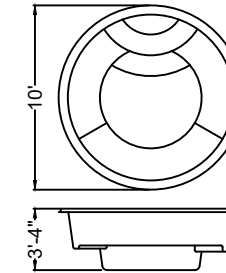

MYSTIC - M
550 Gal. Approx.

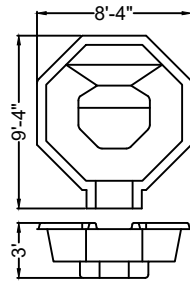

PLACID SPILLWAY- BOSSW
475 Gal. Approx.

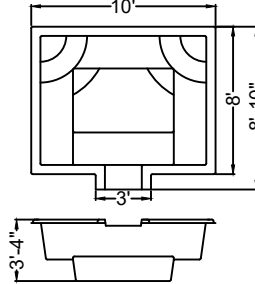

ROYAL SPILLWAY- RSW
600 Gal. Approx.

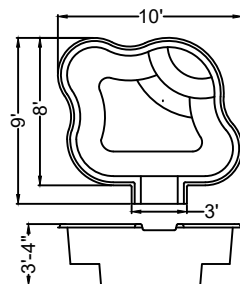

REGAL SPILLWAY- RGSW
600 Gal. Approx.

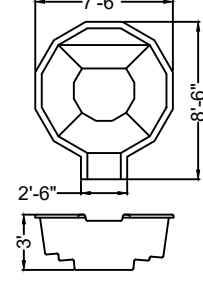

TAHOE SPILLWAY- LOSSW
450 Gal. Approx.

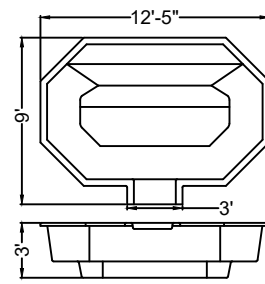

SUPERIOR SPILLWAY- CSSW
700 Gal. Approx.

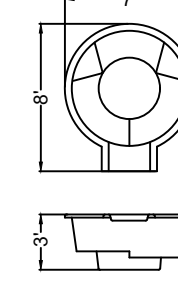

SHASTA SPILLWAY - LRSSW
420 Gal. Approx.

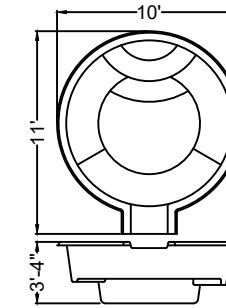

MYSTIC SPILLWAY- MSW
550 Gal. Approx.

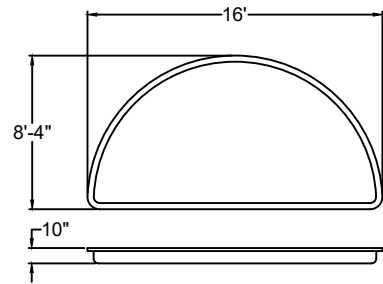

SEMI CIRCLE TANNING LEDGE - TSCT
400 Gal. Approx.

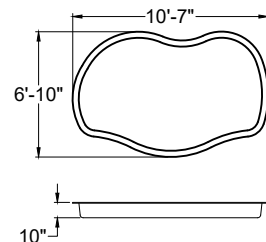

HERMOSA - VFTL
200 Gal. Approx.

NOTES

Latham Pool Products Inc.
DBA Latham Grand, Latham Select
Viking Pool, Blue Hawaiian Pools, Trilogy Pools
ICC Evaluation Report Number (ESR-2014)

Latham, NY Phone: (800) 833-3800
Jane Lew, WV Phone: (304) 884-6954 Fax: (304) 884-7198
Midland, TX Phone: (432) 561-9933 Fax: (432) 561-9934
Williams, CA Phone: (530) 473-5319 Fax: (530) 473-5393
Zephyrhills, FL Phone: (813) 783-7439 Fax: (813) 783-7214

Reviewed by:
Donald R. Poindexter, PE
Florida Lic. No. 64901
4119 Trinity Dr Santa Rosa CA 95405
Phone 707-494-8761

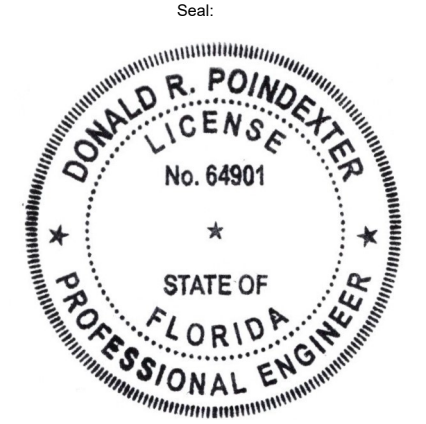

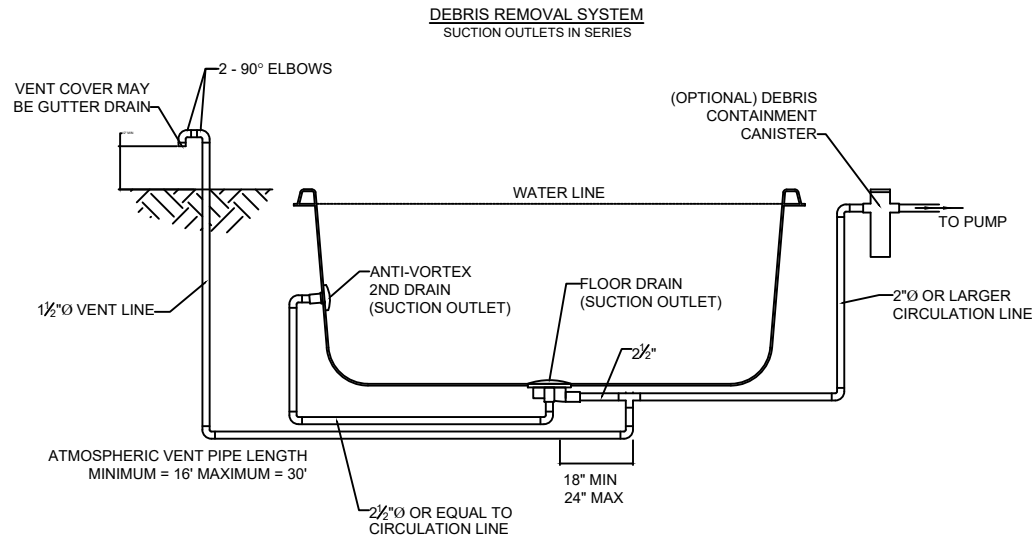

GENERAL NOTES

1. THE DEBRIS REMOVAL SYSTEM IS TO BE INSTALLED IN ACCORDANCE WITH DRAIN MANUFACTURER'S RECOMMENDATIONS.
2. CONTRACTOR TO INSTALL VACUUM RELIEF BACKUP SYSTEM IN ACCORDANCE WITH FBC-BUILDING AND RESIDENTIAL.
3. ALL PIPING TO BE SCHEDULE 40 PVC BEARING NSF APPROVAL UNLESS OTHERWISE NOTED.
4. THE FLOOR DRAIN AND DRAIN COVERS MEET THE REQUIREMENTS OF ANSI/APSP/ICC-16 2017 (PA2021) SUCTION OUTLET FITTING ASSEMBLIES AND ANSI/APSP/ICC-7 2020 STANDARD FOR SUCTION ENTRAPMENT AVOIDANCE.
5. THIS DRAWING WILL SUPPLEMENT CONTRACTOR'S SPECIFICATION DRAWING ON FILE. FOR METHODS AND MATERIALS OF CONSTRUCTION, REFER TO CONTRACTOR'S ENGINEERED AND SEALED SPECIFICATION DRAWING ON FILE WITH THE BUILDING DEPARTMENT.
6. ATTACH PLACARD WHICH STATES THAT VENT IS A SWIMMING POOL SAFETY DEVICE AND SHOULD NOT BE TAMPERED WITH.
7. THE MAXIMUM VACUUM WITH ONE SUMP PLUGGED AND TO RELEASE A BODY ENTRAPMENT ON THE OTHER SUMP WILL NOT EXCEED 4.5 INCHES OF MERCURY IN 3 SECONDS
8. MAXIMUM SUCTION PIPE VELOCITY SIX (6) FPS OR 59 GPM
9. AN APPROVED VACUUM RELEASE SYSTEM SUCH AS THE VAC-ALERT SVRS SYSTEM IS AN ALTERNATIVE TO THE OTHER SYSTEMS SHOWN.

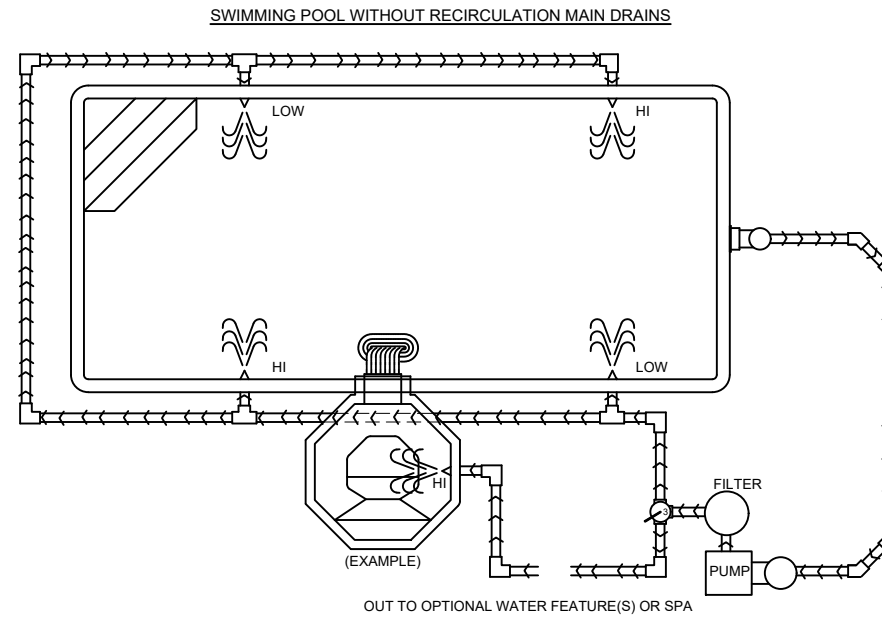

STANDARD NOTES:

1. USE 2" SCHEDULE 40 PIPE.
2. DO NOT USE 90 DEGREE ELBOWS ON SUCTION SIDE.
3. CHECK VALVES MAY BE NEEDED IF EQUIPMENT IS MORE THAN 18' ABOVE WATER LINE.
4. KEEP VALVES WITHIN 5' OF THE PUMP AND/OR FILTER.

LEGEND

	FIBER OPTIC LIGHT		T-JOINT
	SKIMMER		3" MAIN DRAIN
	RETURN		3-WAY VALVE
	SPILLOVER		PLUMBING

NOTES

Latham Pool Products Inc.
 DBA Latham Grand, Latham Select
 Viking Pool, Blue Hawaiian Pools, Trilogy Pools
 ICC Evaluation Report Number (ESR-2014)

Latham, NY Phone: (800) 833-3800
 Jane Lew, WV Phone: (304) 884-6954 Fax: (304) 884-7198
 Midland, TX Phone: (432) 561-9933 Fax: (432) 561-9934
 Williams, CA Phone: (530) 473-5319 Fax: (530) 473-5393
 Zephyrhills, FL Phone: (813) 783-7439 Fax: (813) 783-7214

Page 8 of 8
 Alternative
 Recirculation
 Systems
 C-008

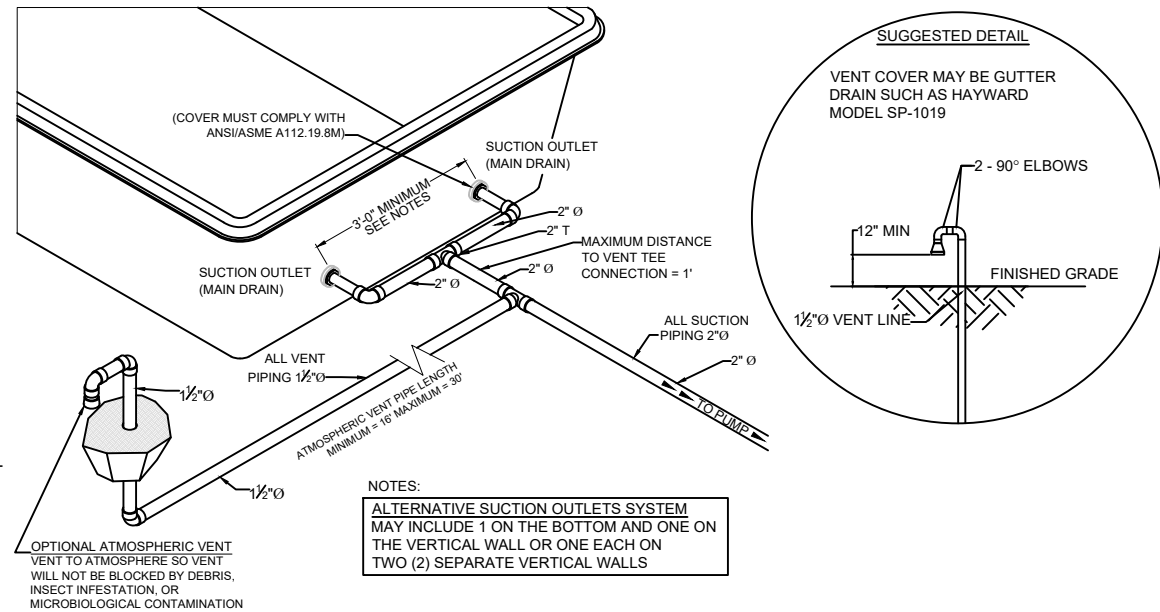

ADDITIONAL NOTES:

1. Entrapment protection for suction outlets must be installed in accordance with ANSI/APSP/ICC-7, R4501.6.6. 2.
2. Components must provide a complete turnover of pool water in 12 hours or less, R4501.20.
3. Main suction outlet velocity must comply with ANSI/APSP/ICC 7, R4501.6.3. Water velocity shall not exceed 10 FPS for pressure piping and 8 FPS for suction piping. Water velocity in copper piping shall not exceed 8 FPS. (See General Notes, No. 8).
4. Inlet fittings for the return of recirculated water shall be one per 300 SF of surface area. Minimum distance between two required inlets is 10 ft., R4501.21.5.
5. Surface skimmers shall be one per 800 SF of surface area or fraction thereof, and each have a flow rate of at least 25 gallons per minute, R4501.21.2.
6. Pool electrical wiring, installation, bonding, and grounding shall comply with 2023 FBC-Building and Residential, 8th Ed. and NFPA 70, 2020 Ed., R4501.16.

Reviewed by:

Donald R. Poindexter, PE
 Florida Lic. No. 64901
 4119 Trinity Dr Santa Rosa CA 95405
 Phone 707-494-8761

Seal:

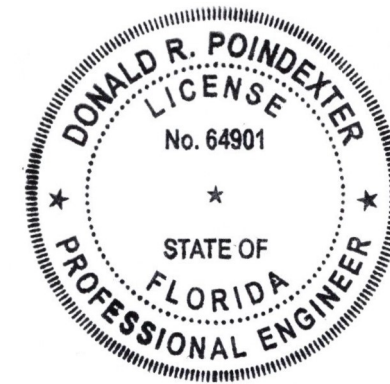

Length, width and depth may vary up to 3% - all dimensions are to outside edge of coping, measured from parallel lines.

DUAL SUCTION OUTLETS IN PARALLEL WITH OPTIONAL ATMOSPHERIC VENT SYSTEM TO BE INSTALLED IN ACCORD WITH 2023 FBC-BUILDING AND RESIDENTIAL, 8th Ed., ANSI/APSP/ICC-16 AND ANSI/APSP/ICC-7 2020. N.T.S.