

DATE 04/30/2010

Columbia County Building Permit

PERMIT

This Permit Must Be Prominently Posted on Premises During Construction

000028530

APPLICANT WENDY GRENNELL PHONE 288-2428
 ADDRESS 3104 SW OLD WIRE ROAD FT. WHITE FL 32038
 OWNER PAMELA STEELE/JANET BALLANCE PHONE 965-0891
 ADDRESS 810 SW FAITH ROAD LAKE CITY FL 32025
 CONTRACTOR GARY NEWSOME PHONE 386 792-2315
 LOCATION OF PROPERTY 90W, TL BRANFORD HIGHWAY, TL BASCOM NORRIS, TR FAITH RD,
TR CARDINAL, SITE ON RIGHT

TYPE DEVELOPMENT MODULAR ESTIMATED COST OF CONSTRUCTION 0.00
 HEATED FLOOR AREA 840.00 TOTAL AREA _____ HEIGHT _____ STORIES 1
 FOUNDATION _____ WALLS _____ ROOF PITCH _____ FLOOR _____
 LAND USE & ZONING CI MAX. HEIGHT _____
 Minimum Set Back Requirments: STREET-FRONT 20.00 REAR 15.00 SIDE 5.00
 NO. EX.D.U. 0 FLOOD ZONE X DEVELOPMENT PERMIT NO. _____

PARCEL ID 01-4S-16-02662-000 SUBDIVISION BUILDING B
 LOT _____ BLOCK _____ PHASE _____ UNIT _____ TOTAL ACRES 6.50

CBC1250895
 Culvert Permit No. _____ Culvert Waiver _____ Contractor's License Number _____ Applicant/Owner/Contractor Wendy Grennell
 EXISTING 10-131 BK HD
 Driveway Connection _____ Septic Tank Number _____ LU & Zoning checked by _____ Approved for Issuance _____ New Resident _____

COMMENTS: ONE FOOT ABOVE THE ROAD, NOC ON FILE

Check # or Cash CASH

FOR BUILDING & ZONING DEPARTMENT ONLY

(footer/Slab)

Temporary Power _____ Foundation _____ Monolithic _____
 date/app. by _____ date/app. by _____ date/app. by _____
 Under slab rough-in plumbing _____ Slab _____ Sheathing/Nailing _____
 date/app. by _____ date/app. by _____ date/app. by _____
 Framing _____ Insulation _____
 date/app. by _____ date/app. by _____
 Rough-in plumbing above slab and below wood floor _____ Electrical rough-in _____
 date/app. by _____ date/app. by _____
 Heat & Air Duct _____ Peri. beam (Lintel) _____ Pool _____
 date/app. by _____ date/app. by _____ date/app. by _____
 Permanent power _____ C.O. Final _____ Culvert _____
 date/app. by _____ date/app. by _____ date/app. by _____
 Pump pole _____ Utility Pole _____ M/H tie downs, blocking, electricity and plumbing _____
 date/app. by _____ date/app. by _____ date/app. by _____
 Reconnection _____ RV _____ Re-roof _____
 date/app. by _____ date/app. by _____ date/app. by _____

BUILDING PERMIT FEE \$ 0.00 CERTIFICATION FEE \$ 0.00 SURCHARGE FEE \$ 0.00
 MISC. FEES \$ 350.00 ZONING CERT. FEE \$ 50.00 FIRE FEE \$ 0.00 WASTE FEE \$ _____
 FLOOD DEVELOPMENT FEE \$ _____ FLOOD ZONE FEE \$ 25.00 CULVERT FEE \$ _____ **TOTAL FEE** 425.00
 INSPECTORS OFFICE [Signature] CLERKS OFFICE [Signature]

NOTICE: IN ADDITION TO THE REQUIREMENTS OF THIS PERMIT, THERE MAY BE ADDITIONAL RESTRICTIONS APPLICABLE TO THIS PROPERTY THAT MAY BE FOUND IN THE PUBLIC RECORDS OF THIS COUNTY. AND THERE MAY BE ADDITIONAL PERMITS REQUIRED FROM OTHER GOVERNMENTAL ENTITIES SUCH AS WATER MANAGEMENT DISTRICTS, STATE AGENCIES, OR FEDERAL AGENCIES.

"WARNING TO OWNER: YOUR FAILURE TO RECORD A NOTICE OF COMMENCEMENT MAY RESULT IN YOUR PAYING TWICE FOR IMPROVEMENTS TO YOUR PROPERTY. IF YOU INTEND TO OBTAIN FINANCING, CONSULT WITH YOUR LENDER OR AN ATTORNEY BEFORE RECORDING YOUR NOTICE OF COMMENCEMENT."

EVERY PERMIT ISSUED SHALL BECOME INVALID UNLESS THE WORK AUTHORIZED BY SUCH PERMIT IS COMMENCED WITHIN 180 DAYS AFTER ITS ISSUANCE, OR IF THE WORK AUTHORIZED BY SUCH PERMIT IS SUSPENDED OR ABANDONED FOR A PERIOD OF 180 DAYS AFTER THE TIME THE WORK IS COMMENCED. A VALID PERMIT RECIEVES AN APPROVED INSPECTION EVERY 180 DAYS. WORK SHALL BE CONSIDERED NOT SUSPENDED, ABANDONED OR INVALID WHEN THE PERMIT HAS RECIEVED AN APPROVED INSPECTION WITHIN 180 DAYS OT THE PREVIOUS INSPECTION.

The Issuance of this Permit Does Not Waive Compliance by Permittee with Deed Restrictions.

AREA OF DEVELOPMENT

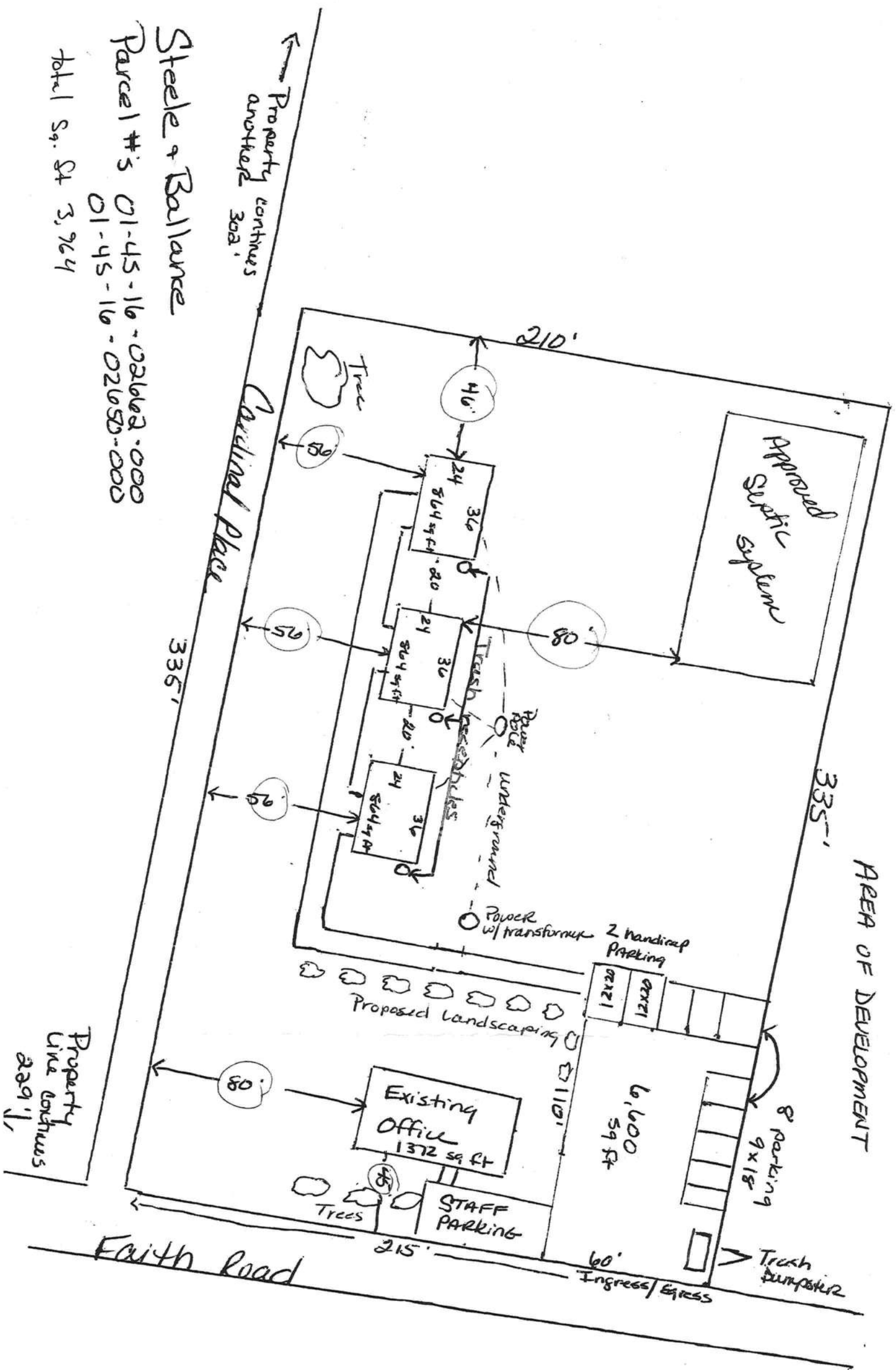

Steele & Ballance

Parcel #'s 01-45-16-02662-000
01-45-16-02652-000

total Sq. Ft 3,964

Property continues another 302'

Cardinal Place

335'

Faith Road

Property line continues 229'

Existing Office
1372 sq ft

STAFF PARKING

6,600
59 ft

8 parking
9x18

Trash Dumpster

Ingress/Egress

Proposed Site

2 handicap parking

Power w/ transformer

Underground

Trash Recycle

Proposed Landscaping

Trees

Tree

210'

335'

95'

95'

80'

80'

46'

56'

56'

56'

56'

56'

56'

56'

56'

56'

56'

56'

56'

56'

56'

56'

56'

56'

56'



COLUMBIA COUNTY FIRE RESCUE

P.O. BOX 1529 Lake City, Florida 32056
Office (386) 754-7071 Fax (386) 754-7064

Division Chief
David L. Boozer

07 May 10

TO: Harry Dicks
Columbia County Building and Zoning

FROM: David L. Boozer
Division Chief / Fire Marshal

RE: Permit # 28527, 28530, 28532

A plan review was performed of the proposed school to be located off SW Faith Road. This property falls under Chapter 14 of the Florida Fire Prevention Code, 2007 edition. I recommend approval.

Should you require any additional information, please feel free to contact my office.

Sincerely,

David L. Boozer

Columbia County Building Permit Application

For Office Use Only Application # 1003-50 Date Received 3/30/10 By G Permit # 28530
 Zoning Official BLK Date 30.04.10 Flood Zone X FEMA Map # N/A Zoning CI
 Land Use Com. Elevation N/A MFE 1st floor River N/A Plans Examiner HD Date 4-26-10
 Comments _____
 NOC EH Deed or PA Site Plan State Road Info Parent Parcel # _____
 Dev Permit # _____ In Floodway Letter of Authorization from Contractor VF complete
 Unincorporated area Incorporated area Town of Fort White Town of Fort White Compliance letter

Septic Permit No. _____ Fax 386-755-1031

Name Authorized Person Signing Permit Wendy Grennell Phone 386-288-2428

Address 3104 SW Old Wire Road Ft White FL 32038

Owners Name Pamela Steele + Janet Ballance Phone 386-965-0891

911 Address 810 SW Faith Rd - Lake City FL 32025

Contractors Name Gary Newsome Phone 386-792-2315

Address 3792 NW Hwy 41 Jennings FL 32053

Fee Simple Owner Name & Address N/A

Bonding Co. Name & Address N/A

Architect/Engineer Name & Address William S. McCann 1563 Turner St.

Mortgage Lenders Name & Address N/A Clearwater FL 33782

Circle the correct power company - FL Power & Light - Clay Elec. - Suwannee Valley Elec. - Progress Energy

Bldg B.

Property ID Number 01-45-16-021662-000 + 020802-000 Estimated Cost of Construction 6500

Subdivision Name N/A Lot N/A Block N/A Unit N/A Phase N/A

Driving Directions 90 West to Branford Hwy turn (L) to Bascom Norris S turn (L) to Faith Rd turn (R) to Cardinal turn (R) set
on (R) Number of Existing Dwellings on Property 1

Construction of modular building Total Acreage 6.5 Lot Size 215x333

Do you need a - Culvert Permit or Culvert Waiver or Have an Existing Drive Total Building Height _____

Actual Distance of Structure from Property Lines - Front 56 Side 92' Side 167" Rear 90'

Number of Stories 1 Heated Floor Area 840 Total Floor Area 840 Roof Pitch _____

Application is hereby made to obtain a permit to do work and installations as indicated. I certify that no work or installation has commenced prior to the issuance of a permit and that all work be performed to meet the standards of all laws regulating construction in this jurisdiction.

Columbia County Building Permit Application

TIME LIMITATIONS OF APPLICATION : An application for a permit for any proposed work shall be deemed to have been abandoned 180 days after the date of filing, unless such application has been pursued in good faith or a permit has been issued; except that the building official is authorized to grant one or more extensions of time for additional periods not exceeding 90 days each. The extension shall be requested in writing and justifiable cause demonstrated.

TIME LIMITATIONS OF PERMITS: Every permit issued shall become invalid unless the work authorized by such permit is commenced within 180 days after its issuance, or if the work authorized by such permit is suspended or abandoned for a period of 180 days after the time work is commenced. A valid permit receives an approved inspection every 180 days. Work shall be considered not suspended, abandoned or invalid when the permit has received an approved inspection within 180 days of the previous approved inspection.

FLORIDA'S CONSTRUCTION LIEN LAW: Protect Yourself and Your Investment: According to Florida Law, those who work on your property or provide materials, and are not paid-in-full, have a right to enforce their claim for payment against your property. This claim is known as a construction lien. If your contractor fails to pay subcontractors or material suppliers or neglects to make other legally required payments, the people who are owed money may look to your property for payment, even if you have paid your contractor in full. This means if a lien is filed against your property, it could be sold against your will to pay for labor, materials or other services which your contractor may have failed to pay.

NOTICE OF RESPONSIBILITY TO BUILDING PERMITEE: **YOU ARE HEREBY NOTIFIED** as the recipient of a building permit from Columbia County, Florida, you will be held responsible to the County for any damage to sidewalks and/or road curbs and gutters, concrete features and structures, together with damage to drainage facilities, removal of sod, major changes to lot grades that result in ponding of water, or other damage to roadway and other public infrastructure facilities caused by you or your contractor, subcontractors, agents or representatives in the construction and/or improvement of the building and lot for which this permit is issued. No certificate of occupancy will be issued until all corrective work to these public infrastructures and facilities has been corrected.

WARNING TO OWNER: YOUR FAILURE TO RECORD A NOTICE OF COMMENCEMENT MAY RESULT IN YOU PAYING TWICE FOR IMPROVEMENTS TO YOUR PROPERTY. A NOTICE OF COMMENCEMENT MUST BE RECORDED AND POSTED ON THE JOB SITE BEFORE THE FIRST INSPECTION. IF YOU INTEND TO OBTAIN FINANCING, CONSULT WITH YOUR LENDER OR ATTORNEY BEFORE RECORDING YOUR NOTICE OF COMMENCEMENT.

OWNERS CERTIFICATION: I CERTIFY THAT ALL THE FOREGOING INFORMATION IS ACCURATE AND THAT ALL WORK WILL BE DONE IN COMPLIANCE WITH ALL APPLICABLE LAWS REGULATING CONSTRUCTION AND ZONING.

NOTICE TO OWNER: There are some properties that may have deed restrictions recorded upon them. These restrictions may limit or prohibit the work applied for in your building permit. It may be to your advantage to check and see if your property is encumbered by any restrictions.

(Owners Must Sign All Applications Before Permit Issuance.)

Pamela Steele Janet Ballance
Owners Signature

****OWNER BUILDERS MUST PERSONALLY APPEAR AND SIGN THE BUILDING PERMIT.**

CONTRACTORS AFFIDAVIT: By my signature I understand and agree that I have informed and provided this written statement to the owner of all the above written responsibilities in Columbia County for obtaining this Building Permit including all application and permit time limitations.

Bary New
Contractor's Signature (Permitee)

Contractor's License Number CBC1250895
Columbia County
Competency Card Number _____

Affirmed under penalty of perjury to by the Contractor and subscribed before me this 30 day of March 2010.

Personally known _____ or Produced Identification Drivers License

Shirley M Bennett
State of Florida Notary Signature (For the Contractor)

SEAL:

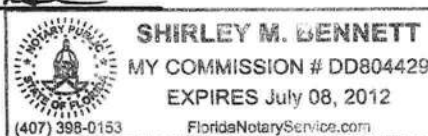

Toll Free: 1-800-338-5088
Local: (386) 935-2832
Fax: (386) 935-1020

SECURITY SAFE COMPANY

For all your security needs

STATE CERTIFIED LICENSES
EFA000353
EG13000258

Sales & Service
7585 - 216th Street
O'Brien, FL 32071

Internet Address
www.securitysafe.com

April 27, 2010

A Plus Learning Academy
810 SW Faith Road
Lake City, FL 32025
(386) 438-5495

Re: Fire Alarm Protection

*** COMMERCIAL UL FIRE ALARM SYSTEM ***

- 1-Central Controller (With Back-up Battery Power)
UL Approved Commercial Fire Panel, 2-Line Dialer
- 2-Phone Line Seizure Interface RJ31X Jacks
- 2-Phone Wire Installed in Fire Wire, 2-Lines Required
- 1-Remote Annunciator Keypad
- 10-Pull Station Stations
- 7-Interior Horn/Strobe/Lights
- 4-Strobe Light Only Rest Rooms
- 11-Smoke/Heat Detectors
- 1-Smoke/Heat Detector Over Fire Panel for Protection
- 1-Lightning Protection Detached Buildings
- 1-Wiring & Conduit
- * Electrical Connection to be provided...
- * All Wiring is NFPA Fire Alarm Wire.
- * Installation Meets All NEC & NFPA Fire Codes.
- * Two Phone Lines to be provided...per Code
- * Must Meet NFPA Inspections as Needed, Annual.
- * All Trenching to be provided by owner...

Total: \$8894.00 plus tax
Labor: DONATED (\$1675.00)

ALARM MONITORING:

Central Station Set-Up Fee \$ 45.00 One Time Fee
Quarterly Alarm Monitoring \$120.00 @ 40.00 month

Payment to be made as follows: 50% Due Upon Acceptance,
Balance Due Upon Trim-Out Completion.

Thank you for allowing Security Safe Company to assist you
in all your security needs...

Acceptance

Sincerely,

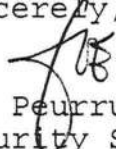
Joe Peurrung
Security Safe Co., Inc.
State Certified EFA000353



Security, Fire & Medical Alarms • Safes & Gun Vaults
Security Gating • Central Vacuums • Structural Wiring
Home Theater • Phone & Intercom Systems • Access Controls
Camera Surveillance • Automatic Standby Generators





COLUMBIA COUNTY 911 ADDRESSING / GIS DEPARTMENT

P. O. Box 1787, Lake City, FL 32056-1787
Telephone: (386) 758-1125 * Fax: (386) 758-1365 * Email: ron_croft@columbiacountyfla.com



ADDRESS ASSIGNMENT DATA

The Columbia County Board of County Commissioners has passed Ordinance 2001-9, which provides for a uniform numbering system. A copy of this ordinance is available in the Clerk of Court records, located in the courthouse. This new numbering system will increase the efficiency of POLICE, FIRE AND EMERGENCY MEDICAL vehicles responding to calls within Columbia County by immediately identifying the location of the caller.

A Residential or Other Structure(s) on Parcel Number:
01-4S-16-02662-000

Address Assignment(s):
810 SW FAITH RD, LAKE CITY, FL, 32025

*office Bldg.
w mod.*

Any questions concerning this information should be referred to the Columbia County 911 Addressing / GIS Department at the address or telephone number above.

SUBCONTRACTOR VERIFICATION FORM

APPLICATION NUMBER _____ CONTRACTOR _____ PHONE _____

THIS FORM MUST BE SUBMITTED PRIOR TO THE ISSUANCE OF A PERMIT

In Columbia County one permit will cover all trades doing work at the permitted site. It is **REQUIRED** that we have records of the subcontractors who actually did the trade specific work under the permit. Per Florida Statute 440 and Ordinance 89-6, a contractor shall require all subcontractors to provide evidence of workers' compensation or exemption, general liability insurance and a valid Certificate of Competency license in Columbia County.

Any changes, the permitted contractor is responsible for the corrected form being submitted to this office prior to the start of that subcontractor beginning any work. Violations will result in stop work orders and/or fines.

ELECTRICAL <i>#535 Good</i>	Print Name <u>THOMAS STEVEN THOMAS</u> Signature <u><i>(Signature)</i></u>	License #: <u>EC 0001121</u> Phone #: <u>(386) 752-5125</u>
MECHANICAL/A/C	Print Name _____ Signature _____	License #: _____ Phone #: _____
PLUMBING/GAS	Print Name _____ Signature _____	License #: _____ Phone #: _____
ROOFING	Print Name _____ Signature _____	License #: _____ Phone #: _____
SHEET METAL	Print Name _____ Signature _____	License #: _____ Phone #: _____
FIRE SYSTEM/SPRINKLER	Print Name _____ Signature _____	License #: _____ Phone #: _____
SOLAR	Print Name _____ Signature _____	License #: _____ Phone #: _____

Specialty License	License Number	Sub-Contractors Printed Name	Sub-Contractors Signature
MASON			
CONCRETE FINISHER			
FRAMING			
INSULATION			
STUCCO			
DRYWALL			
PLASTER			
CABINET INSTALLER			
PAINTING			
ACOUSTICAL CEILING			
GLASS			
CERAMIC TILE			
FLOOR COVERING			
ALUM/VINYL SIDING			
GARAGE DOOR			
METAL BLDG ERECTOR			

F. S. 440.103 Building permits; identification of minimum premium policy.--Every employer shall, as a condition to applying for and receiving a building permit, show proof and certify to the permit issuer that it has secured compensation for its employees under this chapter as provided in ss. 440.10 and 440.38, and shall be presented each time the employer applies for a building permit.

Return to: (enclose self-addressed stamped envelope)

Name:

Address:

This Instrument Prepared by:

Name: Janet Ballance

Address: 400 SW Dekle Rd
Lake City, FL 32024

Property Appraiser's Parcel Identification

Public Number(s):

Grantor(s) S.S. # (s)

Inst: 2006014974 Date: 06/21/2006 Time: 16:17

Doc Stamp-Deed: 175.00

DC, P. DeWitt Cason, Columbia County B: 1087 P: 1588

SPACE ABOVE THIS LINE FOR PROCESSING DATA

SPACE ABOVE THIS LINE FOR RECORDING DATA

This Quit Claim Deed, Executed the 21st day of June, 2006, by
Mozell Bennett

first party, to William K. Ballance and Janet Ballance
whose post office address is 400 Sw Dekle Rd. Lake City, FL
second party.

(Wherever used herein the terms "first party" and "second party" include all the parties to this instrument and the heirs, legal representatives, and assigns of individuals, and the successors and assigns of corporations, wherever the context so admits or requires.)

Witnesseth, That the first party, for and in consideration of the sum of \$ 25,000
in hand paid by the said second party, the receipt whereof is hereby acknowledged, does hereby remise, release,
and quit claim unto the second party forever, all the right, title, interest, claim and demand which the said first
party has in and to the following described lot, piece or parcel of land, situate, lying and being in the County of
Columbia, State of Florida, to-wit:

Commence at the NW Corner of the SE 1/4 of NW 1/4, Section 1, Township 4 South,
Range 16 East and run South 2 degrees 4 minutes East, 326.60 ft. to the
Southerly right-of-way line of State Road 247, thence South 48 degrees 30 minutes
East 547.18 ft. TO THE POINT OF BEGINNING, and run thence North 48 degrees
17 minutes 22 seconds East 211.52 ft., thence South 48 degrees 30 minutes
East 51.66 ft., thence South 41 degrees 30 seconds West 210.0 ft., thence
North 48 degrees 30 minutes West 81.66 ft. TO THE POINT OF BEGINNING.

To Have and to Hold The same together with all and singular the appurtenances thereunto belonging
or in anywise appertaining, and all the estate, right, title, interest, lien, equity and claim whatsoever of the said
first party, either in law or equity to the only proper use, benefit and behoof of the said second party forever.

In Witness Whereof, the said first party has signed and sealed these presents the day and year first
above written.

Signed, sealed and delivered in the presence of:

Dana P. Huggins
Witness Signature (as to first Grantor)

Dana P. Huggins
Printed Name

Joyce L. Spradley
Witness Signature (as to first Grantor)

Joyce L. Spradley
Printed Name

Maryann Moates
Witness Signature (as to Co-Grantor, if any)

Maryann Moates
Printed Name

Harriet Woods
Witness Signature (as to Co-Grantor, if any)

Harriet Woods
Printed Name

STATE OF FL
COUNTY OF Columbia

Mozell Bennett
Grantor Signature

Mozell Bennett
Printed Name

222 S.W. Cardinal Pl. Lake City FL
Post Office Address 32025

Co-Grantor Signature, (if any)

Printed Name

Post Office Address

I hereby Certify that on this day, before me, an officer duly authorized
to administer oaths and take acknowledgments, personally appeared

known to me to be the person described in and who executed the foregoing instrument, who acknowledged before me that
executed the same, and an oath was not taken. (Check one:) Said person(s) is/are personally known to me. Said person(s) provided the
following type of identification:

NOTARY RUBBER STAMP SEAL

 Belinda Austin
My Commission DD173511
Expires February 21, 2007

Witness my hand and official seal in the County and State last aforesaid
this 21st day of June, 2006
Date

Belinda Austin
Notary Signature
Belinda Austin
Printed Name

Columbia County Property Appraiser

DB Last Updated: 1/28/2010

2009 Tax Roll Year

Parcel: 01-4S-16-02650-000

<< Next Lower Parcel Next Higher Parcel >>

<< Prev Search Result: 5 of 7 Next >>

Owner & Property Info

Owner's Name	BALLANCE WILLIAM K & JANET		
Mailing Address	400 SW DEKLE RD LAKE CTIY, FL 32024		
Site Address	222 SW CARDINAL PL		
Use Desc. (code)	SINGLE FAM (000100)		
Tax District	2 (County)	Neighborhood	1416
Land Area	0.480 ACRES	Market Area	06
Description	NOTE: This description is not to be used as the Legal Description for this parcel in any legal transaction.		
COMM NW COR SE1/4 OF NW1/4, CUN S 326.60 FT TO S R/W OF SR-247, RUN SE 547.18 FT FOR POB, RUN NE 211.52 FT, SE 51.66 FT, SW 210 FT, NW ALONG R/W 81.66 FT TO POB. ORB 397-183, 748-392, PROB# 91-185-CP, WD WITH INCOMPLETE LEGAL DESC * 1 WITNESS ORB 957-399, QC 1087-1588,			



Property & Assessment Values

2009 Certified Values	
Mkt Land Value	cnt: (0) \$14,971.00
Ag Land Value	cnt: (1) \$0.00
Building Value	cnt: (1) \$35,921.00
XFOB Value	cnt: (1) \$100.00
Total Appraised Value	\$50,992.00
Just Value	\$50,992.00
Class Value	\$0.00
Assessed Value	\$50,992.00
Exempt Value	\$0.00
Total Taxable Value	Cnty: \$50,992 Other: \$50,992 Schl: \$50,992

2010 Working Values

NOTE:
2010 Working Values are NOT certified values and therefore are subject to change before being finalized for ad valorem assessment purposes.

Sales History

Sale Date	OR Book/Page	OR Code	Vacant / Improved	Qualified Sale	Sale RCode	Sale Price
6/21/2006	1087/1588	QC	I	U	01	\$25,000.00
9/30/2003	996/36	QC	I	U	01	\$100.00
7/1/2002	957/399	WD	I	U	01	\$100.00

Building Characteristics

Bldg Item	Bldg Desc	Year Blt	Ext. Walls	Heated S.F.	Actual S.F.	Bldg Value
1	SINGLE FAM (000100)	1955	SINGLE SID (04)	1180	1524	\$34,846.00
Note: All S.F. calculations are based on exterior building dimensions.						

Extra Features & Out Buildings

Code	Desc	Year Blt	Value	Units	Dims	Condition (% Good)
0294	SHED WOOD/	0	\$100.00	0000001.000	0 x 0 x 0	(000.00)

Land Breakdown

--	--	--	--	--	--	--



01-4S-16-02650-000
 BALLANCE WILLIAM K & JANET
 0.48AC | 6/21/2006 - \$25,000 - I/U

Columbia County Property Appraiser

J. Doyle Crews - Lake City, Florida | 386-758-1083

PARCEL: 01-4S-16-02650-000 - SINGLE FAM (000100)

COMM NW COR SE1/4 OF NW1/4, CUN S 326.60 FT TO S R/W OF SR-247, RUN SE 547.18 FT FOR POB, RUN NE 211.52 FT, SE 51.66 FT, SW 210 FT, NW ALONG RW 81.66

Name: BALLANCE WILLIAM K & JANET
 Site: 222 SW CARDINAL PL
 400 SW DEKLE RD
 Mail: LAKE CTY, FL 32024

Sales 6/21/2006 \$25,000.00 I/U
 Info 9/30/2003 \$100.00 I/U

2009 Certified Values

Land	\$14,971.00
Bldg	\$35,921.00
Assd	\$50,992.00
Exmpt	\$0.00
Taxbl	Cnty: \$50,992
	Other: \$50,992 Schl: \$50,992

NOTES:



This information, GIS Map Updated: 1/28/2010, was derived from data which was compiled by the Columbia County Property Appraiser Office solely for the governmental purpose of property assessment. This information should not be relied upon by anyone as a determination of the ownership of property or market value. No warranties, expressed or implied, are provided for the accuracy of the data herein, it's use, or it's interpretation. Although it is periodically updated, this information may not reflect the data currently on file in the Property Appraiser's office. The assessed values are NOT certified values and therefore are subject to change before being finalized for ad valorem assessment purposes.

powered by:
GrizzlyLogic.com

Ac. 10.50
Ex. 70

JEN:dac
2/10/99

99-03673

FILED AND RECORDED IN PUBLIC
RECORDS OF COLUMBIA COUNTY, FL

BK 0875 PG 2174

1999 MAR -5 AM 10:31

RECORD VERIFIED
BY: MKR



OFFICIAL RECORDS

Documentary Stamp .70
Intangible Tax
P. DeWitt Cason
Clerk of Court
By: MKR DC

SPECIAL WARRANTY DEED

THIS SPECIAL WARRANTY DEED, Made the 12th day of February, 1999, by CARRIE ZELL BLANTON, unmarried, P. O. Box 2267, Lake City, Florida 32056, hereinafter called the Grantor, to PAMELA BLANTON STEELE, whose Social Security Number is [REDACTED], 5584 150th Place, Wellborn, Florida 32094, hereinafter called the Grantee;

WITNESSETH:

That the Grantor, for and in consideration of the sum of TEN and No/100 (\$10.00) DOLLARS and other valuable considerations, receipt whereof is hereby acknowledged, by these presents does grant, bargain, sell, alien, remise, release, convey and confirm unto the Grantee, her heirs and assigns, the lands situate in Columbia County, Florida, described as follows:

TOWNSHIP 4 SOUTH, RANGE 16 EAST

Section 1:

Commence at the Northwest Corner of the SE 1/4 of the NW 1/4; run thence S 2°04' E, 326.60 feet for the POINT OF BEGINNING; run thence S 48°30' E, 630 feet; run thence N 41°30' E, 210 feet; run thence S 48°30' E, 284.09 feet to the centerline of Old Troy Road; run thence S 49°01' W along the centerline of Old Troy Road, 471.80 feet, more or less, to the Southwest corner of the lands described in O.R. Book 78, Page 247, public records of Columbia County, Florida; run thence N 48°30' W, 637.27 feet; run thence N 2°04' W, 317.6 feet to the POINT OF BEGINNING. All of said lands lying and being in the SE 1/4 of NW 1/4, containing 6.5 acres, more or less.

Parcel No. 01-4S-[REDACTED]

TOGETHER with all the tenements, hereditaments and appurtenances thereto belonging or in anywise appertaining.

TO HAVE AND TO HOLD, the same in fee simple forever.

AND the Grantor hereby covenants with said Grantee that the Grantor is lawfully seized of said land in fee simple; that the Grantor has good right and lawful authority to sell and convey said land; that the Grantor hereby warrants the title to said land and will defend the same against the lawful claims of all persons claiming by, through or under the said Grantor.

IN WITNESS WHEREOF, the Grantor has hereunto set her hand and

This Instrument Prepared By:
JOHN E. NORRIS
NORRIS, KOBERLEIN & ANDERSON, P.A.
P. O. Box 2349
Lake City, Florida 32056-2349

From a legal description
provided by Grantor and
without a title search.

seal the day and year first above written.

00875 162175

Signed, sealed and delivered
in the presence of:

OFFICIAL RECORDS

Sign [Signature]
Print Jane E. [Name]

Carrie Zell Blanton (SEAL)
CARRIE ZELL BLANTON

Sign [Signature]
Print Diane A. Crews

STATE OF FLORIDA
COUNTY OF COLUMBIA

The foregoing instrument was acknowledged before me this 12th
day of February, 1999, by CARRIE ZELL BLANTON, unmarried, who is
personally known to me or has presented [Signature] as
identification.

NOTARY PUBLIC:
Sign [Signature]
Print Diane A. Crews
State of Florida at Large (Seal)
My Commission Expires:

OFFICIAL NOTARY SEAL
DIANE A CREWS
NOTARY PUBLIC STATE OF FLORIDA
COMMISSION NO. 0079965
MY COMMISSION EXP. FEB. 9 2002



Columbia County Property Appraiser

J. Doyle Crews - Lake City, Florida | 386-758-1083

PARCEL: 01-4S-16-02662-000 - SINGLE FAM (000100)
 COMM NW COR OF SE1/4 OF NW1/4, RUN S 326.60 FT FOR POB, RUN S 48 DEG E 630 FT, N 41 DEG E 210 FT, S 48 DEG E 284.09 FT TO C/L OLD TROY RD, S 48 DEG W

Name: STEELE PAMELA BLANTON
 Site: 222 SW CARDINAL PL
 Mail: 5584 150TH PL
 WELLBORN, FL 32094
 Sales 2/12/1999 \$0.00 I / U
 Info 3/14/1995 \$0.00 I / U

2009 Certified Values

Land	\$152,460.00
Bldg	\$44,530.00
Assd	\$199,790.00
Exmpt	\$0.00
Taxbl	Cnty: \$199,790 Scht: \$199,790

NOTES:



This information, GIS Map Updated: 1/28/2010, was derived from data which was compiled by the Columbia County Property Appraiser Office solely for the governmental purpose of property assessment. This information should not be relied upon by anyone as a determination of the ownership of property or market value. No warranties, expressed or implied, are provided for the accuracy of the data herein, it's use, or it's interpretation. Although it is periodically updated, this information may not reflect the data currently on file in the Property Appraiser's office. The assessed values are NOT certified values and therefore are subject to change before being finalized for ad valorem assessment purposes.

powered by:
GrizzlyLogic.com

Inst: 201012004125 Date: 3/17/2010 Time: 10:44 AM
Doc. Stamp: Dead 0.70
DC, P DeWitt Cason, Columbia County Page 1 of 1 B: 1190 P: 2300

OSTDS Permit # _____
CCHD Tracking # _____
Applicant Name: Pamela Steele

Reference: Utility Easement for Maintenance of Onsite Sewage Treatment and Disposal System

This document serves as a written utility easement in accordance with Chapter 64E-6.004(7) of the Florida Administrative Code, which states:

- A. Where a property owner proposes to build or has built a single residence or a single business or multiple residences or businesses on multiple lots, and the residence's or business's authorized sewage flow requires the use of multiple lots, or parts thereof, for the onsite sewage treatment and disposal system, the property owner must submit, prior to issuance of a permit, a written utility easement executed and recorded in the public property records at the county courthouse. The utility easement must bind the required property together so that the original lots and their collective size, or parts thereof, is retained for purposes of the onsite sewage treatment and disposal system, and must include provisions for maintaining the onsite sewage treatment and disposal system.

For the purposes of constructing an onsite sewage treatment and disposal system, Parcel 02662-000, Lot(s) na, Block na, na S/D and Parcel 02650-000, Lot(s) na, Block na, na S/D, in Columbia County, Florida are bound together for sewage disposal by this utility mechanism until such time as an approved sewage alternative is available. Maintenance and all other costs of the system will be the responsibility of Parcel 02662-000.

X Property Owner: Pamela Steele
Parcel 02662-000 Steele

X Property Owner: Janet Ballance
Parcel 02650-000 Ballance

Signed, sealed and delivered in presence of:

Witness: Sheila Newcomb

Witness: Adam Houston

State of Florida
County of Columbia

I *Hereby Certify* that on this day, before me, an officer duly authorized in the State aforesaid and in the County aforesaid to take acknowledgments, personally appeared Pamela Steele / Janet Ballance who is personally known to me or produced the following identification personally known

Witness my hand and official seal in the County and State aforesaid this 16th Day of March, A.D., 2009.

Notary Public [Signature]

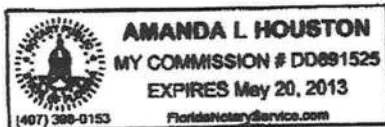

SUBCONTRACTOR VERIFICATION FORM

APPLICATION NUMBER 1003-50 CONTRACTOR Gary Newsome PHONE 792-2315

THIS FORM MUST BE SUBMITTED PRIOR TO THE ISSUANCE OF A PERMIT

In Columbia County one permit will cover all trades doing work at the permitted site. It is **REQUIRED** that we have records of the subcontractors who actually did the trade specific work under the permit. Per Florida Statute 440 and Ordinance 89-6, a contractor shall require all subcontractors to provide evidence of workers' compensation or exemption, general liability insurance and a valid Certificate of Competency license in Columbia County.

Any changes, the permitted contractor is responsible for the corrected form being submitted to this office prior to the start of that subcontractor beginning any work. Violations will result in stop work orders and/or fines.

ELECTRICAL	Print Name _____ License #: _____	Signature _____ Phone #: _____
MECHANICAL/ A/C	Print Name _____ License #: _____	Signature _____ Phone #: _____
PLUMBING/ GAS	Print Name <u>Gary Newsome</u> License #: <u>CBC1250895</u>	Signature <u>[Signature]</u> Phone #: <u>386-792-2315</u>
ROOFING	Print Name _____ License #: _____	Signature _____ Phone #: _____
SHEET METAL	Print Name _____ License #: _____	Signature _____ Phone #: _____
FIRE SYSTEM/ SPRINKLER	Print Name _____ License #: _____	Signature _____ Phone #: _____
SOLAR	Print Name _____ License #: _____	Signature _____ Phone #: _____

Specialty License	License Number	Sub-Contractors Printed Name	Sub-Contractors Signature
MASON			
CONCRETE FINISHER			
FRAMING			
INSULATION			
STUCCO			
DRYWALL			
PLASTER			
CABINET INSTALLER			
PAINTING			
ACOUSTICAL CEILING			
GLASS			
CERAMIC TILE			
FLOOR COVERING			
ALUM/VINYL SIDING			
GARAGE DOOR			
METAL BLDG ERECTOR			

F. S. 440.103 Building permits; identification of minimum premium policy.—Every employer shall, as a condition to applying for and receiving a building permit, show proof and certify to the permit issuer that it has secured compensation for its employees under this chapter as provided in ss. 440.10 and 440.38, and shall be presented each time the employer applies for a building permit.

SUBCONTRACTOR VERIFICATION FORM

APPLICATION NUMBER 1003-50 CONTRACTOR Gary Newsome PHONE 386-792-2315

THIS FORM MUST BE SUBMITTED PRIOR TO THE ISSUANCE OF A PERMIT

In Columbia County one permit will cover all trades doing work at the permitted site. It is **REQUIRED** that we have records of the subcontractors who actually did the trade specific work under the permit. Per Florida Statute 440 and Ordinance 89-6, a contractor shall require all subcontractors to provide evidence of workers' compensation or exemption, general liability insurance and a valid Certificate of Competency license in Columbia County.

Any changes, the permitted contractor is responsible for the corrected form being submitted to this office prior to the start of that subcontractor beginning any work. Violations will result in stop work orders and/or fines.

ELECTRICAL	Print Name <u>Mike Conner</u> License #: <u>ER13013192</u>	Signature <u>Michael S Conner</u> Phone #: <u>386-758-2233</u>
MECHANICAL/ A/C	Print Name _____ License #: _____	Signature _____ Phone #: _____
PLUMBING/ GAS	Print Name _____ License #: _____	Signature _____ Phone #: _____
ROOFING	Print Name _____ License #: _____	Signature _____ Phone #: _____
SHEET METAL	Print Name _____ License #: _____	Signature _____ Phone #: _____
FIRE SYSTEM/ SPRINKLER	Print Name _____ License #: _____	Signature _____ Phone #: _____
SOLAR	Print Name _____ License #: _____	Signature _____ Phone #: _____

Specialty License	License Number	Sub-Contractors Printed Name	Sub-Contractors Signature
MASON			
CONCRETE FINISHER			
FRAMING			
INSULATION			
STUCCO			
DRYWALL			
PLASTER			
CABINET INSTALLER			
PAINTING			
ACOUSTICAL CEILING			
GLASS			
CERAMIC TILE			
FLOOR COVERING			
ALUM/VINYL SIDING			
GARAGE DOOR			
METAL BLDG ERECTOR			

F. S. 440.103 Building permits; identification of minimum premium policy.—Every employer shall, as a condition to applying for and receiving a building permit, show proof and certify to the permit issuer that it has secured compensation for its employees under this chapter as provided in ss. 440.10 and 440.38, and shall be presented each time the employer applies for a building permit.

03/24/2010 15:13 3867582160

BUILDING AND ZONING

SUBCONTRACTOR VERIFICATION FORM

APPLICATION NUMBER 1003-50 CONTRACTOR Gary Newsome PHONE 386-772-2315
THIS FORM MUST BE SUBMITTED PRIOR TO THE ISSUANCE OF A PERMIT

In Columbia County one permit will cover all trades doing work at the permitted site. It is **REQUIRED** that we have records of the subcontractors who actually did the trade specific work under the permit. Per Florida Statute 440 and Ordinance 89-6, a contractor shall require all subcontractors to provide evidence of workers' compensation or exemption, general liability insurance and a valid Certificate of Competency license in Columbia County.

Any changes, the permitted contractor is responsible for the corrected form being submitted to this office prior to the start of that subcontractor beginning any work. Violations will result in stop work orders and/or fines.

ELECTRICAL	Print Name: <u>Mike Conner</u>	Signature: _____	Phone #: _____
	License #: <u>ER13013192</u>		Phone #: <u>386-758-2233</u>
MECHANICAL/A/C	Print Name: <u>Clinton G. Wilson</u>	Signature: <u>Clinton G. Wilson</u>	Phone #: _____
	License #: <u>CAC057886</u>		Phone #: <u>386-496-9000</u>
PLUMBING/GAS	Print Name: _____	Signature: _____	Phone #: _____
	License #: _____		Phone #: _____
ROOFING	Print Name: _____	Signature: _____	Phone #: _____
	License #: _____		Phone #: _____
SHEET METAL	Print Name: _____	Signature: _____	Phone #: _____
	License #: _____		Phone #: _____
FIRE SYSTEM/SPRINKLER	Print Name: _____	Signature: _____	Phone #: _____
	License #: _____		Phone #: _____
SOLAR	Print Name: _____	Signature: _____	Phone #: _____
	License #: _____		Phone #: _____

Specialty Category	License Number	Sub-Contractor Name	Signature
MASON			
CONCRETE FINISHER			
FRAMING			
INSULATION			
STUCCO			
DRYWALL			
PLASTER			
CABINET INSTALLER			
PAINTING			
ACOUSTICAL CEILING			
GLASS			
CERAMIC TILE			
FLOOR COVERING			
ALUM/VINYL SIDING			
GARAGE DOOR			
METAL BLDG ERECTOR			

F. S. 440.103 Building permits; identification of minimum premium policy.—Every employer shall, as a condition to applying for and receiving a building permit, show proof and certify to the permit issuer that it has secured compensation for its employees under this chapter as provided in ss. 440.10 and 440.38, and shall be presented each time the employer applies for a building permit.

Contractor Form: Subcontractor Form: 4/09

App 1003-50

Inst. 201012005725 Date: 4/12/2010 Time: 3:12 PM
DC, P. DeWitt Cason, Columbia County Page 1 of 1 B. 1192 P. 1328

NOTICE OF COMMENCEMENT

County Clerk's Office Stamp or Seal

Tax Parcel Identification Number 01-45-16-02662-000

THE UNDERSIGNED hereby gives notice that improvements will be made to certain real property, and in accordance with Section 713.13 of the Florida Statutes, the following information is provided in this NOTICE OF COMMENCEMENT.

- 1. Description of property (legal description): Comm NW Cor of SE 1/4 of NW 1/4 6.5 Acres
a) Street (job) Address: SW Cardinal Place Lake City FL
- 2. General description of improvements: installation of 3 modulars for private school
- 3. Owner Information
a) Name and address: Pamela Steele 5584 150th Pl Wellborn FL 32094
b) Name and address of fee simple titleholder (if other than owner) _____
c) Interest in property owner
- 4. Contractor Information
a) Name and address: Gary Newsome 3792 NW Hwy 41 Jennings FL
b) Telephone No.: 386-792-2315 Fax No. (Opt.) _____
- 5. Surety Information
a) Name and address: N/A
b) Amount of Bond: _____
c) Telephone No.: _____ Fax No. (Opt.) _____
- 6. Lender
a) Name and address: N/A
b) Phone No. _____
- 7. Identity of person within the State of Florida designated by owner upon whom notices or other documents may be served:
a) Name and address: N/A
b) Telephone No.: _____ Fax No. (Opt.) _____
- 8. In addition to himself, owner designates the following person to receive a copy of the Lienor's Notice as provided in Section 713.13(1)(b) Florida Statutes:
a) Name and address: _____
b) Telephone No.: _____ Fax No. (Opt.) _____
- 9. Expiration date of Notice of Commencement (the expiration date is one year from the date of recording unless a different date is specified): _____

WARNING TO OWNER: ANY PAYMENTS MADE BY THE OWNER AFTER THE EXPIRATION OF THE NOTICE OF COMMENCEMENT ARE CONSIDERED IMPROPER PAYMENTS UNDER CHAPTER 713, PART I, SECTION 713.13, FLORIDA STATUTES, AND CAN RESULT IN YOUR PAYING TWICE FOR IMPROVEMENTS TO YOUR PROPERTY; A NOTICE OF COMMENCEMENT MUST BE RECORDED AND POSTED ON THE JOB SITE BEFORE THE FIRST INSPECTION. IF YOU INTEND TO OBTAIN FINANCING, CONSULT YOUR LENDER OR AN ATTORNEY BEFORE COMMENCING WORK OR RECORDING YOUR NOTICE OF COMMENCEMENT.

STATE OF FLORIDA
COUNTY OF COLUMBIA

10. Pam Steele
Signature of Owner or Owner's Authorized Office/Director/Partner/Manager
Pam Steele
Print Name

The foregoing instrument was acknowledged before me, a Florida Notary, this 8 day of April, 2010, by:
Pam Steele as owner (type of authority, e.g. officer, trustee, attorney fact) for _____ (name of party on behalf of whom instrument was executed).

Personally Known _____ OR Produced Identification Type FL DL

Notary Signature Shirley M Bennett Notary Stamp or Seal:



11. Verification pursuant to Section 92.525, Florida Statutes. Under penalties of perjury, I declare that I have read the foregoing and that the facts stated in it are true to the best of my knowledge and belief.

Pam Steele
Signature of Natural Person Signing (in line #10 above.)



**SUWANNEE
RIVER
WATER
MANAGEMENT
DISTRICT**

9225 CR 49
LIVE OAK, FLORIDA 32060
TELEPHONE: (386) 362-1001
TELEPHONE: 800-226-1066
FAX (386) 362-1056

NOTICED GENERAL PERMIT

PERMITTEE:
PAMELA STEELE & JANET BALLANCE
222 SW CARDINAL PLACE
LAKE CITY, FL 32025

PERMIT NUMBER: ERP10-0065
DATE ISSUED: 04/16/2010
DATE EXPIRES: 04/16/2013
COUNTY: COLUMBIA
TRS: S1/T4S/R16E

PROJECT: STEELE & BALLANCE PRIVATE SCHOOL

Approved entity to whom operation and maintenance may be transferred pursuant to rule 40B-4.1130, Florida Administrative Code (F.A.C.):

PAMELA STEELE & JANET BALLANCE
222 SW CARDINAL PLACE
LAKE CITY, FL 32025

Based on information provided, the Suwannee River Water Management District's (District) rules have been adhered to and an environmental resource noticed general permit is in effect for the permitted activity description below:

Construction and operation of a surfacewater management system serving 3892.00 square feet of impervious surface consisting of three modular buildings on a total project area of 1.15 acres in a manner consistent with the application package submitted by Wendy Grennell.

It is your responsibility to ensure that adverse off-site impacts do not occur either during or after construction. Any additional construction or alterations not authorized by this permit may result in flood control or water quality problems both on and off site and will be a violation of District rule.

You or any other substantially affected persons are entitled to request an administrative hearing or mediation. Please refer to enclosed notice of rights.

This permit is issued under the provisions of chapter 373, F.S., chapter 40B-4, and chapter 40B-400, F.A.C. A noticed general permit authorizes the construction, operation, maintenance, alteration,

Permit No.: ERP10-0065

Project: STEELE & BALLANCE PRIVATE SCHOOL

Page 2 of 7

abandonment, or removal of certain minor surface water management systems. This permit authorizes the permittee to perform the work necessary to construct, operate, and maintain the surface water management system shown on the application and other documents included in the application. This is to notify you of District's agency action concerning Notice Of Intent. This action is taken pursuant to rule 40B-4 and 40B-400, F.A.C.

General Conditions for All Noticed General Permits:

1. The terms, conditions, requirements, limitations, and restrictions set forth in this section are general permit conditions and are binding upon the permittee for all noticed general permits in Part II of this chapter. These conditions are enforceable under Part IV of chapter 373, F.S.
2. The general permit is valid only for the specific activity indicated. Any deviation from the specified activity and the conditions for undertaking that activity shall constitute a violation of the permit. A violation of the permit is a violation of Part IV of chapter 373, F.S., and may result in suspension or revocation of the permittee's right to conduct such activity under the general permit. The District may also begin legal proceedings seeking penalties or other remedies as provided by law for any violation of these conditions.
3. This general permit does not eliminate the necessity to obtain any required federal, state, local and special District authorizations prior to the start of any construction, alteration, operation, maintenance, removal or abandonment authorized by this permit.
4. This general permit does not convey to the permittee or create in the permittee any property right, or any interest in real property, nor does it authorize any entrance upon or activities on property which is not owned or controlled by the permittee, or convey any rights or privileges other than those specified in the general permit and Part II of this chapter.
5. This general permit does not relieve the permittee from liability and penalties when the permitted activity causes harm or injury to human health or welfare, animal, plant or aquatic life, or property. It does not allow the permittee to cause pollution in contravention of Florida Statutes and District rules.
6. The permittee is hereby advised that s.253.77, F.S., states that a person may not commence any excavation, construction or other activity involving the use of sovereign or other lands of the state, the title to which is vested in the Board of Trustees of the Internal Improvement Trust Fund without obtaining the required lease, license, easement, or other form of consent authorizing the proposed use. Therefore, the permittee is responsible for obtaining any necessary authorizations from the Board of Trustees prior to commencing activity on sovereignty lands or other state-owned lands.

Permit No.: ERP10-0065

Project: STEELE & BALLANCE PRIVATE SCHOOL

Page 3 of 7

7. The authorization to conduct activities pursuant to general permit may be modified, suspended or revoked in accordance with chapter 120, and s.373.429, F.S.

8. This permit shall not be transferred to a third party except pursuant to s.40B-4.1130, F.A.C. The permittee transferring the general permit shall remain liable for any corrective actions that may be required as a result of any permit violations prior to sale, conveyance, or other transfer of ownership or control of the permitted system or the real property at which the permitted system is located.

9. Upon reasonable notice to the permittee, District staff with proper identification shall have permission to enter, inspect, sample and test the permitted system to insure conformity with the plans and specifications approved by the permit.

10. The permittee shall maintain any permitted system in accordance with the plans submitted to the District and authorized by this general permit.

11. A permittee's right to conduct a specific noticed activity under this noticed general permit is authorized for the duration on the front of this permit.

12. Construction, alteration, operation, maintenance, removal and abandonment approved by this general permit shall be conducted in a manner which does not cause violations of state water quality standards, including any antidegradation provisions of s.62-4.242(1)(a) and (b), 62-4.242(2) and (3), and 62-302.300, F.A.C., and any special standards for Outstanding Florida Waters and Outstanding National Resource Waters. The permittee shall implement best management practices for erosion, turbidity and other pollution control to prevent violation of state water quality standards. Temporary erosion control measures such as sodding, mulching, and seeding shall be implemented and shall be maintained on all erodible ground areas prior to and during construction. Permanent erosion control measures such as sodding and planting of wetland species shall be completed within seven days of any construction activity. Turbidity barriers shall be installed and maintained at all locations where the possibility of transferring suspended solids into wetlands or other surface waters exists due to the permitted activity. Turbidity barriers shall remain in place and shall be maintained in a functional condition at all locations until construction is completed and soils are stabilized and vegetation has been established. Thereafter the permittee shall be responsible for the removal of the barriers. The permittee shall correct any erosion or shoaling that causes adverse impacts to the water resources.

13. The permittee shall hold and save the District harmless from any and all damages, claims or liabilities which may arise by reason of the construction, alteration, operation, maintenance, removal, abandonment or use of any system authorized by the general permit.

14. The permittee shall immediately notify the District in writing of any previously submitted

Permit No.: ERP10-0065

Project: STEELE & BALLANCE PRIVATE SCHOOL

Page 4 of 7

information that is later discovered to be inaccurate.

15. The permittee shall perform all construction authorized in a manner so as to minimize adverse impacts to fish, wildlife, natural environmental values, and water quality. The permittee shall institute necessary measures during construction including riprap, reinforcement, or compaction of any fill materials placed around newly installed structures, to minimize erosion, turbidity, nutrient loading, and sedimentation in the receiving waters.

16. The permit is issued based on the information submitted by the applicant which reasonably demonstrates that adverse off-site water resource impacts will not be caused by the permitted activity. It is the responsibility of the permittee to insure that such adverse impacts do not in fact occur either during or after construction.

WITHIN 30 DAYS AFTER COMPLETION OF THE PROJECT, THE PERMITTEE SHALL NOTIFY THE DISTRICT, IN WRITING, THAT THE FACILITIES ARE COMPLETE.

Approved by James Link Date Approved April 16, 2010
District Staff



NOTICE OF RIGHTS

1. A person whose substantial interests are or may be determined has the right to request an administrative hearing by filing a written petition with the Suwannee River Water Management District (District), or may choose to pursue mediation as an alternative remedy under Section 120.569 and 120.573, Florida Statutes, before the deadline for filing a petition. Choosing mediation will not adversely affect the right to a hearing if mediation does not result in a settlement. The procedures for pursuing mediation are set forth in Sections 120.569 and 120.57 Florida Statutes. Pursuant to Rule 28-106.111, Florida Administrative Code, the petition must be filed at the office of the District Clerk at District Headquarters, 9225 C.R. 49, Live Oak, Florida 32060 within twenty-one (21) days of receipt of written notice of the decision or within twenty-one (21) days of newspaper publication of the notice of District decision (for those persons to whom the District does not mail actual notice). A petition must comply with Chapter 28-106, Florida Administrative Code.
2. If the Governing Board takes action which substantially differs from the notice of District decision to grant or deny the permit application, a person whose substantial interests are or may be determined has the right to request an administrative hearing or may chose to pursue mediation as an alternative remedy as described above. Pursuant to Rule 28-106.111, Florida Administrative Code, the petition must be filed at the office of the District Clerk at District Headquarters, 9225 C.R. 49, Live Oak, Florida 32060 within twenty-one (21) days of receipt of written notice of the decision or within twenty-one (21) days of newspaper publication of the notice of District decision (for those persons to whom the District does not mail actual notice). Such a petition must comply with Chapter 28-106, Florida Administrative Code.
3. A substantially interested person has the right to a formal administrative hearing pursuant to Section 120.569 and 120.57(1), Florida Statutes, where there is a dispute between the District and the party regarding an issue of material fact. A petition for formal hearing must comply with the requirements set forth in Rule 28-106.201, Florida Administrative Code.
4. A substantially interested person has the right to an informal hearing pursuant to Section 120.569 and 120.57(2), Florida Statutes, where no material facts are in dispute. A petition for an informal hearing must comply with the requirements set forth in Rule 28-106.301, Florida Administrative Code.
5. A petition for an administrative hearing is deemed filed upon receipt of the petition by the Office of the District Clerk at the District Headquarters in Live Oak, Florida.
6. Failure to file a petition for an administrative hearing within the requisite time frame shall constitute a waiver of the right to an administrative hearing pursuant to Rule 28-106.111, Florida Administrative Code.

Permit No.: ERP10-0065

Project: STEELE & BALLANCE PRIVATE SCHOOL

Page 6 of 7

7. The right to an administrative hearing and the relevant procedures to be followed is governed by Chapter 120, Florida Statutes, and Chapter 28-106, Florida Administrative Code.
8. Pursuant to Section 120.68, Florida Statutes, a person who is adversely affected by final District action may seek review of the action in the District Court of Appeal by filing a notice of appeal pursuant to the Florida Rules of Appellate Procedure, within 30 days of the rendering of the final District action.
9. A party to the proceeding before the District who claims that a District order is inconsistent with the provisions and purposes of Chapter 373, Florida Statutes, may seek review of the order pursuant to Section 373.114, Florida Statutes, by the Florida Land and Water Adjudicatory Commission, by filing a request for review with the Commission and serving a copy of the Department of Environmental Protection and any person named in the order within 20 days of adoption of a rule or the rendering of the District order.
10. For appeals to the District Courts of Appeal, a District action is considered rendered after it is signed on behalf of the District, and is filed by the District Clerk.
11. Failure to observe the relevant time frames for filing a petition for judicial review, or for Commission review, will result in waiver of the right to review.

CERTIFICATE OF SERVICE

I hereby certify that a copy of the foregoing Notice of Rights has been sent by U.S. Mail to:

PAMELA STEELE & JANET BALLANCE
222 SW CARDINAL PLACE
LAKE CITY, FL 32025

At 4:00 p.m. this 16 day of April, 2010.



Jon M. Dinges
Deputy Clerk
Suwannee River Water Management District
9225 C.R. 49
Live Oak, Florida 32060

Permit No.: ERP10-0065

Project: STEELE & BALLANCE PRIVATE SCHOOL

Page 7 of 7

386.362.1001 or 800.226.1066 (Florida only)

cc: File Number: ERP10-0065

ENERGY EFFICIENCY CODE FOR BUILDING CONSTRUCTION

Florida Department of Community Affairs

Energy Gauge FlaCom v1.21 FORM 400A-2001

Whole Building Performance Method for Commercial Buildings

Jurisdiction: CITRUS COUNTY, CITRUS COUNTY, FL (191000)

Short Desc: CUSTOM CRAFT

Project: 1915-1823

Owner: CUSTOM CRAFT

Cont. Newsome

Address: ---

City: Crystal River

PermitNo: 0-- *28530*

State: FL-

Storeys: 1

Zip: 0

GrossArea: 801

Type: School (educational)

Net Area: 801

Class: New Finished building

227000

Compliance Summary

<u>Component</u>	<u>Design</u>	<u>Criteria</u>	<u>Result</u>
Gross Energy Use	72.66	100.00	PASSES
Other Envelope Requirements - A			PASSES
LIGHTING CONTROLS			PASSES
EXTERNAL LIGHTING			PASSES
HVAC SYSTEM			PASSES
PLANT			PASSES
WATER HEATING SYSTEMS			PASSES
PIPING SYSTEMS			PASSES
Met all required compliance from Check List?			Yes/No/NA

REVIEWED
 FOR COMPLIANCE WITH CODES STATED ON PLANS
 JAN 22 2003
 HILBORN, WERNER, CARTER & ASSOCIATES, INC.
 HWC

Project: CUSTOM CRAFT
 Title: 1915-1823
 Type: School (educational)
 Location: CITRUS COUNTY, CITRUS COUNTY, FL (191000)
 (WEA File: Tampa.tmy)

Whole Building Compliance

	Design	Reference
Total	72.66	100.00

ELECTRICITY	72.66	100.00
AREA LIGHTS	8.84	9.81
MISC EQUIPMT	2.47	2.47
SPACE COOL	14.91	20.45
SPACE HEAT	12.66	13.26
VENT FANS	33.78	54.01

Credits & Penalties (if any): Modified Points: = 72.66

PASSES

Project: CUSTOM CRAFT
 Title: 1915-1823
 Type: School (educational)
 Location: CITRUS COUNTY, CITRUS COUNTY, FL (191000)
 (WEA File: Tampa.tmy)

Other Envelope Requirements

Item	Zone	Description	Design	Limit	Meet Req.
ROOF	1915-1823	Exterior Roof - Max Uo Limit	0.04	0.09	Yes

Meets Other Envelope Requirements

Project: CUSTOM CRAFT
 Title: 1915-1823
 Type: School (educational)
 Location: CITRUS COUNTY, CITRUS COUNTY, FL
 (191000)
 (WEA File: Tampa.tmy)

External Lighting Compliance

Desc	Category	Allowance (W/Unit)	Area or Length	ELPA (W)	CLP (W)
Ext Light 1	Entrance (without Canopy)	30.00	12.0	360	60
Ext Light 2	Exit (with or without Canopy)	25.00	12.0	300	60

Design: 120 (W)
 Allowance: 660 (W)

PASSES

Project: CUSTOM CRAFT
 Title: 1915-1823
 Type: School (educational)
 Location: CITRUS COUNTY, CITRUS COUNTY, FL (191000)
 (WEA File: Tampa.tmy)

Lighting Controls Compliance

Acronym	Ash- rae ID	Description	Area (sq.ft)	No. of Tasks	Design CP	Min CP	Compli- ance
Classroom	3	Classroom/Lecture Hall	801	2	3	3	PASSES

PASSES

Project: CUSTOM CRAFT
 Title: 1915-1823
 Type: School (educational)
 Location: CITRUS COUNTY, CITRUS COUNTY, FL (191000)
 (WEA File: Tampa.tmy)

System Report Compliance

1915-1823 System 1

Packaged Terminal Systems

Component	Category	Capa- city	Design Eff	Eff Criteria	Design IPLV	IPLV Criteria	Compli- ance
Cooling System	PTAC > 15000 Cooling Mode	36000	10.00	7.60			PASSES
Heating System	Electric Furnace	34100	1.00	1.00			PASSES
Air Handling System -Supply	Air Handler (Supply) - Constant Volume	3015	0.50	0.80			PASSES
Air Distribution System	ADS System		6.00	6.00			PASSES

PASSES

Plant Compliance								
Description	Installed No	Design Size	Design Eff	Min Eff	Design IPLV	Min IPLV	Category	Compliance
							None	

Water Heater Compliance							
Desc	Type	Category	Design Eff	Min Eff	Design Loss	Max Loss	Compliance

Piping System Compliance							
Category	Pipe Dia [inches]	Is Runout	Operat Temp [F]	Ins Cond Btu-in/h r.SF.F	Ins Thick [in]	Req Ins Thick [in]	Compliance

Project: CUSTOM CRAFT
 Title: 1915-1823
 Type: School (educational)
 Location: CITRUS COUNTY, CITRUS

Other Required Compliance

Category	Section	Requirement (write N/A in box if not applicable)	Check
Infiltration	406.1	Infiltration Criteria have been met	<input checked="" type="checkbox"/>
System	407.1	HVAC Load sizing has been performed	<input checked="" type="checkbox"/>
Ventilation	409.1	Ventilation criteria have been met	<input checked="" type="checkbox"/>
ADS	410.1	Duct sizing and Design have been performed	<input checked="" type="checkbox"/>
T & B	410.1	Testing and Balancing will be performed	N/A
Electrical	413.1	Metering criteria have been met	N/A
Motors	414.1	Motor efficiency criteria have been met	N/A
Lighting	415.1	Lighting criteria have been met	<input checked="" type="checkbox"/>
O & M	102.1	Operation/maintenance manual will be provided to owner	<input checked="" type="checkbox"/>
Roof/Ceil	404.1	R-19 for Roof Deck with supply plenums beneath it	N/A

HEAT LOSS AND GAIN ANALYSIS

MANUFACTURER: CUSTOM CRAFT MFG.
 DESTINATION: CITRUS COUNTY, FL

PLAN NO. 1915-1823
 MFR'S ID. CCM-20030004

VARIABLES

TEMPERATURES (DEGREE F.)
 OUTSIDE SUMMER DB OS := 93
 INSIDE SUMMER DB IS := 75
 OUTSIDE WINTER DB OW := 34
 INSIDE WINTER DB IW := 68
 DESIGN GRAINS AT 50% RH DG := 51
 DAILY RANGE (DEGREE F.) DR := 18

OCCUPANT CONTENT OC := 25
 OUTSIDE AIR CFM/OCCUPANT OA := 15
 LIGHTING WATTAGE
 INCANDESCENT IL := 0
 FLOURESCENT FL := 1440
 (DO NOT INCLUDE BALLAST LOAD)

	GLASS AREA (SF)	GROSS WALL AREA (SF)	U-VALUES	
NORTH	N := 0	NW := 186	UG := 1.04	GLASS WALL
EAST	E := 0	EW := 282	UW := 0.09	
SOUTH	S := 0	SW := 186		
WEST	W := 15	WW := 282		
WOOD/METAL DOOR AREA		WD := 40	WU := 0.46	DOOR
GLASS/FRENCH DOOR AREA		GD := 0	GU := 1.10	DOOR
ROOF AREA		R := 839	RU := 0.05	ROOF
FLOOR AREA		F := 839	FU := 0.09	FLOOR
GLASS SHADING FACTOR		SF := 1.0		
EQUIPMENT LOAD (BTUH/SF)		EL := 1		

HEAT GAINS (COOLING LOADS)

SENSIBLE HEAT GAINS:

A. SOLAR RADIATION THROUGH GLASS:

NORTH SRN := N · 30 · SF
 EAST SRE := E · 44 · SF
 SOUTH SRS := S · 56 · SF
 WEST SRW := W · 158 · SF
 TOTAL SR := SRN + SRE + SRS + SRW SR = 2370

B. TRANSMISSION GAINS:

1. GLASS: GA := N + E + S + W GA = 15
 TG := GA · UG · (OS - IS) TG = 281
 2. DOORS: TWG := WD · WU · (OS - IS) TWG = 331
 TGD := GD · GU · (OS - IS) TGD = 0
 3. WALLS: FIND EQUIVALENT TEMPERATURE DIFFERENCE (ETD)
 TEMPERATURE CORRECTION: TC := OS - IS - 20
 DAILY RANGE CORRECTION: DRC := 0.5 · (20 - DR)
 ETD := TC + DRC
 ETD = -1

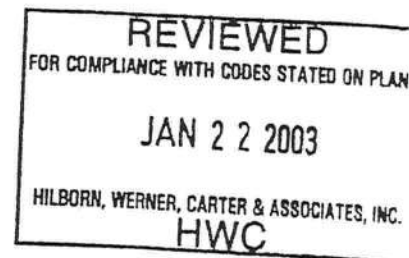

NORTH	TWN := (NW - N) · UW · (ETD + 15)		
EAST	TWE := (EW - E) · UW · (ETD + 36)		
SOUTH	TWS := (SW - S) · UW · (ETD + 23)		
WEST	TWW := (WW - W) · UW · (ETD + 17)		
TOTAL	TW := TWN + TWE + TWS + TWW	TW = 1875	
4. ROOF:	TR := R · RU · (OS - IS)	TR = 755	
5. FLOOR:	FR := F · FU · (OS - IS)	FR = 1359	
TOTAL TRANSMISSION GAIN	T := TG + TWG + TGD + TW + TR + FR	T = 4602	
C. OCCUPANTS:	SO := OC · 210	SO = 5250	
D. LIGHTS:	L := (IL · 3.4) + (FL · 4.1)	L = 5904	
E. VENTILATION:	SV := OC · OA · (OS - IS) · 1.1	SV = 7425	
F. DUCTS:	SD := (SR + T + SO + L + SV) · 0.05	SD = 1278	
G. EQUIPMENT:	EQ := EL · F	EQ = 839	
TOTAL SENSIBLE HEAT GAIN	SHG := SR + T + SO + L + SV + SD + EQ	SHG = 27667	
LATENT HEAT GAINS:			
A. OCCUPANTS:	LO := OC · 140	LO = 3500	
B. VENTILATION:	LV := OC · OA · DG · 0.68	LV = 13005	
TOTAL LATENT HEAT GAIN	LHG := LO + LV	LHG = 16505	
TOTAL HEAT GAIN	HG := SHG + LHG	HG = 44172	BTUH

HEAT LOSS (HEATING LOADS)

A. TRANSMISSION LOSS:			
1. GLASS:	LTG := GA · UG · (IW - OW)	LTG = 530	
2. DOORS:	LTWD := WD · WU · (IW - OW)	LTWD = 626	
	LTGD := GD · GU · (IW - OW)	LTGD = 0	
3. WALLS:	LTW := (NW + EW + SW + WW - GA) · UW · (IW - OW)	LTW = 2818	
4. ROOF:	LR := R · RU · (IW - OW)	LR = 1426	
5. FLOOR:	LF := F · FU · (IW - OW)	LF = 2567	
TOTAL TRANSMISSION LOSS	LT := LTG + LTWD + LTGD + LTW + LR + LF	LT = 7968	
B. DUCTS:	LD := LT · 0.05	LD = 398	
C. VENTILATION:	LV := OC · OA · (IW - OW) · 1.1	LV = 14025	
TOTAL HEAT LOSS	HL := LT + LD + LV	HL = 22391	BTUH

REFERENCE: ACCA MANUAL N
FOURTH EDITION

28530



COLUMBIA COUNTY FIRE RESCUE

P.O. BOX 1529 Lake City, Florida 32056
Office (386) 754-7071 Fax (386) 754-7064

Division Chief
David L. Boozer

27 May 2010

TO: A Plus Learning Academy
810 SW Faith Road
Lake City, Florida 32025

FROM: David L. Boozer
Division Chief / Fire Marshal

RE: Fire Safety Inspection

A Fire Safety Inspection was performed today of the A Plus Learning Academy, located at 810 Faith Road, Lake City, Florida 32025. At the time of my inspection the school meets the requirements as outlined in Chapter 14, of the Florida Fire Prevention Code, 2007 edition. I recommend approval.

Should you require any additional information, please feel free to contact my office.

Sincerely,

A handwritten signature in black ink that reads "David L. Boozer".

David L. Boozer

App # 1003-50

PRODUCT APPROVAL SPECIFICATION SHEET

Location: Cardinal Place

Project Name: Steele/Ballance

As required by Florida Statute 553.842 and Florida Administrative Code 9B-72, please provide the information and the product approval number(s) on the building components listed below if they will be utilized on the construction project for which you are applying for a building permit on or after April 1, 2004. We recommend you contact your local product supplier should you not know the product approval number for any of the applicable listed products. More information about statewide product approval can be obtained at www.floridabuilding.org

Category/Subcategory	Manufacturer	Product Description	Approval Number(s)
A. EXTERIOR DOORS			
(1) Swinging	Masonite	ext doors	FL-4242-R1
2. Sliding			
3. Sectional			
4. Roll up			
5. Automatic			
6. Other			
B. WINDOWS			
(1) Single hung	Esp	single hung insulated	FL 5768
2. Horizontal Slider			
3. Casement			
4. Double Hung			
5. Fixed			
6. Awning			
7. Pass-through			
8. Projected			
9. Mullion			
10. Wind Breaker			
11 Dual Action			
12. Other			
C. PANEL WALL			
1. Siding	Kay Can	vinyl-	FL 889-R2
2. Soffits	Kay Can	vinyl soffit	FL 4899
3. EIFS			
4. Storefronts			
5. Curtain walls			
6. Wall louver			
7. Glass block			
8. Membrane			
9. Greenhouse			
10. Other			
D. ROOFING PRODUCTS			
1. Asphalt Shingles	GAF/EIL	Architectural	FL 586-R2
2. Underlayments	Woodland	30 lb felt	FL 1814-R1
3. Roofing Fasteners	Simpson		FL 474-R1
4. Non-structural Metal Rf			
5. Built-Up Roofing			
6. Modified Bitumen			
7. Single Ply Roofing Sys			
8. Roofing Tiles			
9. Roofing Insulation			
10. Waterproofing			
11. Wood shingles /shakes			

MATERIAL SPECIFICATIONS

SOIL/ SITE PREPARATION

1. Foundation design is based on an allowable soil bearing pressure of 2000 PSF. Any soil conditions that may differ from that described shall be brought to the attention of the Architect/ Engineer prior to placement of the modular units.
2. Foundations shall be built on undisturbed soil or properly compacted fill material. Compacted soils shall be tested to a minimum of 95% of modified proctor in accordance with ASTM D 1557.
3. Excavations for foundations shall be backfilled with soil, which is free of organic material, construction debris, and larger rocks.
4. This Foundation design is specifically designed for this type of soil as per the Soil Report.

BASE PAD

1. Pier footing type base pad shall be a minimum 16"x18" ABS foundation pad as manufactured by the down engineering and shall have a minimum of 2.00 sq. ft. bearing capacity.
2. Concrete in footing shall have a specified compressive strength of no less than 2500 PSI (17.238 kPa) at 28 days.

MASONRY UNIT

1. Piers shall be constructed with normal 8"x8"x16" concrete masonry units conforming to ASTM C-90.

ALT. PIER- METAL STANDS

1. An acceptable alternate pier shall be the DP series MDP 16 through 32 deluxe mobile home pier as manufactured by Minute Man Anchors, Inc. or equal. Placement of piers on the required foundation base pad shall be as indicated on the plan and installation shall be per the manufacturer's written instructions.
- WOOD/ SHIM MATERIAL**
1. All wood blocking and shims shall be cedar or pressure treated.

INSTALLATION SPECIFICATIONS

SOIL/ SITE PREPARATION

1. Where water impacts the ground from a roof valley, down spout, scupper or other rainwater collection or diversion device, provisions shall be made to prevent soil erosion and direct the water away from the foundation.
 2. Finish grade shall be sloped away from the foundation for drainage. The area under footings, foundations and concrete slabs on grade shall have all vegetation, stumps, roots and foreign materials removed prior to their construction. Fill material shall be free of vegetation and foreign material.
- MASONRY UNIT**
1. Long dimension of all piers shall be installed perpendicular to the frame. Maximum four units high (32"); unless otherwise noted by engineer.
 2. Concrete masonry units shall conform to the ASTM C 90 standard.
 3. Construction of dry-stacked, surface-bonded masonry walls when specified, including stacking and leveling of units, mixing and application of mortar, curing and protection shall comply with ASTM C 946.

ALT. PIER- METAL STANDS

1. Placement of Piers on the required foundation base pad shall be as indicated on the plans and installation shall be per the manufacturer's written instructions.

THE DOWNS STRAPS

1. The first tie-down strap from the endwalls shall not exceed 2'-0".
2. Maximum tie-down spacing shall not exceed 5'-8" o.c.
3. Refer to the plan for the minimum number of required tie down anchors.

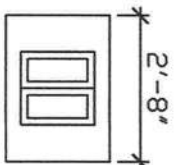

16x16 CMU STACK ON THREE STACKED ABS PADS TO PROVIDE 5.0 SF BEARING SURFACE
PIER REQUIRES 16"x16"x4" CONCRETE CAP OR BLOCK

PIER TYPE (B)

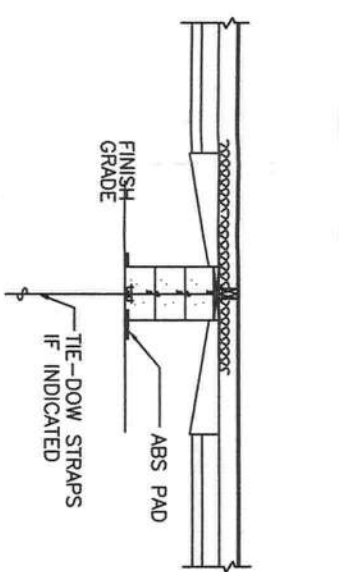

SECTION (D)

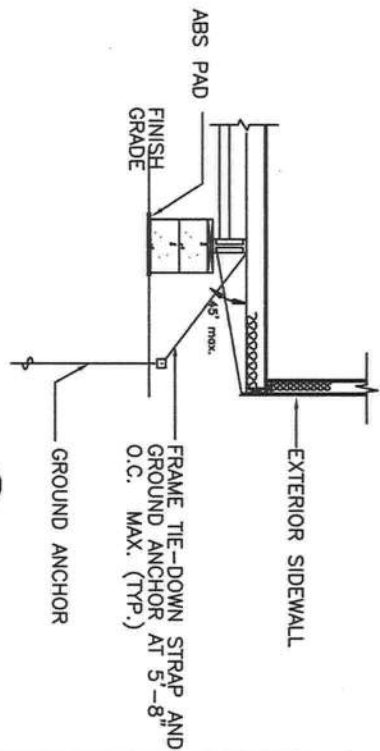

SECTION (A)

TIE-DOWN NOTE:
When a vertical Tie-Down Strap is provided as an integral part of a modular unit, the installer shall provide a frame tie at this location and install additional frame ties to achieve minimum tie-down spacing specified.

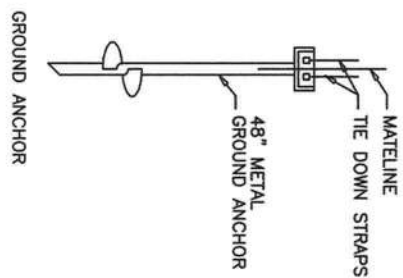

GROUND ANCHOR NOTE:

Stabilizer plates are not required with installation. However, any unstable soil conditions that may impact the ground anchor's ability to resist uplift shall be brought to the attention of the Architect/ Engineer for attention.

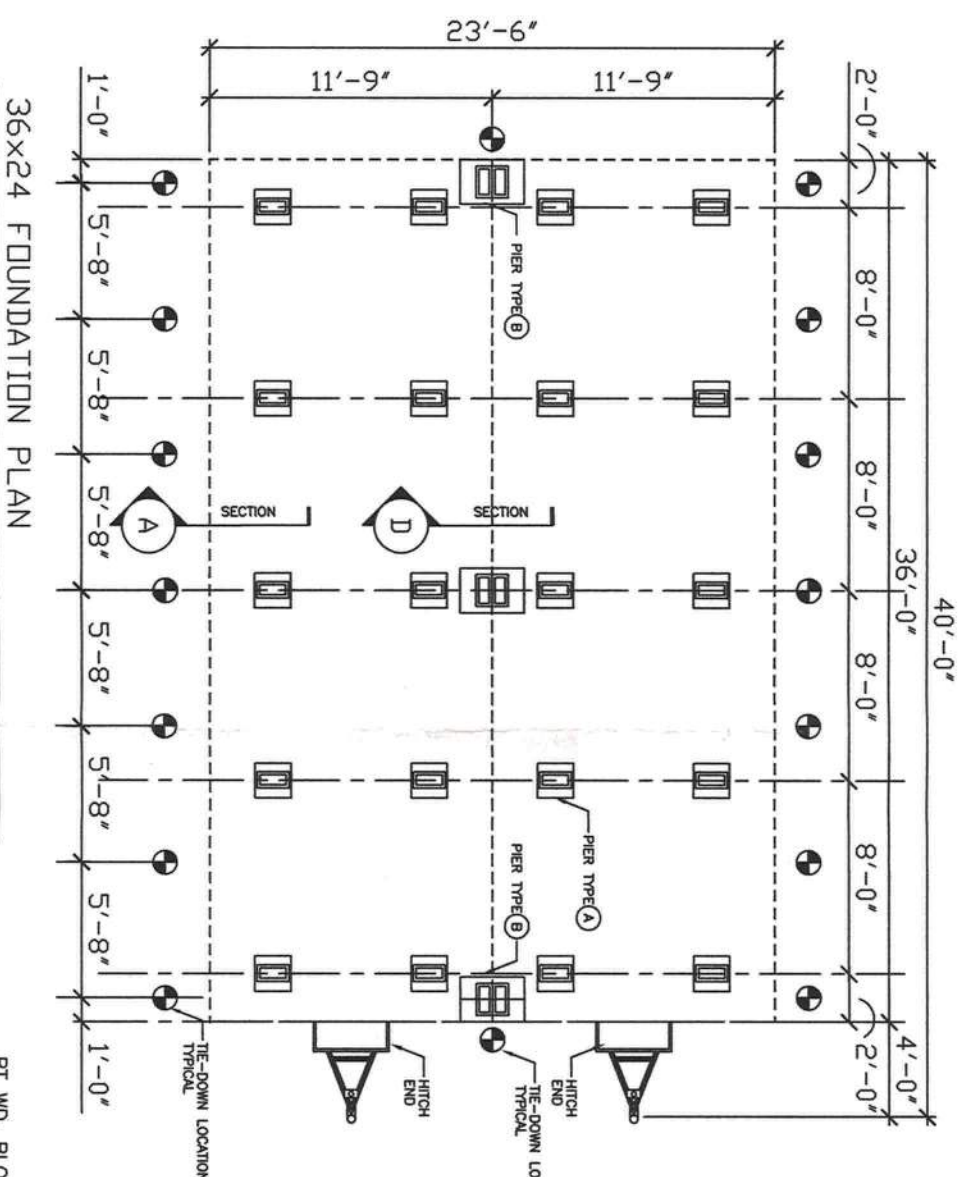

36x24 FOUNDATION PLAN
SCALE: 1/8" = 1'-0"

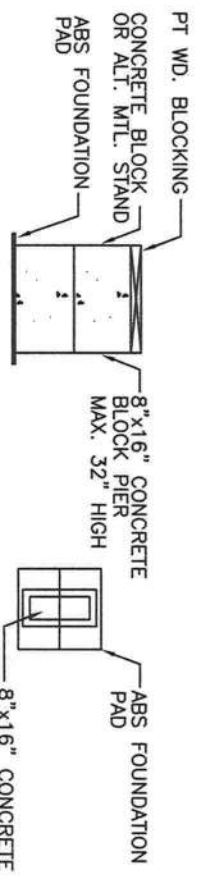

SECTION A
PIER TYPE (A)

PLAN A

COMPLIANCE STATEMENT
THE DETAILS PROVIDED IN THIS FOUNDATION PLAN FOR THIS CONSTRUCTION HAVE BEEN DESIGNED IN ACCORDANCE WITH 2007 and 09 supplements BUILDING CODE FOR DESIGN PRESSURES GENERATED BY A DESIGN WIND VELOCITY OF 130 MPH.

1. BASIC WIND SPEED 130 MPH
2. WIND IMPORTANCE FACTOR I=1.0: BUILDING CATEGORY II
3. WIND EXPOSURE: B
4. INTERNAL PRESSURE COEFFICIENT: +0.18
5. COMPONENTS AND CLADDING: +35.3PSF, -47.2 PSF

36x24 MOBILE OFFICE

JIM ERVIN... ARCHITECTURAL DESIGN SERVICE
9546 STARHAWK DRIVE, UNIT B
TALLAHASSEE, FL 32308
(904) 545-6035
FL. ARC. # 0011528

PRJ #	0310-291
DATE:	4/19/10
REVISION	
DRAWN BY:	GAF
REVIEWED BY:	
SCALE:	

DRAWING NO. **A1**
1 OF 1 DWGS.

Handwritten signature and date: 4/19/10

GENERAL NOTES: 2001 FBC
2000 NFPA 101

- THIS PLAN IS SUBJECT TO TECHNICAL REVIEW BY THE SCHOOL DISTRICT AND THE FLORIDA DEPARTMENT OF EDUCATION. CONSTRUCTION SHOULD NOT COMMENCE UNLESS THE BUILDING MANUFACTURER RECEIVES WRITTEN NOTIFICATION THAT THE TECHNICAL REVIEW IS COMPLETE AND ALL D.O.E. MANDATORIES (IF ANY) HAVE BEEN ADDRESSED AND SATISFIED.
- ALL BUILDING CONSTRUCTION MATERIALS, AND INSTALLATION MUST BE IN ACCORDANCE WITH THE 2001 FLORIDA BUILDING CODE (FBC) AND THE STATE REQUIREMENTS FOR EDUCATIONAL FACILITIES - 1997 SRF.
- THIS BUILDING MEETS THE STANDARD FOR EXISTING "SATISFACTORY" RELOCATABLE CLASSROOM BUILDINGS ASCRUBINED IN CHAPTER 5 OF THE 1999 SRF.
- HANDICAP ACCESS TO BUILDING IS FIELD DESIGNED, SUPPLIED AND SITE INSTALLED BY OTHERS AND IS SUBJECT TO THE APPROVAL OF THE D.O.E. ALL CIRCULATION (WALKWAYS, RAMPS, ETC.), SITE PREPARATION, UTILITIES, SURETIES, ETC., ARE TO BE DONE BY THE SCHOOL DISTRICT.
- MANUAL FIRE ALARM SYSTEM SHALL BE SITE DESIGNED, SUPPLIED AND SITE INSTALLED BY OTHERS AND IS SUBJECT TO THE APPROVAL OF THE D.O.E.
- ALL WINDOWS WITHIN 48 INCHES OF DOORS, AND ALL GLASS DOORS SHALL BE SAFETY OR TEMPERED GLASS.
- FLOOR DESIGN LIVE LOAD: 80 PSF (LOBBIES & CORRIDORS); 40 PSF (CLASSROOMS)
- WIND SPEED: 130 MPH x 1.1 IMPORTANCE FACTOR, PER ASCE 7-98; EXP-B, CAT.-1.
- OCCUPANCY: EDUCATIONAL OCCUPANCY = 49 (CALCULATED).

- BUILDING CONSTRUCTION: TYPE VI (FBC).
- ALL EGRESS DOORS PROVIDED WITH HARDWARE WHICH WILL ALLOW EGRESS AT ALL TIMES WITHOUT ASSISTANCE. DOORS PROVIDED WITH LOCKS SHALL BE EQUIPPED WITH LOCKSETS WHICH ARE NOT LOCKABLE FROM THE INSIDE OF THE SPACE AND ARE CLASSROOM FUNCTION LOCKSETS. TOILET ROOM DOORS MAY HAVE PRIVACY LOCKS, BUT SUCH LOCKS SHALL BE UNLOCKABLE FROM THE OUTSIDE WITHOUT THE USE OF A SPECIAL KEY, WRENCH, OR SPECIALIZED OBJECT.
- OPERABLE GLAZING AND THE AREA OF EXTERIOR DOORS, TOGETHER, SHALL CONSIST OF AT LEAST FIVE (5) PERCENT OF THE FLOOR AREA AS PER F.S. 233.212 - CALCULATED AT 54 S.F.
- INTERIOR WALL AND CEILING FINISHES SHALL BE CLASS A OR CLASS B AS DEFINED BY NFPA 101. FORMALDEHYDE LEVELS SHALL NOT EXCEED THE MINIMUM HUD STANDARDS FOR MANUFACTURED HOUSING.
- FLOORS SHALL BE COVERED WITH RESILIENT MATERIAL, CARPET OR OTHER FINISHED PRODUCT. CARPET SHALL BE TESTED AND CERTIFIED BY THE MANUFACTURER AS PASSING THE RADIANT PANEL TEST CLASS II.
- TOILET ROOM FLOORS AND BASE SHALL BE FINISHED WITH IMPERVIOUS MATERIALS WHICH SHALL BE EXTENDED TO A MINIMUM HEIGHT OF SIX (6) FEET. CEILING SHALL BE SOLID TYPE MOISTURE RESISTANT MATERIALS.
- EMERGENCY RESCUE WINDOWS SHALL COMPLY WITH NFPA 101, AND SHALL BE LABELED "EMERGENCY RESCUE - KEEP AREA CLEAR" WHEN A SECONDARY EXIT DOOR IS PROVIDED IN LIEU OF AN EMERGENCY RESCUE WINDOW, A PROMINENTLY DISPLAYED SIGN STATING "EMERGENCY EGRESS" SHALL BE PROVIDED ADJACENT TO THE DOOR.
- DOCUMENT STORAGE SHALL BE PROVIDED TO SECURELY STORE THE FOUNDATION PLAN AND ANNUAL FIRE INSPECTION REPORT WITHIN THE UNIT.
- ALL PRODUCTS USED IN THE CONSTRUCTION SHALL BE ASSESSORS FREE.
- CHILD CARE/DAY CARE USE SHALL ALSO BE REQUIRED TO MEET THE ADDITIONAL CRITERIA UNDER THE "CHILD CARE/DAY CARE/PREKINDERGARTEN FACILITIES" FOR TEMPORARY BUILDINGS CONTAINED IN SRF.
- ALL STEEL STRAPS REFERENCED ON FLOOR PLAN SHALL BE 1/2 INCH x 25 GA. W/ (7) 14 GA. x 7/16 INCH CROWN x 1 INCH STAPLES EACH END OF STRAP OR EQUIVALENT FROM RIDGE BEAM TO COLUMN, AND COLUMN TO FLOOR.
- MINIMUM CORRIDOR WIDTH IS 44 INCHES.
- MINIMUM CORRIDOR FINISH IS CLASS B (GYPSUM).
- WINDOW AND DOOR HIGH WIND STORM COVERINGS PER CODE TO BE SUPPLIED AND SITE INSTALLED BY OTHERS SUBJECT TO LOCAL JURISDICTION AND APPROVAL.
- SITE INSTALLED BY OTHERS SUBJECT TO LOCAL JURISDICTION AND APPROVAL.
- PLAN REVIEW AND INSPECTION REQUIRED BY CHAPTER 633 F.S. TO BE DONE BY LOCAL FIRE SAFETY INSPECTOR.

STANDARDS FOR FACTORY BUILT SCHOOL BUILDINGS - "TEMPORARY FACILITIES"

BASIS OF EVALUATION

- Chapter 5, State Requirements for Educational Facilities, 1999 Edition
- Type VI Construction Based on S.R.F., 1997 Edition
- Department of Community Affairs Emergency Rules
- Rule 98-1002 Definitions
- Rule 98-1004 Adoption of Model Codes
- Rule 98-1028 Factory-built Schools, Certifications and Work Progress Reports
- Rule 98-1028 Factory-built Schools, Inspections and Data Plate
- Rule 98-1030 Factory-built Schools, Inspectio and Data Plate

CURRENT REFERENCED CODES (As of June 1, 2002)

- 2001 FLORIDA BUILDING CODE
- 2001 FLORIDA MECHANICAL CODE
- 2001 FLORIDA PLUMBING CODE
- 2000 NFPA 101 LIFE SAFETY CODE
- 1999 NATIONAL ELECTRIC CODE

ACCESSIBILITY

Factory built schools shall comply with the Americans with Disabilities Act as modified by Chapter 553 F.S., and the Florida Accessibility Code for Building Construction, Latest Edition.

FLOODPLAIN

Units located within a one hundred (100) year floodplain shall have the finished floor at least (12) inches above the base flood elevation and anchored to resist buoyant forces.

COVERED WALKS AND TECHNOLOGY

Units intended for long-term use, shall be connected from exit door to the core facilities by accessible covered walkways. Units shall contain wiring and computer technologies connected to the facility's technology, communication and fire alarm infrastructure.

UNIT SETBACKS

The minimum setback from the property lines shall be as required by local zoning.

UNIT SEPARATION AND PLACEMENT

Type VI units shall be separated from each other and any permanent buildings as required by the state minimum building code and the school site plan. Consult with local fire authority for fire code site requirements.

FOUNDATION DESIGN

Foundations shall meet the state minimum building code for wind uplift, and overturning conditions, and load requirements for soil conditions as determined. New foundations shall comply with new construction requirements of the state minimum building code, and ASCE 7-98.

Type VI - Educational Classroom 24x36 Unit
1999 Edition of SRF
Department of Education - State of Florida

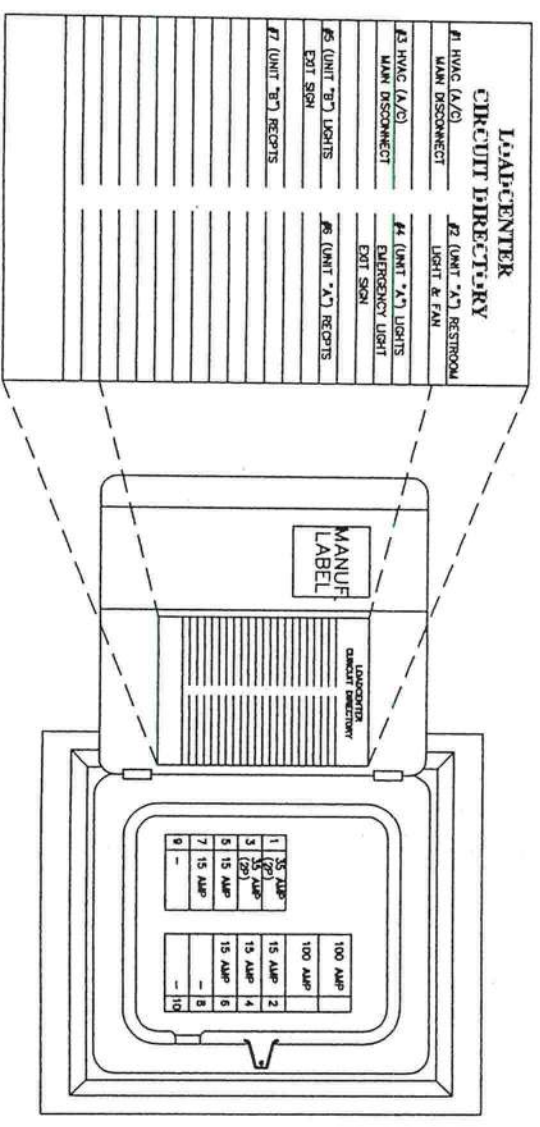

STRUCTURAL LOAD LIMITATIONS:

- FLOOR LIVE LOAD:
 - A. 40 PSF (LOBBIES & CORRIDORS)
 - B. 80 PSF (LOBBIES & CORRIDORS)
- ROOF LIVE LOAD:
 - A. 20 PSF
- ROOF SNOW LOAD: N/A
- WIND LOAD:
 - A. 130 MPH
 - B. W = 1.0
 - C. B
 - D. Gcpi = 0.18
- ROOF COMPONENT & CLADDING LOAD:
 - F. Pr = -76.80 PSF
 - G. Pw = -40.70 PSF
- WALL COMPONENT & CLADDING LOAD (WINDOWS/DOORS):
 - G. THIS BUILDING IS NOT DESIGNED FOR PLACEMENT ON THE UPPER HALF OF A HILL OR ESCARPMENT EXCEEDING 15 FEET IN HEIGHT.
- SEISMIC LOAD: N/A
- FLOOD LOAD: THIS BUILDING IS NOT DESIGNED TO BE LOCATED IN A FLOOD HAZARD AREA.

DRAWING INDEX:

SHEET 1 of 6	COVER SHEET
SHEET 2 of 6	FOUNDATION PLAN
SHEET 3 of 6	ELECTRICAL PLAN
SHEET 4 of 6	ELECTRICAL PLAN
SHEET 5 of 6	LIFE SAFETY PLAN
SHEET 6 of 6	BUILDING CROSS SECTION



TYPICAL SINGLE PANEL SERVICE

- NOTES:
- ALL ELECTRICAL MATERIALS AND CONSTRUCTION MUST BE IN ACCORDANCE WITH THE NATIONAL ELECTRIC CODE (NEC) NFPA 70.
 - LABORATORIES IN COMPLIANCE WITH LOCAL STANDARDS.
 - SERVICE DROP CLEARANCES ABOVE ROOF AND GROUND MUST COMPLY WITH SECTION 230-24 OF THE NEC WITHIN 5'-0" OF ATTIC ACCESS MUST BE INSTALLED PER SECTION 333-12 OF THE NEC.
 - WIRING TO BE FASTENED 4 FOOT O.C., 12 INCHES FROM METAL BOX & 8 INCHES FROM WALL.
 - ALL SITE INSTALLED ITEMS ARE DESIGNED BY OTHERS AND SUBJECT TO THE APPROVAL OF THE LOCAL JURISDICTION.

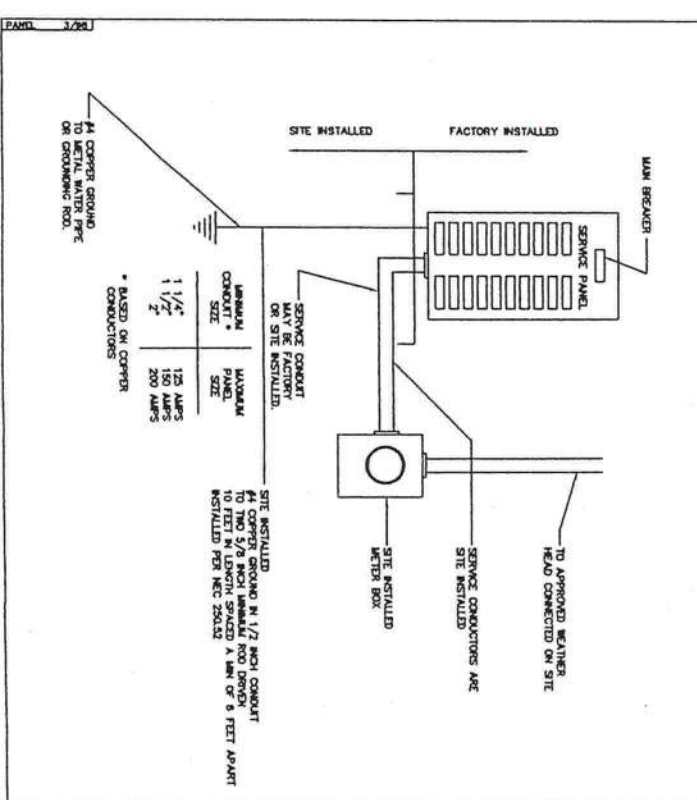

REV	DATE	BY	DESCRIPTION
1	1/20/03	WM	RE-CERTIFICATION

Custom Craft Mfg.
P.O. BOX 997
Zolfo Springs, FL 33890
(863) 735-0812

ELEC/HVAC PLAN

WJMA
WILLIAM J. McCANN, P.E.
1563 TURNER STREET
CLEARWATER, FL 33756
Ph: (727) 443-7860

REVIEWED
FOR COMPLIANCE WITH CODES STATED ON PLANS
JAN 22 2003
HILBORN, WERNER, CARTER & ASSOCIATES, INC.
HWC
UBC INSPECTIONS:
HILBORN, WERNER, CARTER & ASSOC., INC.
627 SOUTH WATKINS AVENUE
CLEARWATER, FLORIDA 33756

E/HI
FL P.E. LIC. #50252

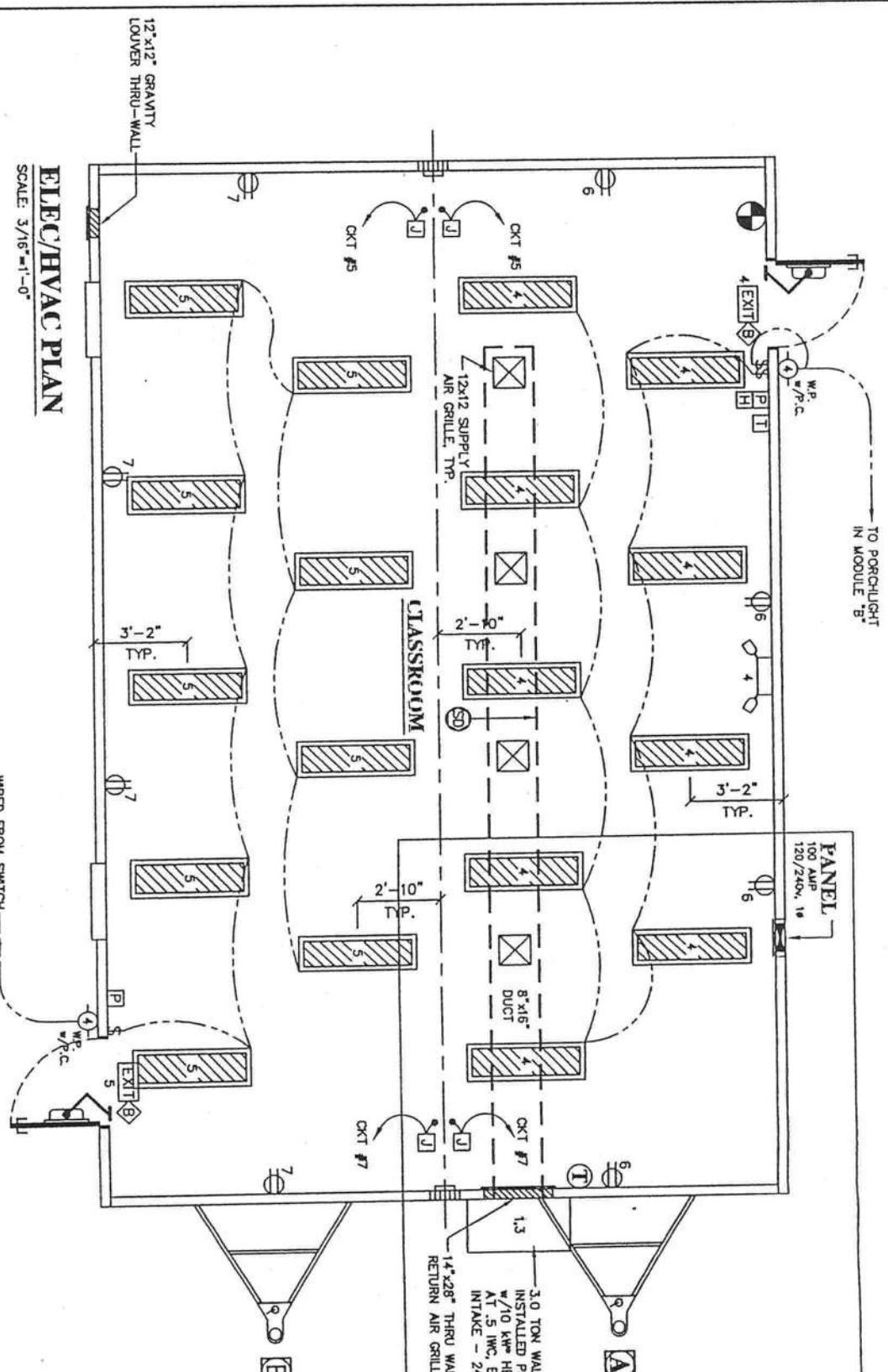

ELECTRICAL SYMBOLS

- ⊕ DUPLEX RECEPTACLE • 16" A.F.F. (UNLESS NOTED)
- ⊕ DUPLEX RECEPTACLE • 42" A.F.F. (UNLESS NOTED)
- ⊕ SWITCH • 48" A.F.F. • 3-WAY SWITCH • 48" A.F.F.
- ⊕ ELECTRICAL PANEL BOX 48" TO BOTTOM
- ⊕ TELEPHONE JACK AT 16" A.F.F. (UNLESS NOTED)
- ⊕ TELEPHONE JACK AT 42" A.F.F. (UNLESS NOTED)
- ⊕ COMPUTER JACK • 16" A.F.F. (UNLESS NOTED)
- ⊕ WEATHERPROOF PHOTOCELL
- ⊕ WALL MOUNTED JUNCTION BOX 16" (UNLESS NOTED)
- ⊕ A/C THERMOSTAT • 53" A.F.F. • FIRE STAT
- ⊕ J-BOX • 48" A.F.F. FOR PULL STATION - TO BE WIRED BACK TO HORN/STROBE (2x4 SINGLE GANG)
- ⊕ J-BOXES • 48" & 80" A.F.F. FOR PULL STATION AND HORN/STROBE (48" BOX: 2x4 SINGLE GANG) (80" BOX: 4x4 DOUBLE GANG)
- ⊕ J-BOX • 80" A.F.F. FOR STROBE ONLY (4x4 DOUBLE GANG)
- ⊕ ILLUMINATED EXIT SIGN
- ⊕ ILLUMINATED EXIT SIGN w/ BATTERY BACK-UP

ELEC/HVAC PLAN

- ⊕ EMERGENCY LIGHT 84" AFF
- ⊕ EXHAUST FAN-100 CFM (UNLESS NOTED)
- ⊕ INCANDESCENT SP. FIXTURE (100W MAX)
- ⊕ WEATHERPROOF LIGHT FIXTURE (100W MAX)
- ⊕ WEATHERPROOF LIGHT PORCH (W. PER SPEC) 7,000 (W. PER SPEC)
- ⊕ HVAC DISCONNECT
- ⊕ DENOTES CROSS CONNECTIONS
- ⊕ FLOUORESCENT LIGHT FIXTURE-RECESSED (2 TUBE-42" MAX.)
- ⊕ TIMER FOR PORCH LIGHTS • 48" A.F.F.

ELECTRICAL NOTES: 1999 NEC

1. ALL ELECTRICAL CONSTRUCTION, MATERIALS AND INSTALLATION MUST BE IN ACCORDANCE WITH NFPA 70, NATIONAL ELECTRICAL CODE AND THE STATE REQUIREMENTS FOR EDUCATIONAL FACILITIES - 1997 AND 1999 SPEC.
2. WHEN LIGHT FIXTURES ARE INSTALLED IN CLOSETS THEY SHALL BE SURFACE MOUNTED OR RECESSED. INCANDESCENT FIXTURES SHALL HAVE COMPLETELY ENCLOSED LAMPS. SURFACE MOUNTED INCANDESCENT FIXTURES SHALL HAVE A MINIMUM CLEARANCE OF 12 INCHES AND ALL OTHER FIXTURES SHALL HAVE A MINIMUM CLEARANCE OF 6 INCHES FROM STORAGE AREA AS DEFINED BY NEC 410-8(d).
3. ALL CIRCUITS CROSSING OVER MODULE MOUNTING LINE(S) SHALL BE SITE CONNECTED IN APPROVED ACCESSIBLE JUNCTION BOXES.
4. THE MAIN ELECTRICAL PANEL AND FEEDERS ARE DESIGNED BY OTHERS. SITE INSTALLED AND SUBJECT TO LOCAL JURISDICTION APPROVAL.
5. IT IS THE RESPONSIBILITY OF THE MANUFACTURER OF THIS BUILDING TO VERIFY THAT THE LIGHTING FIXTURES, WATTAGE ARRANGEMENT, INSTALLATION, ETC., IS IN ACCORDANCE WITH 1997 SPEC. AND 1999 SPEC. CHAPTER 25 (O), ALL CONVENIENCE OUTLETS INSTALLED WITHIN SIX (6) FEET OF WATER SINKS, WET LOCATIONS, TOILET ROOMS AND THE EXTERIOR SHALL HAVE GROUND FAULT CIRCUIT INTERRUPT PROTECTION DEVICE (GFI).
7. EMERGENCY LIGHTING SHALL BE CAPABLE OF PROVIDING ONE FOOTCANDLE MINIMUM ILLUMINATION THROUGHOUT THE MEANS OF EGRESS FOR A PERIOD OF 1-1/2 HOURS IN THE EVENT OF FAILURE OF THE NORMAL LIGHTING. FLUORESCENT TYPE EMERGENCY LIGHTS SHALL NOT BE USED.
8. BALLASTS IN FLUORESCENT FIXTURES SHALL BE ENERGY-SAVING TYPE IN ACCORDANCE WITH FLORIDA STATUTES CHAPTER 55.963 (2) (d).

ELECTRICAL SCHEDULE PANEL

CIRCUIT	DESCRIPTION	BREAKER (AMP-S)	WIRE (CU.)
1,3	HVAC DISCONNECT	15A (2P)	6-2 GND
2	R/RM LIGHT & FAN (IF APPLICABLE)	15A	14-2 NM
4,5	RECEPTS	15A	14-2 NM
6,7	RECEPTS	15A	14-2 NM

ELECTRICAL PANEL "A" SIZING

DESCRIPTION	KVA
0005 kW/SF x 840 SF x 1.25	3.68
8 RECEPTS @ 180 VA / 1000	1.44
WATER HEATER @ 3.5 kW	3.75
2 FANS @ 3.5 kW x 1.25	8.75
1 HVAC @ 5.50 kW (EA)	5.50
TOTAL	23.12
TOTAL / 240 V 1000	47.38
RESTALL 100 AMP PANEL	AMPS

MECHANICAL SCHEDULE PANEL

CIRCUIT	DESCRIPTION	BREAKER (AMP-S)	WIRE (CU.)
1,3	HVAC DISCONNECT	15A (2P)	6-2 GND
2	R/RM LIGHT & FAN (IF APPLICABLE)	15A	14-2 NM
4,5	RECEPTS	15A	14-2 NM
6,7	RECEPTS	15A	14-2 NM

MECHANICAL NOTES: 2001 FMC

1. ALL MECHANICAL CONSTRUCTION, MATERIALS AND INSTALLATION MUST BE IN ACCORDANCE WITH THE 2001 FLORIDA MECHANICAL CODE AND THE STATE REQUIREMENTS FOR EDUCATIONAL FACILITIES - 1997 AND 1999 SPEC.
2. REQUIREMENTS FOR EDUCATIONAL FACILITIES - 1997 AND 1999 SPEC. HVAC EQUIPMENT SHALL BE U.L. LISTED. CONDENSATION PIPE FROM HVAC UNIT TO GRADE SHALL BE SITE INSTALLED. THE SMITH PROGRAMMABLE TIME CLOCK, OR EQUAL SHALL BE INSTALLED ON HVAC FOR ENERGY CONSERVATION. HVAC UNIT SHALL HAVE A MINIMUM SEER RATING OF 9.7 (SINGLE PACKAGE).
3. ALL SUPPLY AIR REGISTERS SHALL BE 10 INCHES x 10 INCHES ADJUSTABLE W/8 INCHES x 16 INCHES OVERHEAD FIBERGLASS DUCT, UNLESS OTHERWISE SPECIFIED. DUCTS LOCATED IN VENTILATED ATTIC SPACES SHALL HAVE AN R-6 INSULATION VALUE. DUCTS LOCATED IN UNCONDITIONED INTERIOR SPACES SHALL HAVE AN R-4.2 INSULATION VALUE. HVAC EQUIPMENT SHALL BE EQUIPPED WITH OUTSIDE FRESH AIR INTAKES PROVIDING 20 CFM FOR EACH OCCUPANT OR 50 CFM FOR EACH WATER CLOSET AND EACH URINAL, WHICHEVER IS GREATER.
4. HVAC UNIT BLOWERS SHALL OPERATE CONTINUOUSLY DURING HOURS OF OCCUPANCY.
5. INSULATED DUCTS FOR CONDITIONED AIR SHALL HAVE A VAPOR BARRIER ON THE WARM SIDE OF THE DUCT.
7. INTERIOR DOORS SHALL BE UNDERCUT 1.5 INCHES ABOVE FINISHED FLOOR.
8. RESTROOM VENT FANS SHALL PROVIDE 50 CFM MINIMUM PER WATER CLOSET AND/OR URINAL.
9. VENT FANS SHALL BE DUCTED TO THE EXTERIOR AND TERMINATE AT AN APPROVED VENT CAP.

OPTIONAL RESTROOM



MECHANICAL NOTES: 2001 FMC

SCALE 3/16"=1'-0"

REVIEWED
 JAN 2 2003
 HILBORN, WERNER, CARTER & ASSOCIATES, INC.
 FOR COMPLIANCE WITH CODES STATED ON PLANS

UBC SPECIFICATIONS:
 HILBORN, WERNER, CARTER & ASSOC., INC.
 1827 SOUTH WENTLE AVENUE
 CLEARWATER, FLORIDA 33766

WJWM
 WILLIAM J. MCCANN, P.E.
 1543 TURNER STREET
 CLEARWATER, FL 33756
 Ph: (727) 443-7660

DATE: 1-15-03
 SCALE: 3/16"=1'-0"
 DRAWN BY: [Signature]
 CHECKED BY: [Signature]
 BRADING NO. # [Blank]
 SERIAL NO. # [Blank]
 VARIES [Blank]
 BALDING SIZE: 24" x 36"
 CODES: [Blank]
 SET NOTES: [Blank]
 LABELS: [Blank]
 SHEET NO. # [Blank]
 PAGE: [Blank]
 JOB NO. # [Blank]
 1715-1023

Custom Craft Mfg.
 P.O. BOX 997
 Zolfo Springs, FL 33880
 (863) 735-0612

ELEC/HVAC PLAN

REV	DATE	BY	DESCRIPTION

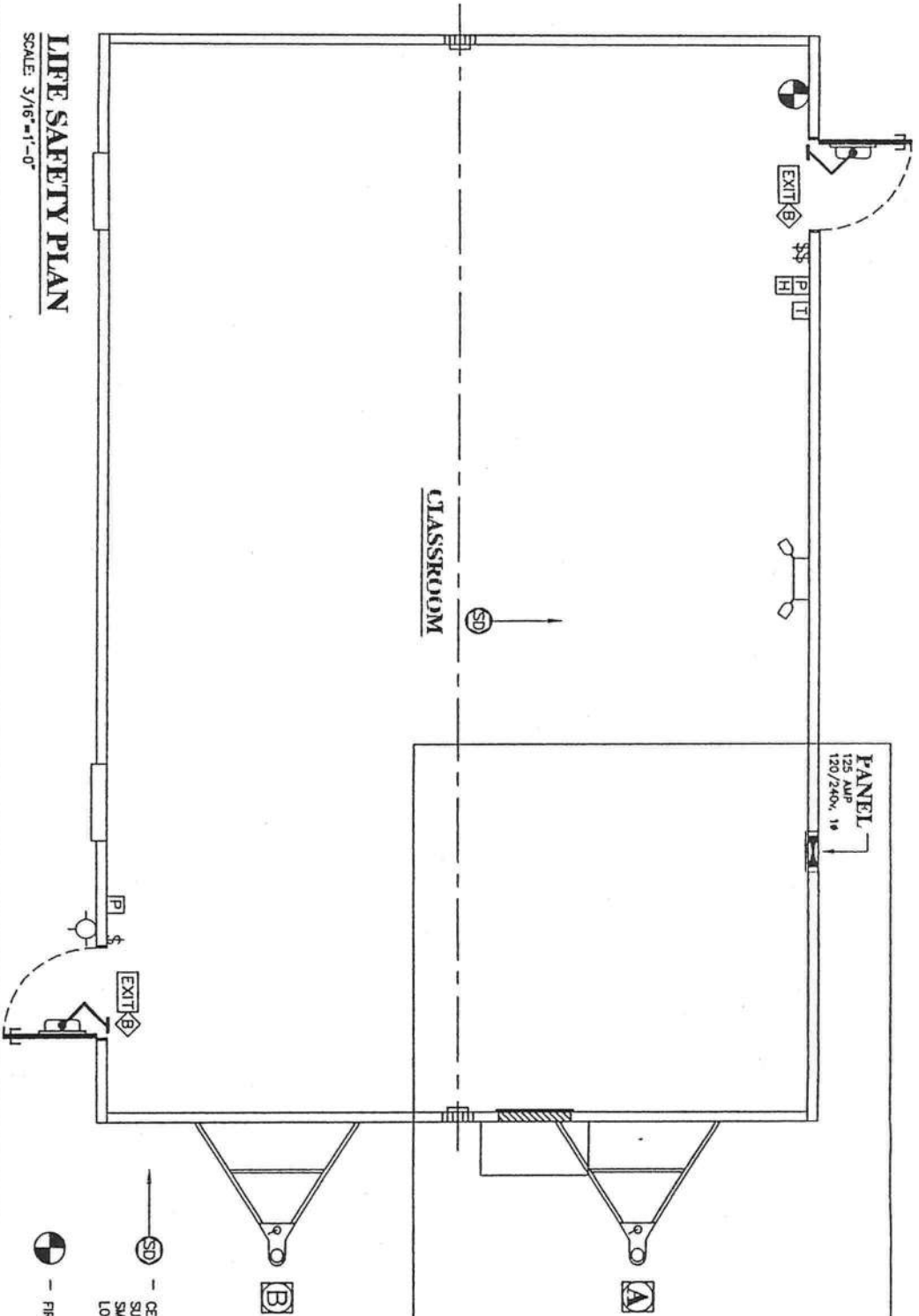

LIFE SAFETY PLAN

SCALE: 3/16"=1'-0"

ACCESSIBILITY NOTES: ADA/ANSI A117.1/FACBC

1. THE INTERNATIONAL SYMBOL OF ACCESSIBILITY SIGN SHALL BE DISPLAYED AT ALL ACCESSIBLE RESTROOM FACILITIES AND AT ACCESSIBLE BUILDING ENTRANCES UNLESS ALL ENTRANCES ARE ACCESSIBLE. INACCESSIBLE ENTRANCES SHALL HAVE DIRECTIONAL SIGNS INDICATING THE ROUTE TO THE NEAREST ACCESSIBLE ENTRANCE.
2. ACCESSIBLE DRINKING FOUNTAINS SHALL HAVE A SPOUT HEIGHT NO HIGHER THAN 36 INCHES ABOVE THE FLOOR AND EDGE OF BASIN NO HIGHER THAN 34 INCHES ABOVE THE FLOOR FOR INDIVIDUALS IN WHEELCHAIRS. ADDITIONALLY, DRINKING WATER PROVISIONS SHALL BE MADE FOR INDIVIDUALS WHO HAVE DIFFICULTY IN BENDING. WHERE STORAGE FACILITIES SUCH AS CABINETS, SHELVES, CLOSETS, AND DRAWERS ARE PROVIDED AT LEAST ONE OF EACH TYPE PROVIDED SHALL CONTAIN STORAGE SPACE COMPLYING WITH THE FOLLOWING: DOORS, ETC. TO SUCH SPACES SHALL BE ACCESSIBLE (i.e. TOUCH LATCHES, U-SHAPED PULLS); SPACES SHALL BE WITHIN 15 INCHES MINIMUM AND 48 INCHES MAXIMUM OF THE FLOOR FOR FORWARD REACH OR 9 INCHES MINIMUM AND 54 INCHES MAXIMUM OF THE FLOOR FOR SIDE REACH; CLOTHES RODS SHALL BE A MAXIMUM OF 54 INCHES ABOVE THE FLOOR (48 INCHES MAXIMUM WHEN DISTANCE FROM WHEELCHAIR TO ROD EXCEEDS 10 INCHES); CONTROLS, DISPENSERS, RECEPTACLES AND OTHER OPERABLE EQUIPMENT SHALL BE NO HIGHER THAN 45 INCHES ABOVE THE FLOOR FOR FRONT APPROACH OR 54 INCHES ABOVE THE FLOOR FOR SIDE APPROACH. RECEPTACLES ON WALLS SHALL BE MOUNTED NO LESS THAN 15 INCHES ABOVE THE FLOOR. EXCEPTION: HEIGHT LIMITATIONS DO NOT APPLY WHERE THE USE OF SPECIAL EQUIPMENT DICTATES OTHERWISE OR WHERE ELECTRICAL RECEPTACLES ARE NOT NORMALLY INTENDED FOR USE BY BUILDING OCCUPANTS.
3. WHERE EMERGENCY WARNING SYSTEMS ARE PROVIDED THEY SHALL INCLUDE BOTH AUDIBLE AND VISUAL ALARMS. THE VISUAL ALARMS SHALL BE LOCATED THROUGHOUT, INCLUDING RESTROOMS, AND PLACED 80 INCHES ABOVE THE FLOOR OR 6 INCHES BELOW CEILING, WHICHEVER IS LOWER.
4. DOORS TO ALL ACCESSIBLE SPACES SHALL HAVE ACCESSIBLE HARDWARE (i.e. LEVER-OPERATED, PUSH-TYPE, U-SHAPED) MOUNTED NO HIGHER THAN 34 INCHES ABOVE THE FLOOR.
5. ALL DOORS SHALL BE OPERABLE BY A SINGLE EFFORT. THE MAXIMUM FORCE REQUIRED TO OPEN A DOOR SHALL NOT EXCEED 8.5 LBS. FOR EXTERIOR SWINGING DOORS AND 5 LBS. FOR ALL SLIDING, FOLDING, AND INTERIOR SWINGING DOORS.

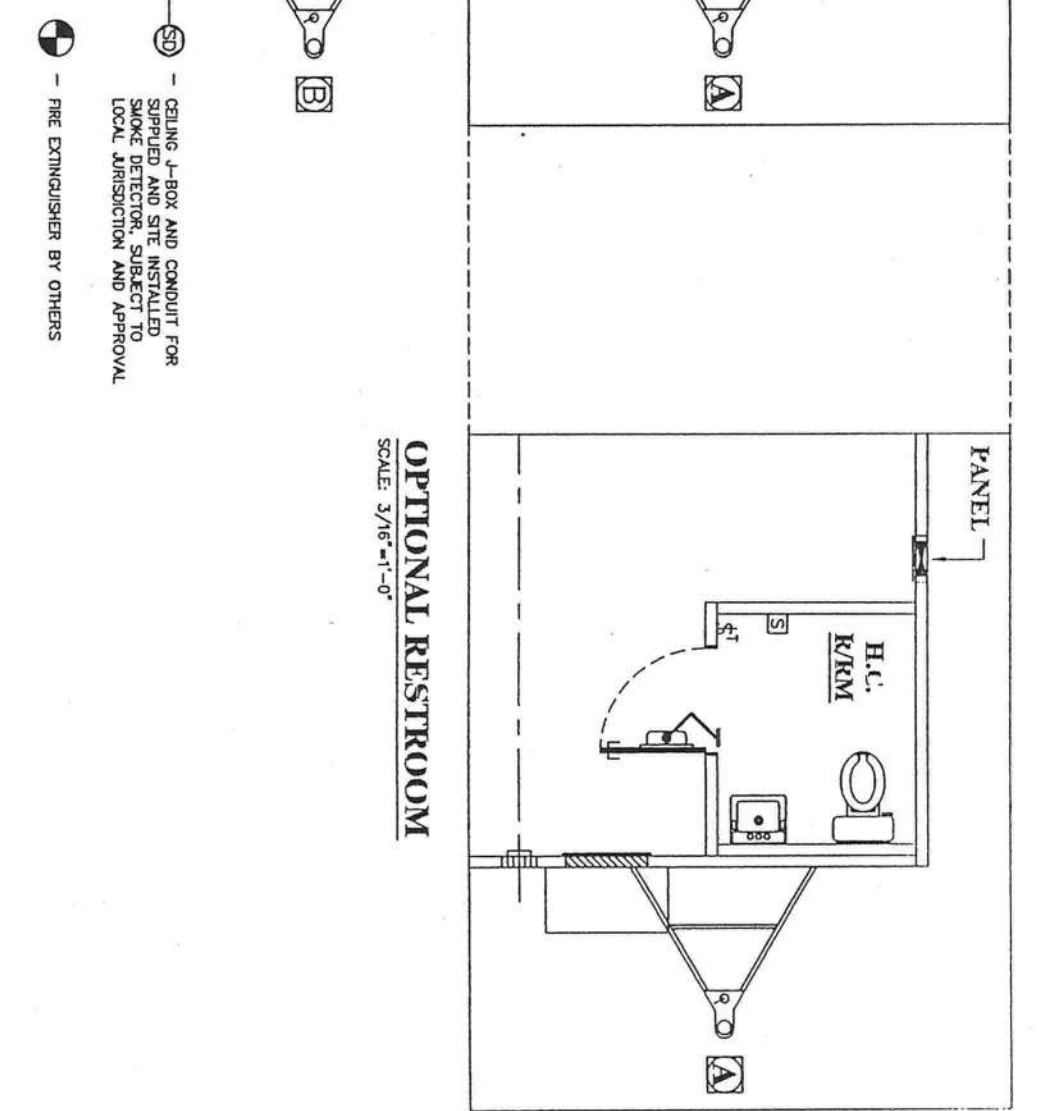

OPTIONAL RESTROOM

SCALE: 3/16"=1'-0"

8. FLOOR SURFACES SHALL BE STABLE, FIRM, AND SLIP-RESISTANT. CHANGES IN LEVEL BETWEEN 0.25 INCH AND 0.5 INCH SHALL BE BEVELED WITH A SLOPE NO GREATER THAN 1:2. CHANGES IN LEVEL GREATER THAN 0.5 INCH REQUIRE RAMPS. CARPET PILE THICKNESS SHALL BE 0.5 INCH MAX. GRABBINGS IN FLOOR SHALL HAVE SPACES NO GREATER THAN 0.5 INCH WIDE IN ONE DIRECTION. DOORWAY THRESHOLDS SHALL NOT EXCEED 0.5 INCH IN HEIGHT. MEASURED TO THE TOP OF THE SEAT. GRAB BARS SHALL BE PROVIDED IN ACCORDANCE WITH DETAILED SKECH IN DRAWINGS.
10. ACCESSIBLE LAVATORIES SHALL BE MOUNTED WITH THE RIM NO HIGHER THAN 22 INCHES A.F.F. FOR PRE-RINSE AND 28 INCHES A.F.F. FOR K-3, AND A CLEARANCE OF AT LEAST 17 INCHES TO THE BOTTOM OF THE APRON. A CLEAR FLOOR SPACE 30 INCH X 48 INCH SHALL BE PROVIDED IN FRONT OF THE LAVATORY.
11. ACCESSIBLE LAVATORIES FOR ALL OTHER USES SHALL BE MOUNTED WITH THE RIM NO HIGHER THAN 34 INCHES A.F.F. WITH A CLEARANCE OF AT LEAST 29 INCHES A.F.F. TO THE BOTTOM OF THE APRON. A CLEAR FLOOR SPACE 30 INCH X 48 INCH SHALL BE PROVIDED IN FRONT OF THE LAVATORY.
12. HOT WATER AND DRAIN PIPES UNDER ACCESSIBLE LAVATORIES AND SINKS SHALL BE INSULATED OR OTHERWISE CONFIGURED TO PROTECT AGAINST CONTACT. INSULATION OR PROTECTIVE MATERIAL MAY BE SITE INSTALLED. THERE SHALL BE NO SHARP OR ABRASIVE SURFACES UNDER ACCESSIBLE LAVATORIES AND SINKS.
13. ACCESSIBLE LAVATORIES AND SINKS SHALL HAVE ACCESSIBLE FAUCETS (i.e. LEVER-OPERATED, PUSH-TYPE, ELECTRONICALLY CONTROLLED).
14. WHERE MIRRORS ARE PROVIDED IN RESTROOM, AT LEAST ONE SHALL BE PROVIDED WITH ITS BOTTOM EDGE NO HIGHER THAN 40 INCHES ABOVE THE FLOOR.
15. WHERE MIRROR CABINETS ARE PROVIDED, AT LEAST ONE SHALL BE LOCATED WITH A USABLE SHELF NO HIGHER THAN 44 INCHES ABOVE THE FLOOR.
16. GRAB BARS REQUIRED FOR ACCESSIBILITY SHALL BE 1.25 INCHES TO 1.5 INCHES IN DIAMETER WITH 1.5 INCHES CLEAR SPACE BETWEEN THE BAR AND THE WALL.
17. TOILET STALL DOORS SHALL BE THE SELF-CLOSING TYPE.
18. A TOWEL DISPENSER SHALL BE LOCATED ADJACENT TO ALL ACCESSIBLE LAVATORIES.
19. WATER CLOSEST FLUSH CONTROL SHALL BE MOUNTED ON THE WIDE SIDE OF THE CLOSET.
20. WHERE DRINKING FOUNTAINS ARE INSTALLED, THERE SHALL BE ONE STANDARD HEIGHT CONVENIENT FOR THOSE WHO HAVE DIFFICULTY BENDING AND ONE WITH A SPOUT HEIGHT NO HIGHER THAN 36 INCHES ABOVE THE FLOOR FOR INDIVIDUALS IN WHEELCHAIRS. FOUNTAINS SHALL HAVE UP FRONT SPOUTS AND EITHER HAND-OPERATED OR HAND-AND-FOOT OPERATED CONTROLS.
21. SERVICE SINK SHALL BE PROVIDED IN AN ADJACENT MAIN BUILDING.

ELECTRICAL SYMBOLS

REVIEWED

FOR COMPLIANCE WITH CODES STATED ON PLANS

JAN 22 2003

HILBORN, WERNER, CARTER & ASSOCIATES, INC.

HWC

UIC INSPECTORS:
WERNER, CARTER & ASSOC., INC.
1827 SOUTH WINTLE AVENUE
CLEARWATER, FLORIDA 33766

LSI	WJM WILLIAM J. McCANN, P.E. 153 TURKEY STREET CLEARWATER, FL 33755 Ph: (727) 443-7680	Custom Craft Mfg. P.O. BOX 897 Zolfo Springs, FL 33890 (863) 735-0812	LIFE/SAFETY PLAN
DATE: 1-15-03	SCALE: 3/16"=1'-0"	REV	DESCRIPTION
DRAWN BY: JLB	CHECKED BY: WJM		
DRAWING NO. #	SERIAL NO. #		
CDL-2003-0004	33755		
VARIES			
BUILDING SIZE: 24' x 36'			
COORS: SEE NOTES			
USERS: JLB			
PAGE: 5 of 6			
JOB NO. #			
1915-1823			

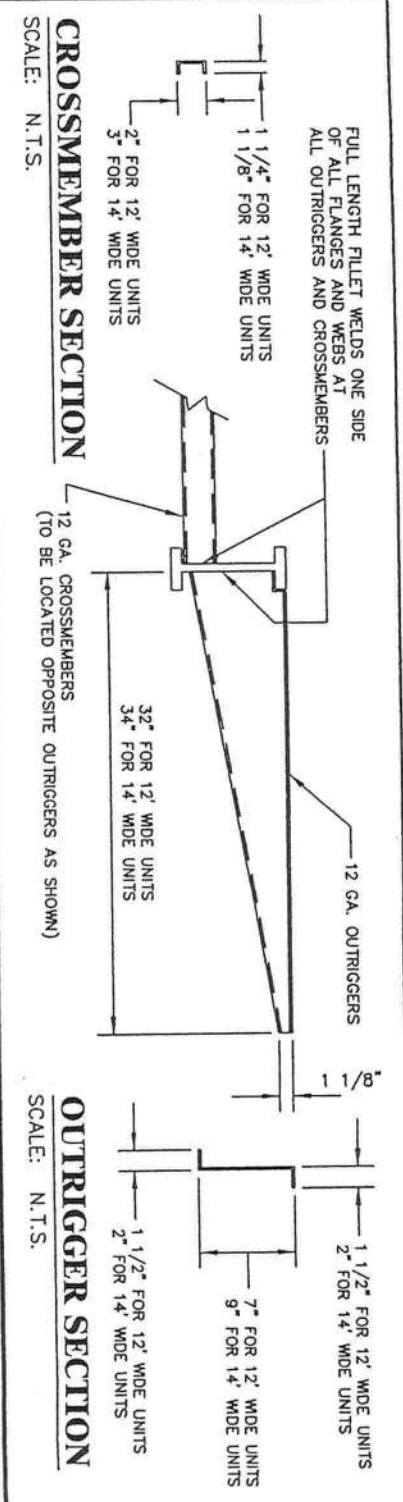

GENERAL CROSS-SECTION NOTES:

- UNLESS OTHERWISE SPECIFIED, ALL STEEL MUST COMPLY W/ ASTM A36. YIELD STRENGTH = 36 KSI.
- ALL LAG SCREWS MUST COMPLY WITH ANSI/ASME B18.2.1. F_y = 60 K.S.I. MIN.

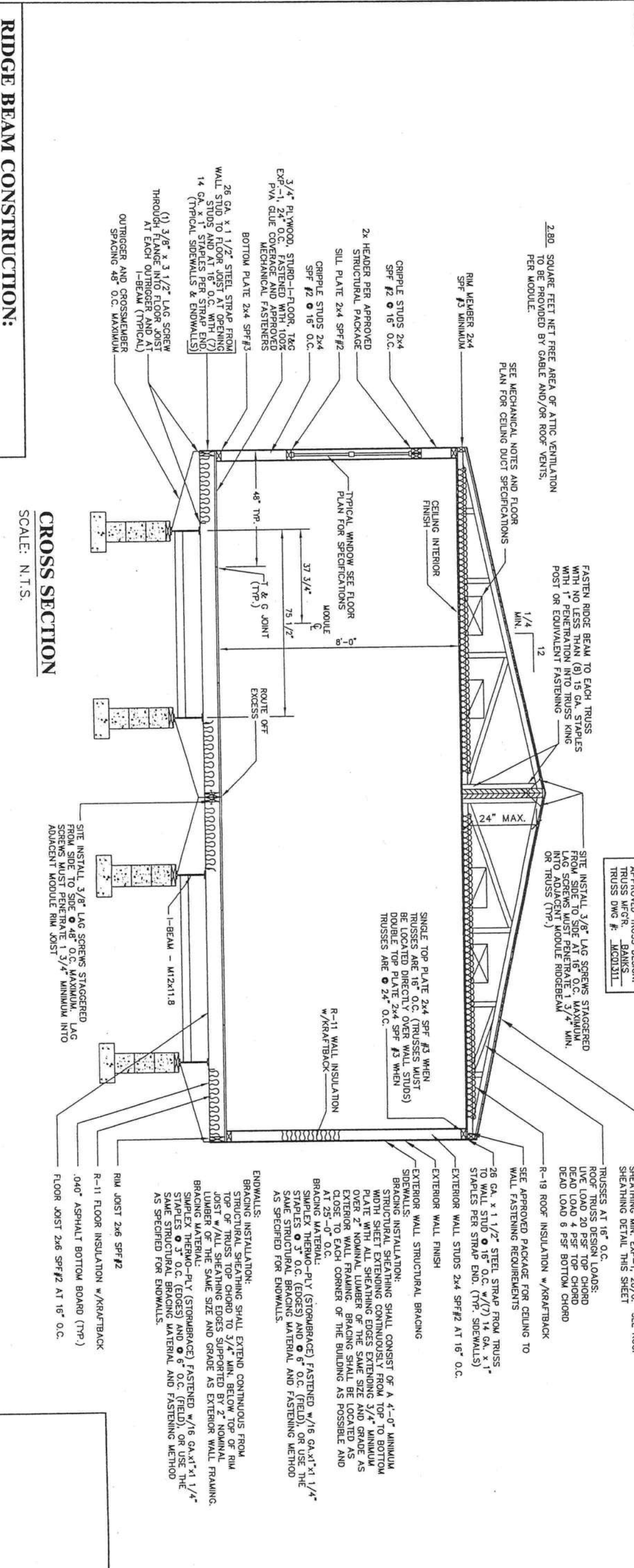
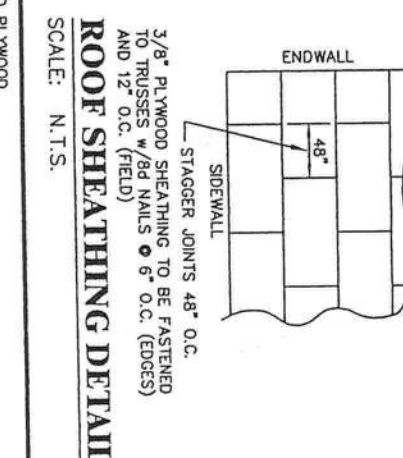

RIDGE BEAM CONSTRUCTION:

- ONE (1) LAYER OF 1 1/2" x 24" MICRO-LAM, EACH MODULE EACH HALF CONTINUOUS ENTIRE LENGTH OF CLEAR SPANS.
- NOTES:**
- MICRO-LAM F = 2,800 PSI.
 - MICRO-LAM MUST BE CONTINUOUS OVER CLEARSPAN(S).
 - BEAMS SUPPORT BY ENDWALL COLUMNS MUST EXTEND CONTINUOUS OVER COLUMNS TO EXTERIOR FACE OF ENDWALL.
 - FASTEN ROOF SHEATHING INTO TOP EDGE OF MICRO-LAM TO PROVIDE CONTINUOUS LATERAL SUPPORT OF BEAM.
 - INSTALL (2x4) x 20" SPF #3 RIDGE BEAM BEARING STIFFENER OVER SUPPORT COLUMNS WHEN SPECIFIED ON FLOOR PLAN. FASTEN THE FACE OF THE STIFFENER TO THE RIDGE BEAM WITH 100% GLUE COVERAGE AND (6) 16 GA. STAPLES WITH 3/4" MINIMUM PENETRATION INTO MICRO-LAM BEAM.
 - WHEN MORE THAN ONE LAYER OF MICRO-LAM IS INSTALLED ON EITHER SIDE OF THE BUILDING MATE LINE, LAYERS ON THAT SIDE OF THE MATE LINE MUST BE FASTENED TOGETHER W/ 16 GA. STAPLES x 7/16" MINIMUM CROWN (INSTALLED PARALLEL TO BEAM SPAN) x 3/4" MINIMUM PENETRATION INTO CONNECTING LAYER. STAPLES SHALL BE PLACED @ 6" O.C. MAXIMUM VERTICALLY AND HORIZONTALLY WITH FIRST AND LAST ROW

CROSS SECTION

INTERIOR FINISH MATERIAL:

- CEILING: 1/2 INCH GYPSUM BOARD INSTALLED PER MANUFACTURER'S SPECIFICATIONS. (PRE-FINISHED) AND WET SPRAY-ON FINISH IS USED. GYPSUM BOARD SHALL BE 5/8 INCH THICK OR GOLD BOND 1/2 INCH HIGH STRENGTH CEILING BOARD OR EQUAL SHALL BE USED.
- WALL: 3/8" VINYL COVERED GYPSUM BOARD - CLASSROOM ONLY. 1/8" F.R.P. BOARD OVER GYPSUM BOARD - RESTROOM ONLY. INSTALLED PER MANUFACTURER'S SPECIFICATIONS.
- FLOOR: VINYL ROLL GOODS - RESTROOM ONLY (SEAL SEAMS AND COVE UP R/RM WALLS 6" TRP.) CARPET - CLASSROOM AREA ONLY.

EXTERIOR FINISH MATERIAL:

- ROOF: 30 GA. GALVANIZED METAL ROOF COVERING INSTALLED PER MANUFACTURER'S SPECIFICATIONS.
- WALL: .019 INCH ALUMINIUM SIDING OVER APPROVED BRACING MATERIAL.

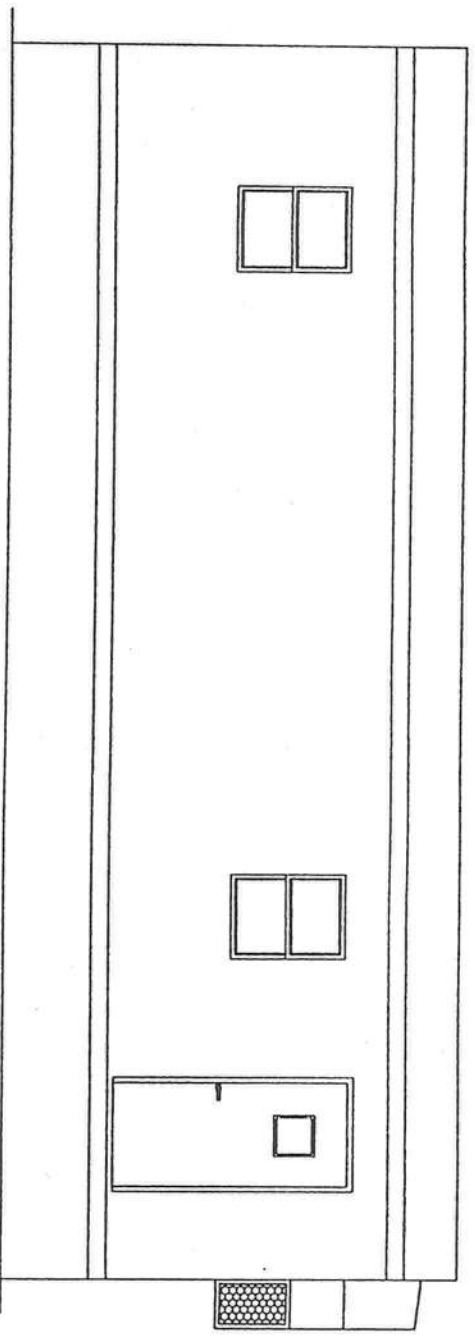

FRONT ELEVATION
SCALE: 3/16"=1'-0"

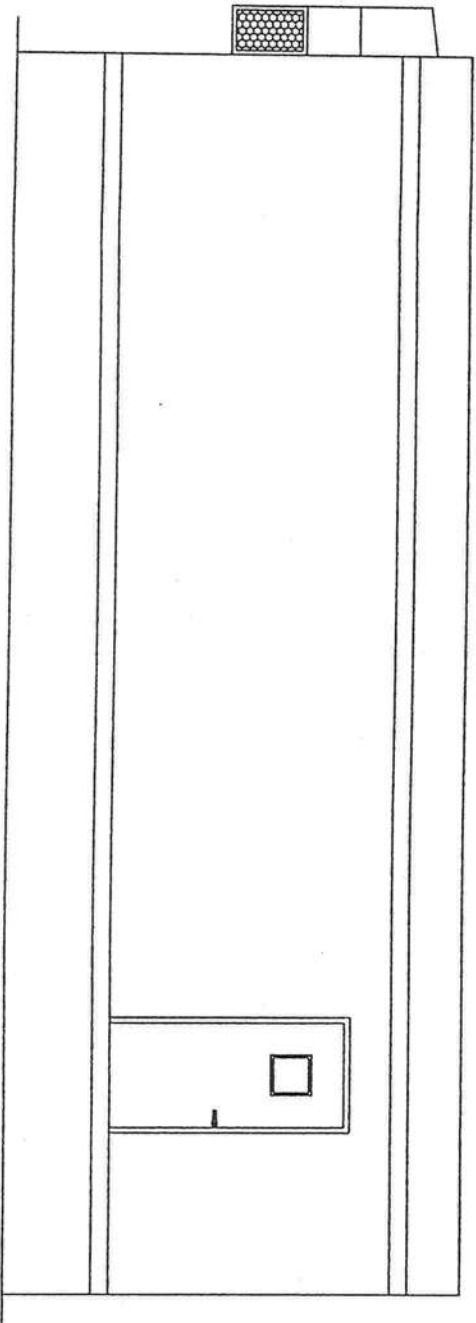

REAR ELEVATION
SCALE: 3/16"=1'-0"

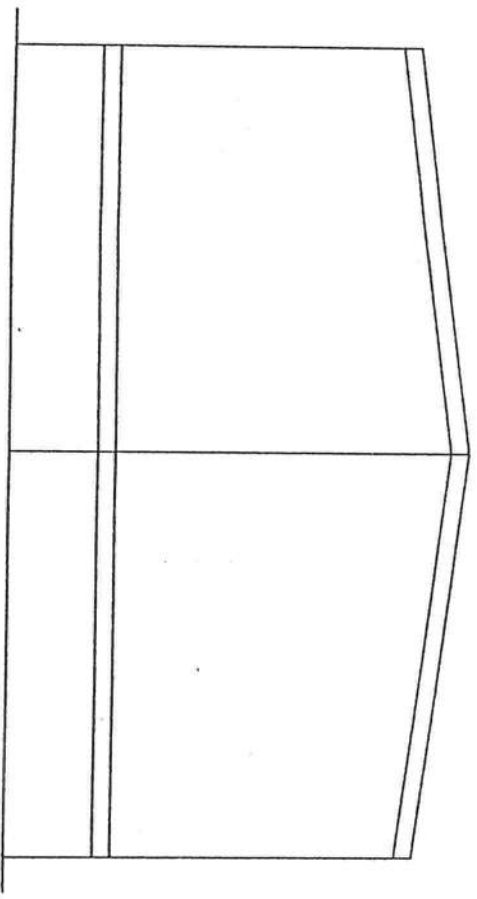

LEFT SIDE ELEVATION
SCALE: 3/16"=1'-0"

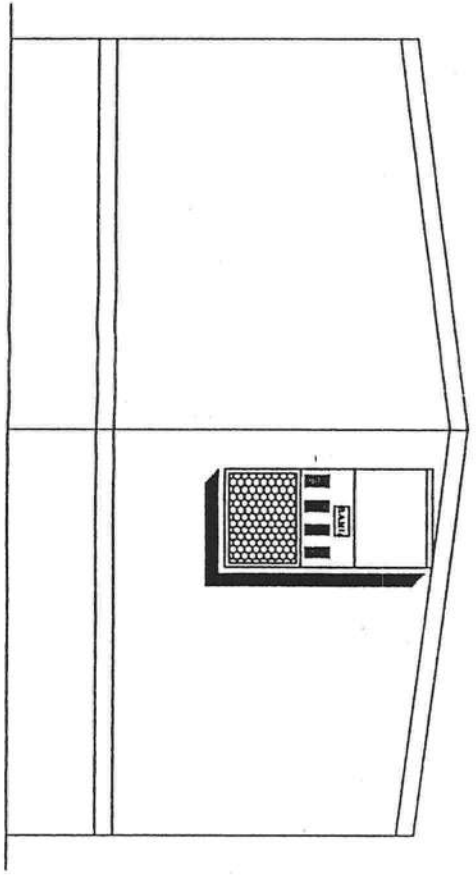

RIGHT SIDE ELEVATION
SCALE: 3/16"=1'-0"

SITE INSTALLED NOTES:

- NOTE THAT THIS LIST DOES NOT NECESSARILY LIMIT THE TERMS OF WORK AND MATERIALS THAT MAY BE REQUIRED FOR A COMPLETE INSTALLATION. ALL SITE RELATED ITEMS ARE SUBJECT TO LOCAL JURISDICTION AND APPROVAL.
1. THE COMPLETE FOUNDATION SUPPORT AND TIE DOWN SYSTEM.
 2. RAMP, STAIR, PLANTINGS AND ROOF COVERINGS AS REQUIRED BY SREF 99.
 3. PORTABLE FIRE EXTINGUISHER(S) AS REQUIRED BY SREF 99.
 4. DRINKING WATER APPARATUS (WHEN NOT SHOWN ON PLAN), BUILDING DRAINS, CLEANOUTS AND CONNECTION TO THE PLUMBING SYSTEMS.
 5. ELECTRICAL SERVICE HOOK-UP (INCLUDING FEEDERS) TO THE BUILDING.
 6. THE MAIN ELECTRICAL PANEL AND SUB-FEEDERS (MULTI-UNITS ONLY).
 7. CONNECTION OF ELECTRICAL CIRCUITS CROSSING OVER MODULE MATING LINES(S) - (MULTI-UNITS ONLY).
 8. STRUCTURAL AND AESTHETIC INTERCONNECTIONS BETWEEN MODULES (MULTI-UNITS ONLY).
 9. WINDOW AND DOOR HIGH WIND STORM COVERINGS PER CODE.
 10. REQUIRED PLUMBING FACILITIES NOT PROVIDED IN THE MODULAR BUILDINGS WHICH ARE TO BE LOCATED IN ADJACENT BUILDINGS.
 11. DRAINAGE PIPING AND SIGNALING SYSTEM PER NFPA-72 SHALL BE DESIGNED, SUPPLIED AND SITE INSTALLED BY OTHERS, SUBJECT TO LOCAL JURISDICTION AND APPROVAL. J-BOXES AND CONDUIT RACEWAYS HAVE BEEN PROVIDED IN THE MODULAR DESIGN FOR THIS PURPOSE.
 12. SPRINKLER SYSTEM (IF APPLICABLE).
 13. INVENTORY/CONSTRUCTION DATE SIGNAGE AS DEFINED IN SREF-99 NOT IDENTIFIED IN PLANS.
 14. GUTTERS & DOWNSPOUTS
 - 15.

FOUNDATION:

THESE BUILDING PLANS DO NOT CONTAIN FOUNDATION SUPPORT AND TIE DOWN SYSTEM DETAILS AND SPECIFICATIONS. THE ARCHITECT / ENGINEER OF BUILDING PLANS SHOULD BE CONTACTED TO OBTAIN APPROPRIATE FOUNDATION PLANS. IF FOUNDATION PLANS ARE DESIGNED BY OTHERS, THE ARCHITECT / ENGINEER OF BUILDING PLANS SHALL NOT BE HELD RESPONSIBLE OR LIABLE FOR THE FOUNDATION DESIGN AND THE CONSEQUENTIAL PERFORMANCE OF THE SUPERSTRUCTURE'S STRUCTURAL COMPONENTS AND SYSTEMS RELATING THERETO.

ELEVATION NOTES (TYP.)

- 1.) SEE CROSS SECTION FOR METHOD OF ROOF VENTILATION
- 2.) HANDICAP RAMPS(S), STAIRS(S), AND HANDRAILS ARE TO BE DESIGNED AND SITE INSTALLED BY OTHERS, SUBJECT TO LOCAL JURISDICTION AND APPROVAL
- 3.) FOUNDATION ENCLOSURE (WHEN PROVIDED) MUST HAVE 1 SQUARE FOOT NET VENT AREA PER 1/50TH OF THE FLOOR AREA, AND AN 18" x 24" MINIMUM CRAWL SPACE ACCESS, SITE INSTALLED BY OTHERS, SUBJECT TO LOCAL JURISDICTION AND APPROVAL.

REV	DATE	BY	DESCRIPTION

Custom Craft Mfg.
P.O. BOX 997
Zolfo Springs, FL 33890
(863) 735-0812

EXTERIOR ELEVATIONS

DATE: 1-15-03
SCALE: 3/16"=1'-0"
DRAWN BY: WJW
CHECKED BY: WJW
DRAWING NO. & COL: 2003-0004
SHEET NO. & TOTAL: 2 OF 8
JOB NO. & DATE: 1815-1823

WJW
WILLIAM J. McCANN, P.E.
1563 TURNER STREET
CLEARWATER, FL 33766
Ph: (727) 443-7860

REVIEWED
JAN 21 2003
HILBORN, WERNER, CARTER & ASSOCIATES, INC.
HWC

FOR COMPLIANCE WITH CODES STATED ON PLANS

USG INSPECTIONS:
HILBORN, WERNER, CARTER & ASSOC., INC.
1500 W. WINDY HILL AVENUE
CLEARWATER, FLORIDA 33758

WJW
P.L.E. Lic. #50252

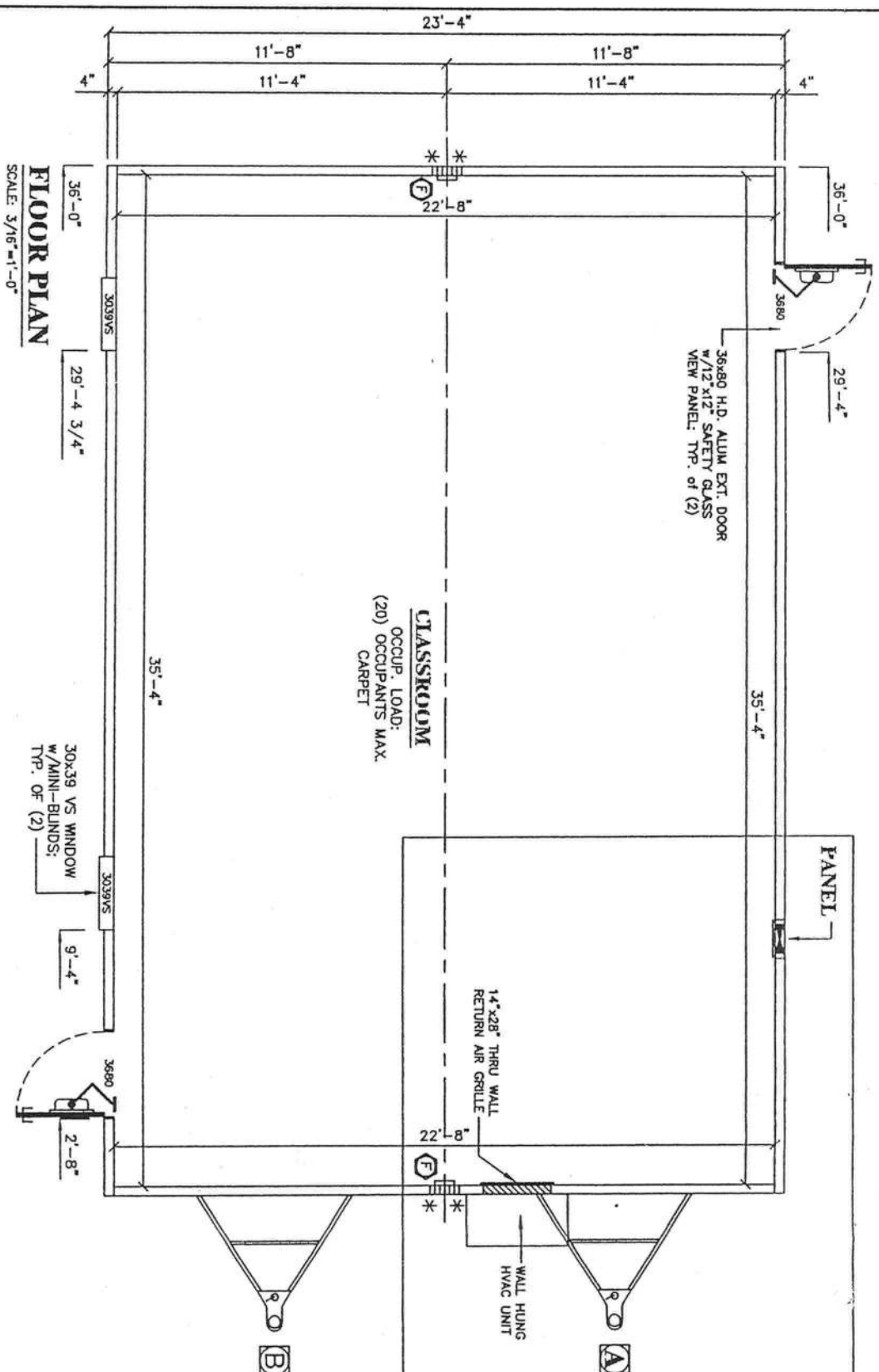

FLOOR PLAN
SCALE: 3/16"=1'-0"

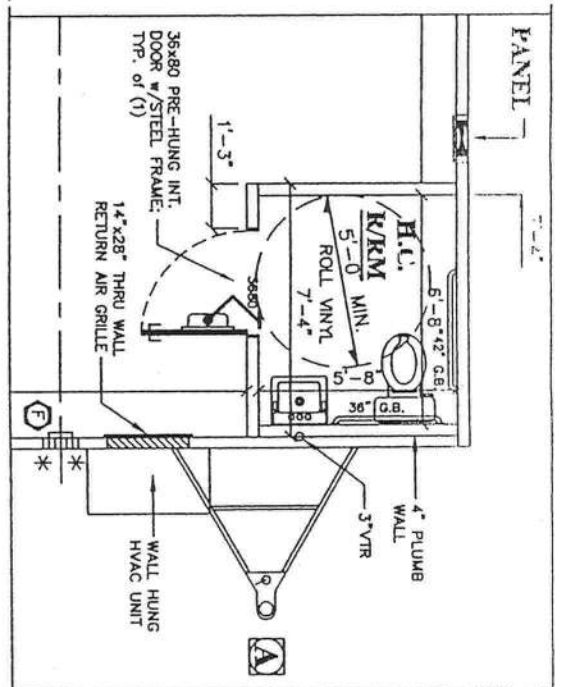

OPTIONAL RESTROOM
SCALE: 3/16"=1'-0"

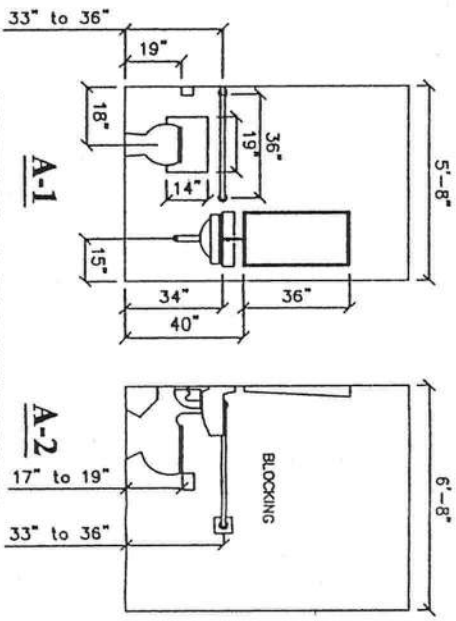

INTERIOR ELEVATIONS
SCALE: 3/16"=1'-0"

COLUMN STRAPPING SCHEDULE

- (A) (2) 2x4 SPF #2 THIS HALF
- (B) (2) 2x4 SPF #2 EACH HALF
- (C) (3) 2x4 SPF #2 THIS HALF
- (D) (3) 2x4 SPF #2 EACH HALF
- (E) (4) 2x4 SPF #2 THIS HALF
- (F) (4) 2x4 SPF #2 EACH HALF
- (G) (5) 2x4 SPF #2 THIS HALF
- (H) (5) 2x4 SPF #2 EACH HALF

* ADD RIDGE BEAM BEARING STIFFENER
● STRUCTURAL HEADER ABOVE OPENING

NOTES:
1. ALL COLUMN STUDS SHALL BE GLUE/NAILED TOGETHER.
2. INSTALL TWO STEEL STRAPS AT EACH STUD OF EACH COLUMN.
3. COLUMN STUDS SHALL NOT BE NOTCHED OR BORED.

SUPPLY RISER
SCALE: N.T.S.

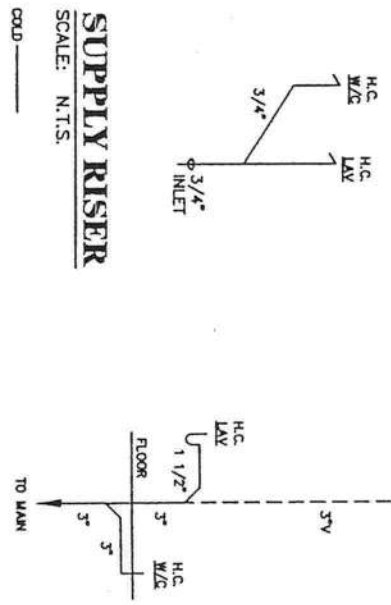

ALL SUPPLY LINES SHALL BE 3/4" AND ALL STUB-UPS SHALL BE 1/2" UNLESS OTHERWISE SPECIFIED. SUPPLY LINE SIZING IS BASED ON AN ASSUMED AVAILABLE PRESSURE OF 45 TO 60 PSI AT MAIN INLET AND SHOULD BE VERIFIED PRIOR TO CONSTRUCTION.

D.W.V. RISER
SCALE: N.T.S.

PLUMBING NOTES: 2001 FPC

1. WHEN DRINKING WATER FACILITIES ARE NOT SHOWN ON FLOOR PLAN, THE BUILDING MANUFACTURER SHALL SHIP LOOSE A BOTTLED WATER DISPENSER WITH BUILDING FOR FIELD INSTALLATION BY OTHERS.
2. TOILETS SHALL BE ELONGATED WITH NON-ABSORBENT OPEN FRONT SEATS.
3. RESTROOM WALLS SHALL BE COVERED WITH NON-ABSORBENT MATERIAL TO A MINIMUM HEIGHT OF 72 INCHES A.F.F.
4. ALL PLUMBING FIXTURES SHALL HAVE SEPARATE SHUT-OFF VALVES.
5. WATER HEATER SHALL HAVE SAFETY PAN WITH 1 INCH DRAIN TO EXTERIOR. T & P RELIEF VALVE WITH DRAIN TO EXTERIOR, AND A SHUT OFF VALVE WITHIN 3 FEET ON A COLD WATER SUPPLY LINE.
6. DWV SYSTEM SHALL BE EITHER ABS OR PVC - DWV.
7. WATER SUPPLY LINES SHALL BE POLYBUTYLENE, CPVC, OR COPPER; WHEN POLYBUTYLENE SUPPLY LINES ARE INSTALLED THE MAXIMUM WATER HEATER TEMPERATURE SETTING IS 180° F. THE POLYBUTYLENE PIPE SHALL BE INSTALLED IN ACCORDANCE WITH THE MANUFACTURERS LIMITATIONS AND INSTRUCTIONS.
8. WATER CLOSETS ARE TANK TYPE AND URINALS ARE FLUSH TANK TYPE UNLESS OTHERWISE SPECIFIED.
9. BUILDING DRAIN AND CLEANOUTS ARE DESIGNED AND SITE INSTALLED BY OTHERS.
10. SUBJECT TO LOCAL JURISDICTION APPROVAL SHOWERS SHALL BE CONTROLLED BY AN APPROVED MIXING VALVE WITH A MAXIMUM WATER OUTLET TEMPERATURE OF 120° F (48.8° C).
11. THERMAL EXPANSION DEVICE, IF REQUIRED BY WATER HEATER INSTALLED, AND IF NOT SHOWN ON PLUMBING PLAN, IS DESIGNED AND SITE INSTALLED BY OTHERS.
12. SERVICE SINK SHALL BE PROVIDED IN AN ADJACENT MAIN BUILDING.

REVIEWED
FOR COMPLIANCE WITH CODES STATED ON PLANS
JAN 2 2003
HWC
HILBORN, WERNER, CARTER & ASSOCIATES, INC.

DATE: 1-15-03
SCALE: 3/16"=1'-0"
DRAWN BY: J.L.B.
CHECKED BY: W.J.M.
DRAWING NO. & COL: 2003-0004
SERIAL NO. & VARIES
BUILDING SIZE: 24' x 36'

Custom Craft Mfg.
P.O. BOX 997
Zolfo Springs, FL 33890
(863) 735-0612

LIFE/SAFETY PLAN

REV	DATE	BY	DESCRIPTION

UBC INSPECTIONS: HILBORN, WERNER, CARTER & ASSOC., INC. 1827 SOUTH MARLIE AVENUE CLEARWATER, FLORIDA 33756

WJ.M.
WILLIAM J. McCANN, P.E.
1563 TURNER STREET
CLEARWATER, FL 33756
Ph: (727) 443-7660

FL P.E. LIC. #50252

LSI