

This document has been electronically signed and sealed using a Digital Signature. Printed copies without an original signature must be verified using the original electronic version.

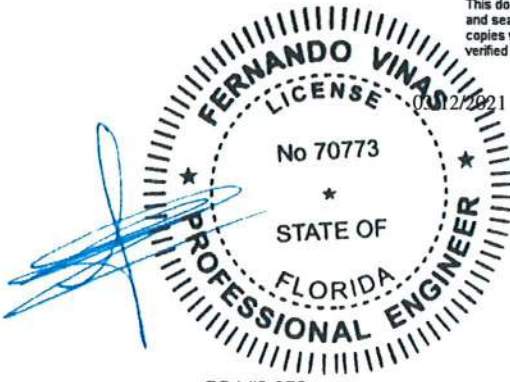

Alpine, an ITW Company  
6750 Forum Drive, Suite 305  
Orlando, FL 32821  
Phone: (800)755-6001  
www.alpineitw.com



COA#0-278

<b>Site Information:</b>	<b>Page 1:</b>
<i>Customer:</i> Seminole Trusses, Inc.	<i>Job Number:</i> B53089a
<i>Job Description:</i> DANIELLO RESIDENCE	
<i>Address:</i> 1028 SW HIGH FIELD TERRACE, LAKE CITY, FL 32024	

<b>Job Engineering Criteria:</b>	
<i>Design Code:</i> FBC 7th Ed. 2020 Res	<i>IntelliVIEW Version:</i> 20.02.00A
	<i>JRef #:</i> 1X3N8570007
<i>Wind Standard:</i> ASCE 7-16 <i>Wind Speed (mph):</i> 130	<i>Design Loading (psf):</i> 37.00
<i>Building Type:</i> Closed	

This package contains general notes pages, 5 truss drawing(s) and 5 detail(s).

Item	Drawing Number	Truss
1	071.21.1556.46297	A1-SG 34' Gable
3	071.21.1556.51103	B1-G 29' Gable
5	071.21.1556.57960	V1-G 20' Valley
7	GBLLETIN0118	
9	PB180160118	

Item	Drawing Number	Truss
2	071.21.1556.48187	A2 34' Common
4	071.21.1556.53043	B2 29' Common
6	A14015ENC160118	
8	PB160160118	
10	REPCHRD1014	

## **General Notes**

### **Truss Design Engineer Scope of Work, Design Assumptions and Design Responsibilities:**

The design responsibilities assumed in the preparation of these design drawings are those specified in ANSI/TPI 1, Chapter 2; and the National Design Standard for Metal Plate Connected Wood Truss Construction, by the Truss Plate Institute. The truss component designs conform to the applicable provisions of ANSI/TPI 1 and NDS, the National Design Specification for Wood Construction by AWC. The truss component designs are based on the specified loading and dimension information furnished by others to the Truss Design Engineer. The Truss Design Engineer has no duty to independently verify the accuracy or completeness of the information provided by others and may rely on that information without liability. The responsibility for verification of that information remains with others neither employed nor controlled by the Truss Design Engineer. The Truss Design Engineer's seal and signature on the attached drawings, or cover page listing these drawings, indicates acceptance of professional engineering responsibility solely for the truss component designs and not for the technical information furnished by others which technical information and consequences thereof remain their sole responsibility.

The suitability and use of these drawings for any particular structure is the responsibility of the Building Designer in accordance with ANSI/TPI 1 Chapter 2. The Building Designer is responsible for determining that the dimensions and loads for each truss component match those required by the plans and by the actual use of the individual component, and for ascertaining that the loads shown on the drawings meet or exceed applicable building code requirements and any additional factors required in the particular application. Truss components using metal connector plates with integral teeth shall not be placed in environments that will cause the moisture content of the wood in which plates are embedded to exceed 19% and/or cause corrosion of connector plates and other metal fasteners.

The Truss Design Engineer shall not be responsible for items beyond the specific scope of the agreed contracted work set forth herein, including but not limited to: verifying the dimensions of the truss component, calculation of any of the truss component design loads, inspection of the truss components before or after installation, the design of temporary or permanent bracing and their attachment required in the roof and/or floor systems, the design of diaphragms or shear walls, the design of load transfer connections to and from diaphragms and shear walls, the design of load transfer to the foundation, the design of connections for truss components to their bearing supports, the design of the bearing supports, installation of the truss components, observation of the truss component installation process, review of truss assembly procedures, sequencing of the truss component installation, construction means and methods, site and/or worker safety in the installation of the truss components and/or its connections.

This document may be a high quality facsimile of the original engineering document which is a digitally signed electronic file with third party authentication. A wet or embossed seal copy of this engineering document is available upon request.

### **Temporary Lateral Restraint and Bracing:**

Temporary lateral restraint and diagonal bracing shall be installed according to the provisions of BCSI chapters B1, B2, B7 and/or B10 (Building Component Safety Information, by TPI and SBCA), or as specified by the Building Designer or other Registered Design Professional. The required locations for lateral restraint and/or bracing depicted on these drawings are only for the permanent lateral support of the truss members to reduce buckling lengths, and do not apply to and may not be relied upon for the temporary stability of the truss components during their installation.

### **Permanent Lateral Restraint and Bracing:**

The required locations for lateral restraint or bracing depicted on these drawings are for the permanent lateral support of the truss members to reduce buckling lengths. Permanent lateral support shall be installed according to the provisions of BCSI chapters B3, B7 and/or B10, or as specified by the Building Designer or other Registered Design Professional. These drawings do not depict or specify installation/erection bracing, wind bracing, portal bracing or similar building stability bracing which are parts of the overall building design to be specified, designed and detailed by the Building Designer.

### **Connector Plate Information:**

Alpine connector plates are made of ASTM A653 or ASTM A1063 galvanized steel with the following designations, gauges and grades: W=Wave, 20ga, grade 40; H=High Strength, 20ga, grade 60; S=Super Strength, 18ga, grade 60. Information on model code compliance is contained in the ICC Evaluation Service report ESR-1118, available on-line at [www.icc-es.org](http://www.icc-es.org).

### **Fire Retardant Treated Lumber:**

Fire retardant treated lumber must be properly re-dried and maintained below 19% or less moisture level through all stages of construction and usage. Fire retardant treated lumber may be more brittle than untreated lumber. Special handling care must be taken to prevent breakage during all handling activities.

## **General Notes** (continued)

### **Key to Terms:**

Information provided on drawings reflects a summary of the pertinent information required for the truss design. Detailed information on load cases, reactions, member lengths, forces and members requiring permanent lateral support may be found in calculation sheets available upon written request.

BCDL = Bottom Chord standard design Dead Load in pounds per square foot.

BCLL = Bottom Chord standard design Live Load in pounds per square foot.

CL = Certified lumber.

Des Ld = total of TCLL, TCDL, BCLL and BCDL Design Load in pounds per square foot.

FRT = Fire Retardant Treated lumber.

FRT-DB = D-Blaze Fire Retardant Treated lumber.

FRT-DC = Dricon Fire Retardant Treated lumber.

FRT-FP = FirePRO Fire Retardant Treated lumber.

FRT-FL = FlamePRO Fire Retardant Treated lumber.

FRT-FT = FlameTech Fire Retardant Treated lumber.

FRT-PG = PYRO-GUARD Fire Retardant Treated lumber.

g = green lumber.

HORZ(LL) = maximum Horizontal panel point deflection due to Live Load, in inches.

HORZ(TL) = maximum Horizontal panel point long term deflection in inches, due to Total Load, including creep adjustment.

HPL = additional Horizontal Load added to a truss Piece in pounds per linear foot or pounds.

Ic = Incised lumber.

FJ = Finger Jointed lumber.

L/# = user specified divisor for limiting span/deflection ratio for evaluation of actual L/defl value.

L/defl = ratio of Length between bearings, in inches, divided by the vertical Deflection due to creep, in inches, at the referenced panel point. Reported as 999 if greater than or equal to 999.

Loc = Location, starting location of left end of bearing or panel point (joint) location of deflection.

Max BC CSI = Maximum bending and axial Combined Stress Index for Bottom Chords for of all load cases.

Max TC CSI = Maximum bending and axial Combined Stress Index for Top Chords for of all load cases.

Max Web CSI = Maximum bending and axial Combined Stress Index for Webs for of all load cases.

NCBCLL = Non-Concurrent Bottom Chord design Live Load in pounds per square foot.

PL = additional Load applied at a user specified angle on a truss Piece in pounds per linear foot or pounds.

PLB = additional vertical load added to a Bottom chord Piece of a truss in pounds per linear foot or pounds

PLT = additional vertical load added to a Top chord Piece of a truss in pounds per linear foot or pounds.

PP = Panel Point.

R = maximum downward design Reaction, in pounds, from all specified gravity load cases, at the indicated location (Loc).

-R = maximum upward design Reaction, in pounds, from all specified gravity load cases, at the identified location (Loc).

Rh = maximum horizontal design Reaction in either direction, in pounds, from all specified gravity load cases, at the indicated location (Loc).

RL = maximum horizontal design Reaction in either direction, in pounds, from all specified non-gravity (wind or seismic) load cases, at the indicated location (Loc).

Rw = maximum downward design Reaction, in pounds, from all specified non-gravity (wind or seismic) load cases, at the identified location (Loc).

TCDL = Top Chord standard design Dead Load in pounds per square foot.

TCLL = Top Chord standard design Live Load in pounds per square foot.

U = maximum Upward design reaction, in pounds, from all specified non-gravity (wind or seismic) load cases, at the indicated location (Loc).

VERT(CL) = maximum Vertical panel point deflection in inches due to Live Load and Creep Component of Dead Load in inches.

VERT(CTL) = maximum Vertical panel point deflection ratios due to Live Load and Creep Component of Dead Load, and maximum long term Vertical panel point deflection in inches due to Total load, including creep adjustment.

VERT(LL) = maximum Vertical panel point deflection in inches due to Live Load.

VERT(TL) = maximum Vertical panel point long term deflection in inches due to Total load, including creep adjustment.

W = Width of non-hanger bearing, in inches.

Refer to ASCE-7 for Wind and Seismic abbreviations.

Uppercase Acronyms not explained above are as defined in TPI 1.

**References:**

1. AWC: American Wood Council; 222 Catoclin Circle SE, Suite 201; Leesburg, VA 20175; [www.awc.org](http://www.awc.org).
2. ICC: International Code Council; [www.iccsafe.org](http://www.iccsafe.org).
3. Alpine, a division of ITW Building Components Group Inc.: 514 Earth City Expressway, Suite 242, Earth City, MO 63045; [www.alpineitw.com](http://www.alpineitw.com).
4. TPI: Truss Plate Institute, 2670 Crain Highway, Suite 203, Waldorf, MD 20601; [www.tpinst.org](http://www.tpinst.org).
5. SBCA: Wood Truss Council of America, 6300 Enterprise Lane, Madison, WI 53719; [www.sbcindustry.com](http://www.sbcindustry.com).

SEQN: 32983 FROM: RJL	GABL Ply: 1 Qty: 2	Job Number: B53089a DANIELLO RESIDENCE Truss Label: A1-SG 34' Gable	Cust: R 857 JRef: 1X3N8570007 T4 DrvNo: 071.21.1556.46297 JB / FV 03/12/2021
--------------------------	--------------------------	---	--

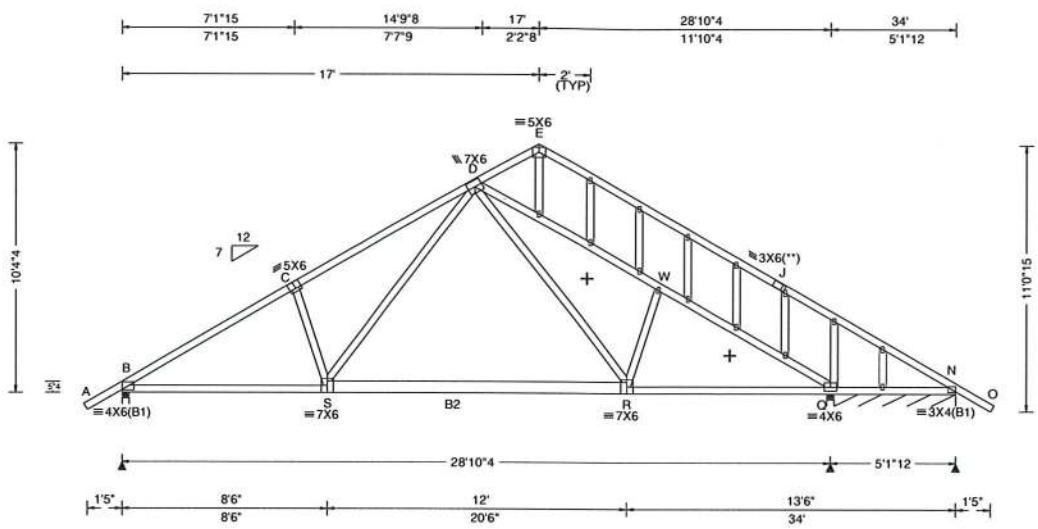

<b>Loading Criteria (psf)</b> TCLL: 20.00 TCDL: 7.00 BCLL: 0.00 BCDL: 10.00 Des Ld: 37.00 NCBCLL: 10.00 Soffit: 0.00 Load Duration: 1.25 Spacing: 24.0"	<b>Wind Criteria</b> Wind Std: ASCE 7-16 Speed: 130 mph Enclosure: Closed Risk Category: II EXP: B Kzt: NA Mean Height: 15.00 ft TCDL: 4.2 psf BCDL: 5.2 psf MWFRS Parallel Dist: 0 to h/2 C&C Dist a: 3.40 ft Loc. from endwall: Any GCpi: 0.18 Wind Duration: 1.60	<b>Snow Criteria (Pg,Pf in PSF)</b> Pg: NA Ct: NA CAT: NA Pf: NA Ce: NA Lu: NA Cs: NA Snow Duration: NA  Building Code: FBC 7th Ed. 2020 Res. TPI Std: 2014 Rep Fac: No FT/RT:20(0)/10(0) Plate Type(s): WAVE	<b>Def/CSI Criteria</b> PP Deflection in loc L/defl L/# VERT(LL): 0.086 S 999 360 VERT(CL): 0.184 F 999 240 HORZ(LL): 0.035 L - - HORZ(TL): 0.076 L - - Creep Factor: 2.0 Max TC CSI: 0.849 Max BC CSI: 0.757 Max Web CSI: 0.316  VIEW Ver: 20.02.00A.1020.20	<b>▲ Maximum Reactions (lbs), or *PLF</b> Gravity Loc R+ / R- / Rh / Rw / U / RL Non-Gravity Loc R+ / R- / Rh / Rw / U / RL B 1596 /- /- /701 /80 /234 Q 1582 /- /- /695 /186 /- N* 98 /- /- /39 /- /- Wind reactions based on MWFRS B Brg Width = 3.5 Min Req = 1.9 Q Brg Width = 3.5 Min Req = 1.5 N Brg Width = 60.0 Min Req = - Bearings B, Q, & Q are a rigid surface. Members not listed have forces less than 375# <b>Maximum Top Chord Forces Per Ply (lbs)</b> Chords Tens.Comp. Chords Tens. Comp.
--	---	---	--	---

**Lumber**  
Top chord: 2x4 SP #1;  
Bot chord: 2x4 SP #1; B2 2x6 SP #1;  
Webs: 2x4 SP #3;

**Plating Notes**  
All plates are 1.5X3 except as noted.  
(\*\*) 1 plate(s) require special positioning. Refer to scaled plate plot details for special positioning requirements.

**Loading**  
Truss designed to support 1-0-0 top chord outlookers and cladding load not to exceed 5.00 PSF one face and 24.0" span opposite face. Top chord must not be cut or notched, unless specified otherwise.  
Truss passed check for 20 psf additional bottom chord live load in areas with 42"-high x 24"-wide clearance.

**Wind**  
Wind loads based on MWFRS with additional C&C member design.  
Wind loading based on both gable and hip roof types.

**Blocking**  
Blocking reinforcement required to prevent buckling of members over the bearings:  
Bearing 2 located at 28.7' (blocking >= 11.25" if used)

**Additional Notes**  
See DWGS A14015ENC160118 & GBLLETIN0118 for gable wind bracing and other requirements.

B - C	259	-2483	E - J	59	-425
C - D	348	-2335	J - N	26	-468
D - E	80	-460			
<b>Maximum Bot Chord Forces Per Ply (lbs)</b>					
Chords	Tens.Comp.	Chords	Tens. Comp.		
B - S	2037	-102	R - Q	2033	-69
S - R	1445	0			
<b>Maximum Web Forces Per Ply (lbs)</b>					
Webs	Tens.Comp.	Webs	Tens. Comp.		
C - S	227	-544	D - W	397	-1976
S - D	830	-130	R - W	187	-515
D - R	748	-82	W - Q	428	-2079

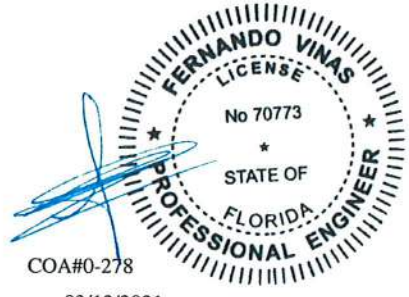

03/12/2021

**\*\*WARNING\*\* READ AND FOLLOW ALL NOTES ON THIS DRAWING!**  
**\*\*IMPORTANT\*\* FURNISH THIS DRAWING TO ALL CONTRACTORS INCLUDING THE INSTALLERS**  
Trusses require extreme care in fabricating, handling, shipping, installing and bracing. Refer to and follow the latest edition of BCSI (Building Component Safety Information, by TPI and SBCA) for safety practices prior to performing these functions. Installers shall provide temporary bracing per BCSI. Unless noted otherwise, top chord shall have properly attached structural sheathing and bottom chord shall have a properly attached rigid ceiling. Locations shown for permanent lateral restraint of webs shall have bracing installed per BCSI sections B3, B7, or B10, as applicable. Apply plates to each face of truss and position as shown above and on the Joint Details, unless noted otherwise. Refer to drawings 160A-Z for standard plate positions. Refer to job's General Notes page for additional information.  
Alpine, a division of ITW Building Components Group Inc, shall not be responsible for any deviation from this drawing, any failure to build the truss in conformance with ANSI/TPI 1, or for handling, shipping, installation and bracing of trusses. A seal on this drawing or cover page listing this drawing, indicates acceptance of professional engineering responsibility solely for the design shown. The suitability and use of this drawing for any structure is the responsibility of the Building Designer per ANSI/TPI 1 Sec.2.  
For more information see these web sites: Alpine: alpineitw.com; TPI: tpinst.org; SBCA: sbcindustry.com; ICC: iccsafe.org; AWC: awc.org



SEQN: 32984 FROM: RJL	COMN Ply: 1 Qty: 10	Job Number: B53089a DANIELLO RESIDENCE Truss Label: A2 34' Common	Cust: R 857 JRef: 1X3N8570007 T3 DrwNo: 071.21.1556.48187 JB / FV 03/12/2021
--------------------------	---------------------------	---	--

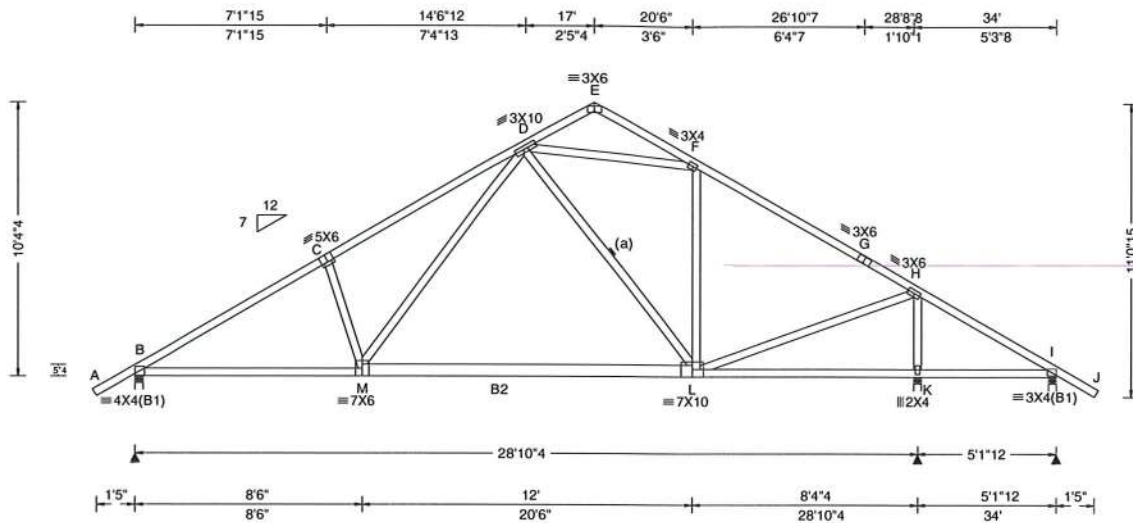

<b>Loading Criteria (psf)</b> TCLL: 20.00 TCDL: 7.00 BCLL: 0.00 BCDL: 10.00 Des Ld: 37.00 NCBCLL: 10.00 Soffit: 0.00 Load Duration: 1.25 Spacing: 24.0 "	<b>Wind Criteria</b> Wind Std: ASCE 7-16 Speed: 130 mph Enclosure: Closed Risk Category: II EXP: B Kzt: NA Mean Height: 15.00 ft TCDL: 4.2 psf BCDL: 5.2 psf MWFRS Parallel Dist: h to 2h C&C Dist a: 3.40 ft Loc. from endwall: not in 9.00 ft GCpi: 0.18 Wind Duration: 1.60	<b>Snow Criteria (Pg,Pf in PSF)</b> Pg: NA Ct: NA CAT: NA Pf: NA Ce: NA Lu: NA Cs: NA Snow Duration: NA  Building Code: FBC 7th Ed. 2020 Res. TPI Std: 2014 Rep Fac: No FT/RT:20(0)/10(0) Plate Type(s): WAVE	<b>Defl/CSI Criteria</b> PP Deflection in loc L/defl L/# VERT(LL): 0.076 M 999 360 VERT(CL): 0.132 M 999 240 HORZ(LL): 0.026 C - - HORZ(TL): 0.045 C - - Creep Factor: 2.0 Max TC CSI: 0.599 Max BC CSI: 0.745 Max Web CSI: 0.718  VIEW Ver: 20.02.00A.1020.20	<b>▲ Maximum Reactions (lbs)</b> Gravity Non-Gravity Loc R+ / R- / Rh / Rw / U / RL B 1296 /- /- /639 /- /208 K 1560 /- /- /716 /- /- I 253 /-36 /- /125 /16 /- Wind reactions based on MWFRS B Brg Width = 3.5 Min Req = 1.5 K Brg Width = 3.5 Min Req = 1.5 I Brg Width = 3.5 Min Req = 1.5 Bearings B, K, & I are a rigid surface. Members not listed have forces less than 375# <b>Maximum Top Chord Forces Per Ply (lbs)</b> Chords Tens.Comp. Chords Tens. Comp. B - C 125 -1951 F - G 117 -1167 C - D 194 -1830 G - H 86 -1221  <b>Maximum Bot Chord Forces Per Ply (lbs)</b> Chords Tens.Comp. Chords Tens. Comp. B - M 1598 -16 M - L 1013 0  <b>Maximum Web Forces Per Ply (lbs)</b> Webs Tens.Comp. Webs Tens. Comp. M - D 832 -47 L - H 1152 0 D - F 195 -957 H - K 167 -1443
---	---	---	---	---

**Lumber**

Top chord: 2x4 SP #1;  
Bot chord: 2x4 SP #1; B2 2x6 SP #1;  
Webs: 2x4 SP #3;

**Bracing**

(a) Continuous lateral restraint equally spaced on member. Or 2x4 #3 or better "T" reinforcement. 80% length of web member. Attached with 10d Box or Gun (0.128"x3",min.)nails @ 6" oc.

**Loading**

Truss passed check for 20 psf additional bottom chord live load in areas with 42"-high x 24"-wide clearance.

**Wind**

Wind loads based on MWFRS with additional C&C member design.  
Wind loading based on both gable and hip roof types.

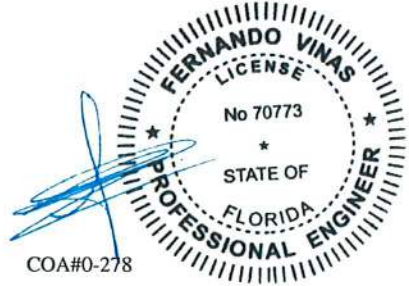

COA#0-278

03/12/2021

**\*\*WARNING\*\* READ AND FOLLOW ALL NOTES ON THIS DRAWING!**  
**\*\*IMPORTANT\*\* FURNISH THIS DRAWING TO ALL CONTRACTORS INCLUDING THE INSTALLERS**  
Trusses require extreme care in fabricating, handling, shipping, installing and bracing. Refer to and follow the latest edition of BCSI (Building Component Safety Information, by TPI and SBCA) for safety practices prior to performing these functions. Installers shall provide temporary bracing per BCSI. Unless noted otherwise, top chord shall have properly attached structural sheathing and bottom chord shall have a properly attached rigid ceiling. Locations shown for permanent lateral restraint of webs shall have bracing installed per BCSI sections B3, B7, or B10, as applicable. Apply plates to each face of truss and position as shown above and on the Joint Details, unless noted otherwise. Refer to drawings 160A-Z for standard plate positions. Refer to job's General Notes page for additional information.  
Alpine, a division of ITW Building Components Group Inc. shall not be responsible for any deviation from this drawing, any failure to build the truss in conformance with ANSI/TPI 1, or for handling, shipping, installation and bracing of trusses. A seal on this drawing or cover page listing this drawing, indicates acceptance of professional engineering responsibility solely for the design shown. The suitability and use of this drawing for any structure is the responsibility of the Building Designer per ANSI/TPI 1 Sec.2.  
For more information see these web sites: Alpine: alpineitw.com; TPI: tpinst.org; SBCA: sbcindustry.com; ICC: iccsafe.org; AWC: awc.org



SEQN: 32985 FROM: RJL	GABL Ply: 1 Qty: 2	Job Number: B53089a DANIELLO RESIDENCE Truss Label: B1-G 29' Gable	Cust: R 857 JRef: 1X3N8570007 T2 DrwNo: 071.21.1556.51103 JB / FV 03/12/2021
--------------------------	--------------------------	--	--

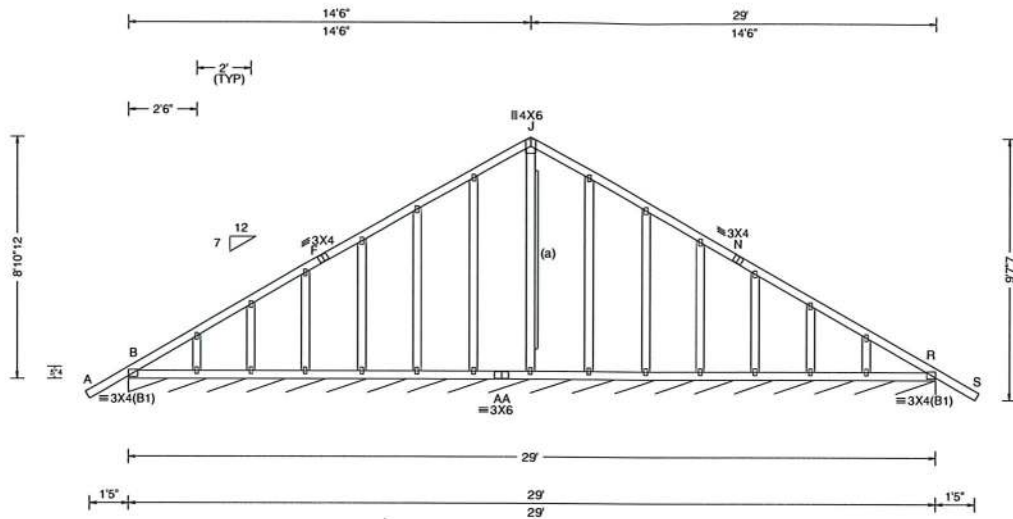

<b>Loading Criteria (psf)</b> TCLL: 20.00 TCCL: 7.00 BCLL: 0.00 BCDL: 10.00 Des Ld: 37.00 NCBCLL: 10.00 Soffit: 0.00 Load Duration: 1.25 Spacing: 24.0"	<b>Wind Criteria</b> Wind Std: ASCE 7-16 Speed: 130 mph Enclosure: Closed Risk Category: II EXP: B Kzt: NA Mean Height: 15.00 ft TCDL: 4.2 psf BCDL: 5.2 psf MWFRS Parallel Dist: 0 to h/2 C&C Dist a: 3.00 ft Loc. from endwall: Any GCpi: 0.18 Wind Duration: 1.60	<b>Snow Criteria (Pg,Pf in PSF)</b> Pg: NA Ct: NA CAT: NA Pf: NA Ce: NA Lu: NA Cs: NA Snow Duration: NA  Building Code: FBC 7th Ed. 2020 Res. TPI Std: 2014 Rep Fac: No FT/RT:20(0)/10(0) Plate Type(s): WAVE	<b>Defl/CSI Criteria</b> PP Deflection in loc L/defl L/# VERT(LL): 0.001 K 999 360 VERT(CL): 0.003 K 999 240 HORZ(LL): 0.002 O - - HORZ(TL): 0.003 L - - Creep Factor: 2.0 Max TC CSI: 0.125 Max BC CSI: 0.030 Max Web CSI: 0.138  VIEW Ver: 20.02.00A.1020.20	<b>▲ Maximum Reactions (lbs), or * = PLF</b> Gravity Non-Gravity Loc R+ / R- / Rh / Rw / U / RL R* 103 / - / - / 41 / 7 / 7 Wind reactions based on MWFRS R Brg Width = 348 Min Req = - Bearing B is a rigid surface. Members not listed have forces less than 375#
--	---	---	---	--

**Lumber**

Top chord: 2x4 SP #1;  
Bot chord: 2x4 SP #1;  
Webs: 2x4 SP #3;

**Bracing**

(a) 1x4 #3SRB SPF-S or better "L" reinforcement. 80% length of web member. Attach with 8d Box or Gun (0.113"x2.5",min.)nails @ 6" oc.

**Plating Notes**

All plates are 1.5X3 except as noted.

**Loading**

Truss designed to support 1-0-0 top chord outlookers and cladding load not to exceed 5.00 PSF one face and 24.0" span opposite face. Top chord must not be cut or notched, unless specified otherwise.

**Wind**

Wind loads based on MWFRS with additional C&C member design.  
Wind loading based on both gable and hip roof types.

**Additional Notes**

See DWGS A14015ENC160118 & GBLLETIN0118 for gable wind bracing and other requirements.

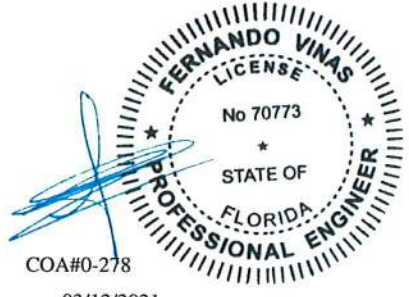

03/12/2021

**\*\*WARNING\*\* READ AND FOLLOW ALL NOTES ON THIS DRAWING!**  
**\*\*IMPORTANT\*\* FURNISH THIS DRAWING TO ALL CONTRACTORS INCLUDING THE INSTALLERS**  
Trusses require extreme care in fabricating, handling, shipping, installing and bracing. Refer to and follow the latest edition of BCSI (Building Component Safety Information, by TPI and SBCA) for safety practices prior to performing these functions. Installers shall provide temporary bracing per BCSI. Unless noted otherwise, top chord shall have properly attached structural sheathing and bottom chord shall have a properly attached rigid ceiling. Locations shown for permanent lateral restraint of webs shall have bracing installed per BCSI sections B3, B7, or B10, as applicable. Apply plates to each face of truss and position as shown above and on the Joint Details, unless noted otherwise. Refer to drawings 160A-Z for standard plate positions. Refer to job's General Notes page for additional information.  
Alpine, a division of ITW Building Components Group Inc. shall not be responsible for any deviation from this drawing, any failure to build the truss in conformance with ANSI/TPI 1, or for handling, shipping, installation and bracing of trusses. A seal on this drawing or cover page listing this drawing, indicates acceptance of professional engineering responsibility solely for the design shown. The suitability and use of this drawing for any structure is the responsibility of the Building Designer per ANSI/TPI 1 Sec.2.  
For more information see these web sites: Alpine: alpineitw.com; TPI: tpinst.org; SBCA: sbcindustry.com; ICC: iccsafe.org; AWC: awc.org



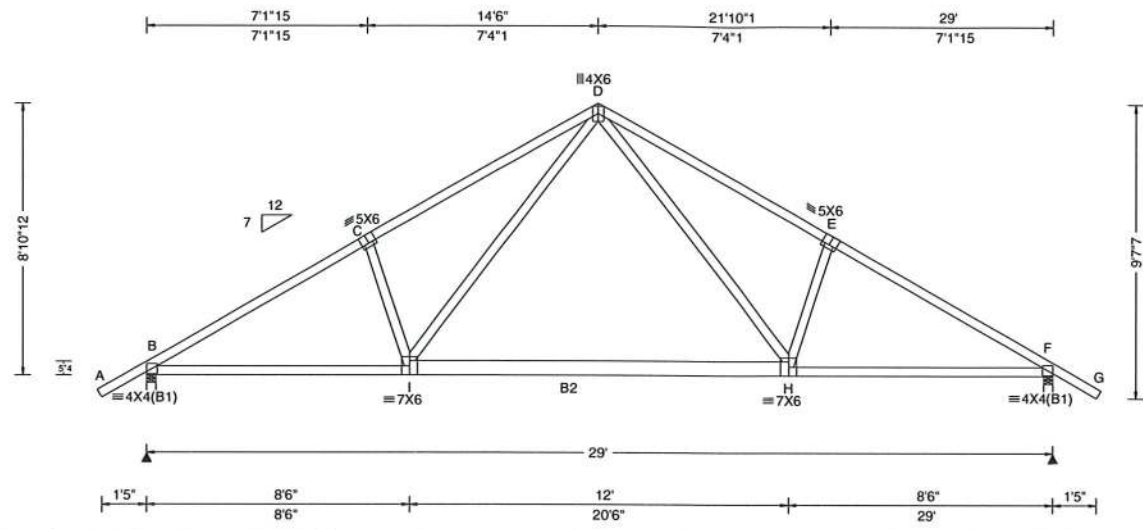

<b>Loading Criteria (psf)</b> TCLL: 20.00 TCDL: 7.00 BCLL: 0.00 BCDL: 10.00 Des Ld: 37.00 NCBCLL: 10.00 Soffit: 0.00 Load Duration: 1.25 Spacing: 24.0 "	<b>Wind Criteria</b> Wind Std: ASCE 7-16 Speed: 130 mph Enclosure: Closed Risk Category: II EXP: B Kzt: NA Mean Height: 15.00 ft TCDL: 4.2 psf BCDL: 5.2 psf MWFRS Parallel Dist: 0 to h/2 C&C Dist a: 3.00 ft Loc. from endwall: Any GCpi: 0.18 Wind Duration: 1.60	<b>Snow Criteria (Pg,Pf in PSF)</b> Pg: NA Ct: NA CAT: NA Pf: NA Ce: NA Lu: NA Cs: NA Snow Duration: NA  Building Code: FBC 7th Ed. 2020 Res. TPI Std: 2014 Rep Fac: No FT/RT:20(0)/10(0) Plate Type(s): WAVE	<b>Defl/CSI Criteria</b> PP Deflection in loc L/defl L/# VERT(LL): 0.091 I 999 360 VERT(CL): 0.156 I 999 240 HORZ(LL): 0.036 H - - HORZ(TL): 0.062 H - - Creep Factor: 2.0 Max TC CSI: 0.471 Max BC CSI: 0.764 Max Web CSI: 0.315  VIEW Ver: 20.02.00A.1020.20	<b>▲ Maximum Reactions (lbs)</b> Gravity Non-Gravity Loc R+ / R- / Rh / Rw / U / RL B 1318 /- /- /631 /70 /179 F 1318 /- /- /631 /70 /- Wind reactions based on MWFRS B Brg Width = 3.5 Min Req = 1.6 F Brg Width = 3.5 Min Req = 1.6 Bearings B & F are a rigid surface. Members not listed have forces less than 375# <b>Maximum Top Chord Forces Per Ply (lbs)</b> Chords Tens.Comp. Chords Tens. Comp. B - C 240 - 1992 D - E 318 - 1870 C - D 318 - 1870 E - F 240 - 1992
---	---	---	---	---

**Lumber**  
Top chord: 2x4 SP #1;  
Bot chord: 2x4 SP #1; B2 2x6 SP #1;  
Webs: 2x4 SP #3;

**Loading**  
Truss passed check for 20 psf additional bottom chord live load in areas with 42"-high x 24"-wide clearance.

**Wind**  
Wind loads based on MWFRS with additional C&C member design.  
Wind loading based on both gable and hip roof types.

**Maximum Bot Chord Forces Per Ply (lbs)**

Chords	Tens.Comp.	Chords	Tens. Comp.
B - I	1633 -99	H - F	1633 - 105
I - H	1052 0		

**Maximum Web Forces Per Ply (lbs)**

Webs	Tens.Comp.	Webs	Tens. Comp.
I - D	827 -96	D - H	827 -96

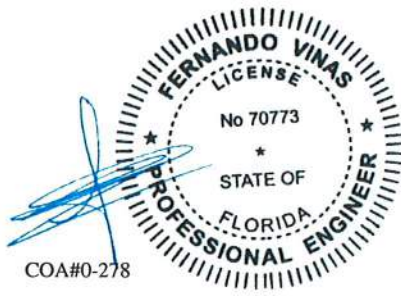

03/12/2021

**\*\*WARNING\*\*** READ AND FOLLOW ALL NOTES ON THIS DRAWING!  
**\*\*IMPORTANT\*\*** FURNISH THIS DRAWING TO ALL CONTRACTORS INCLUDING THE INSTALLERS  
Trusses require extreme care in fabricating, handling, shipping, installing and bracing. Refer to and follow the latest edition of BCSI (Building Component Safety Information, by TPI and SBCA) for safety practices prior to performing these functions. Installers shall provide temporary bracing per BCSI. Unless noted otherwise, top chord shall have properly attached structural sheathing and bottom chord shall have a properly attached rigid ceiling. Locations shown for permanent lateral restraint of webs shall have bracing installed per BCSI sections B3, B7, or B10, as applicable. Apply plates to each face of truss and position as shown above and on the Joint Details, unless noted otherwise. Refer to drawings 160A-Z for standard plate positions. Refer to job's General Notes page for additional information.  
Alpine, a division of ITW Building Components Group Inc, shall not be responsible for any deviation from this drawing, any failure to build the truss in conformance with ANSI/TPI 1, or for handling, shipping, installation and bracing of trusses. A seal on this drawing or cover page listing this drawing, indicates acceptance of professional engineering responsibility solely for the design shown. The suitability and use of this drawing for any structure is the responsibility of the Building Designer per ANSI/TPI 1 Sec.2.  
For more information see these web sites: Alpine: alpineitw.com; TPI: tpinst.org; SBCA: sbcinustry.com; ICC: iccsafe.org; AWC: awc.org





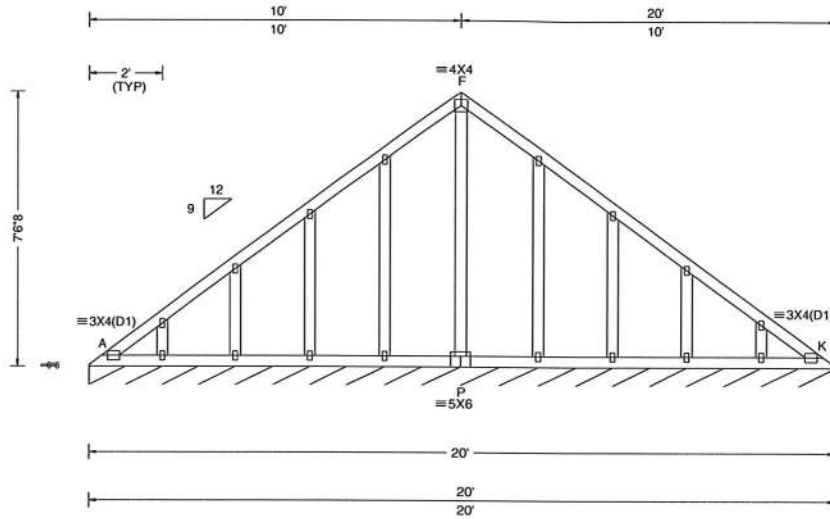

<b>Loading Criteria (psf)</b> TCLL: 20.00 TCCL: 7.00 BCLL: 0.00 BCDL: 10.00 Des Ld: 37.00 NCBCLL: 10.00 Soffit: 0.00 Load Duration: 1.25 Spacing: 24.0 *	<b>Wind Criteria</b> Wind Std: ASCE 7-16 Speed: 130 mph Enclosure: Closed Risk Category: II EXP: B Kzt: NA Mean Height: 15.00 ft TCDL: 4.2 psf BCDL: 5.2 psf MWFRS Parallel Dist: 0 to h/2 C&C Dist a: 3.00 ft Loc. from endwall: Any GCpi: 0.18 Wind Duration: 1.60	<b>Snow Criteria (Pg,Pf in PSF)</b> Pg: NA Ct: NA CAT: NA Pf: NA Ce: NA Lu: NA Cs: NA Snow Duration: NA  <b>Building Code:</b> FBC 7th Ed. 2020 Res. TPI Std: 2014 Rep Fac: No FT/RT:20(0)/10(0) Plate Type(s): WAVE	<b>Defl/CSI Criteria</b> PP Deflection in loc L/defl L/# VERT(LL): 0.001 E 999 360 VERT(CL): 0.002 E 999 240 HORZ(LL): -0.001 D - - HORZ(TL): 0.002 E - - Creep Factor: 2.0 Max TC CSI: 0.064 Max BC CSI: 0.027 Max Web CSI: 0.137  VIEW Ver: 20.02.00A.1020.20	<b>▲ Maximum Reactions (lbs), or *PLF</b> <table border="1"> <thead> <tr> <th rowspan="2">Loc</th> <th colspan="3">Gravity</th> <th colspan="3">Non-Gravity</th> </tr> <tr> <th>R+</th> <th>/R-</th> <th>/Rh</th> <th>/Rw</th> <th>/U</th> <th>/RL</th> </tr> </thead> <tbody> <tr> <td>K* 94</td> <td>-</td> <td>-</td> <td>/41</td> <td>/4</td> <td>/8</td> <td></td> </tr> </tbody> </table> Wind reactions based on MWFRS K Brg Width = 240 Min Req = - Bearing A is a rigid surface. Members not listed have forces less than 375#	Loc	Gravity			Non-Gravity			R+	/R-	/Rh	/Rw	/U	/RL	K* 94	-	-	/41	/4	/8	
Loc	Gravity			Non-Gravity																				
	R+	/R-	/Rh	/Rw	/U	/RL																		
K* 94	-	-	/41	/4	/8																			

**Lumber**  
 Top chord: 2x4 SP #1;  
 Bot chord: 2x4 SP #1;  
 Webs: 2x4 SP #3;

**Plating Notes**  
 All plates are 1.5X3 except as noted.

**Loading**  
 Truss designed to support 1-0-0 top chord outlookers and cladding load not to exceed 5.00 PSF one face and 24.0" span opposite face. Top chord must not be cut or notched, unless specified otherwise.

**Wind**  
 Wind loads based on MWFRS with additional C&C member design.  
 Wind loading based on both gable and hip roof types.

**Additional Notes**  
 See DWGS A14015ENC160118 & GBLLETIN0118 for gable wind bracing and other requirements.

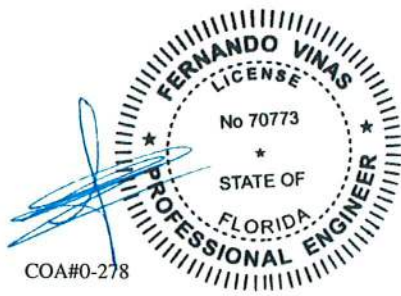

03/12/2021

**\*\*WARNING\*\*** READ AND FOLLOW ALL NOTES ON THIS DRAWING!  
**\*\*IMPORTANT\*\*** FURNISH THIS DRAWING TO ALL CONTRACTORS INCLUDING THE INSTALLERS  
 Trusses require extreme care in fabricating, handling, shipping, installing and bracing. Refer to and follow the latest edition of BCSI (Building Component Safety Information, by TPI and SBCA) for safety practices prior to performing these functions. Installers shall provide temporary bracing per BCSI. Unless noted otherwise, top chord shall have properly attached structural sheathing and bottom chord shall have a properly attached rigid ceiling. Locations shown for permanent lateral restraint of webs shall have bracing installed per BCSI sections B3, B7, or B10, as applicable. Apply plates to each face of truss and position as shown above and on the Joint Details, unless noted otherwise. Refer to drawings 160A-Z for standard plate positions. Refer to job's General Notes page for additional information.  
 Alpine, a division of ITW Building Components Group Inc. shall not be responsible for any deviation from this drawing, any failure to build the truss in conformance with ANSI/TPI 1, or for handling, shipping, installation and bracing of trusses. A seal on this drawing or cover page listing this drawing, indicates acceptance of professional engineering responsibility solely for the design shown. The suitability and use of this drawing for any structure is the responsibility of the Building Designer per ANSI/TPI 1 Sec.2.  
 For more information see these web sites: Alpine: alpineitw.com; TPI: tpinst.org; SBCA: sbcindustry.com; ICC: iccsafe.org; AWC: awc.org



# Gable Stud Reinforcement Detail

ASCE 7-16: 140 mph Wind Speed, 15' Mean Height, Enclosed, Exposure C, Kzt = 1.00

- Dir: 120 mph Wind Speed, 15' Mean Height, Partially Enclosed, Exposure C, Kzt = 1.00
- Dir: 120 mph Wind Speed, 15' Mean Height, Enclosed, Exposure D, Kzt = 1.00
- Dir: 100 mph Wind Speed, 15' Mean Height, Partially Enclosed, Exposure D, Kzt = 1.00

Gable Vertical Spacing	2x4 Species	Brace Grade	No Braces									
			Group A	Group B	Group A	Group B	Group A	Group B	Group A	Group B	Group A	Group B
12" o.c.	SPF	#1 / #2	7' 3"	7' 7"	8' 7"	10' 3"	10' 8"	13' 6"	14' 0"	14' 0"	14' 0"	14' 0"
			6' 7"	7' 1"	8' 6"	10' 1"	10' 6"	13' 10"	14' 0"	14' 0"	14' 0"	14' 0"
12" o.c.	HF	Standard	4' 1"	4' 1"	4' 1"	4' 1"	4' 1"	4' 1"	4' 1"	4' 1"	4' 1"	4' 1"
			4' 1"	4' 1"	4' 1"	4' 1"	4' 1"	4' 1"	4' 1"	4' 1"	4' 1"	4' 1"
12" o.c.	SP	#1	7' 4"	7' 8"	8' 8"	10' 4"	10' 9"	13' 8"	14' 0"	14' 0"	14' 0"	14' 0"
			6' 0"	6' 4"	7' 4"	9' 0"	9' 5"	12' 5"	13' 4"	14' 0"	14' 0"	14' 0"
12" o.c.	DFL	Standard	4' 2"	4' 2"	4' 2"	4' 2"	4' 2"	4' 2"	4' 2"	4' 2"	4' 2"	4' 2"
			4' 2"	4' 2"	4' 2"	4' 2"	4' 2"	4' 2"	4' 2"	4' 2"	4' 2"	4' 2"
16" o.c.	SPF	#1 / #2	8' 4"	8' 8"	9' 10"	10' 3"	11' 8"	12' 2"	14' 0"	14' 0"	14' 0"	14' 0"
			7' 0"	7' 4"	8' 6"	9' 6"	11' 0"	11' 10"	14' 0"	14' 0"	14' 0"	14' 0"
16" o.c.	HF	Standard	4' 8"	4' 8"	4' 8"	4' 8"	4' 8"	4' 8"	4' 8"	4' 8"	4' 8"	4' 8"
			4' 8"	4' 8"	4' 8"	4' 8"	4' 8"	4' 8"	4' 8"	4' 8"	4' 8"	4' 8"
16" o.c.	SP	#1	8' 5"	8' 9"	9' 11"	11' 10"	12' 4"	14' 0"	14' 0"	14' 0"	14' 0"	
			7' 9"	8' 3"	9' 5"	10' 2"	11' 8"	12' 1"	14' 0"	14' 0"	14' 0"	14' 0"
16" o.c.	DFL	Standard	5' 1"	5' 1"	5' 1"	5' 1"	5' 1"	5' 1"	5' 1"	5' 1"	5' 1"	5' 1"
			5' 1"	5' 1"	5' 1"	5' 1"	5' 1"	5' 1"	5' 1"	5' 1"	5' 1"	5' 1"
12" o.c.	SPF	#1 / #2	9' 0"	9' 4"	10' 8"	11' 3"	11' 8"	13' 5"	14' 0"	14' 0"	14' 0"	14' 0"
			8' 0"	8' 4"	9' 8"	10' 3"	10' 8"	12' 5"	13' 0"	14' 0"	14' 0"	14' 0"
12" o.c.	HF	Standard	5' 1"	5' 1"	5' 1"	5' 1"	5' 1"	5' 1"	5' 1"	5' 1"	5' 1"	5' 1"
			5' 1"	5' 1"	5' 1"	5' 1"	5' 1"	5' 1"	5' 1"	5' 1"	5' 1"	5' 1"
12" o.c.	SP	#1	9' 2"	9' 6"	10' 10"	11' 3"	11' 8"	13' 5"	14' 0"	14' 0"	14' 0"	14' 0"
			8' 2"	8' 6"	9' 10"	10' 3"	10' 8"	12' 5"	13' 0"	14' 0"	14' 0"	14' 0"
12" o.c.	DFL	Standard	5' 3"	5' 3"	5' 3"	5' 3"	5' 3"	5' 3"	5' 3"	5' 3"	5' 3"	5' 3"
			5' 3"	5' 3"	5' 3"	5' 3"	5' 3"	5' 3"	5' 3"	5' 3"	5' 3"	5' 3"

Bracing Group Species and Grades		Group A		Group B	
Spruce-Pine-Fir	#1 / #2	Standard	Standard	Standard	Standard
	#3	Stud	Stud	Stud	Stud
Douglas Fir-Larch	#3	Stud	Stud	Stud	Stud
	Standard	Standard	Standard	Standard	Standard
Southern Pine		#3	Stud	Standard	Standard

1x4 Braces shall be SRB (Stress-Rated Board).  
 For 1x4 So. Pine use only Industrial S5 or Industrial 45 Stress-Rated Boards. Group B values may be used with these grades.

**Gable Truss Detail Notes:**  
 Wind Load deflection criterion is L/240.  
 Provide uplift connections for SS pif over continuous bearing (5 psf TC Dead Load).  
 Gable end supports load from 4' 0" outcrookers with 2' 0" overhang, or 12" plywood overhang.

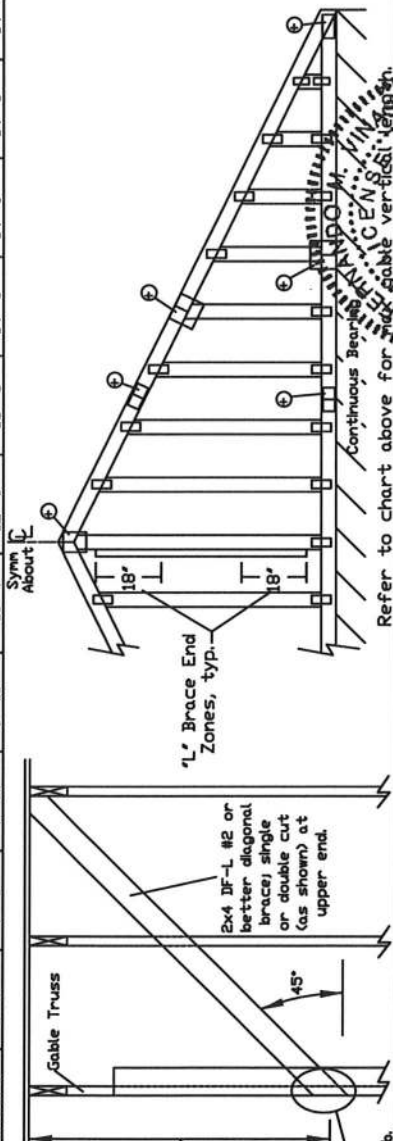

REF	ASCE7-16-GABI4015
DATE	01/26/2018
DRWG	A14015ENC160118

No 70773

\* STATE OF FLORIDA \*  
 PROFESSIONAL ENGINEER  
 03/12/2021

MAX. TOT. L.D. 60 PSF  
 MAX. SPACING 24.0"

**ALPINE**  
 AN ITW COMPANY  
 115141 Earth City Expressway  
 115141 Earth City, MO 63045

**WARNING: READ AND FOLLOW ALL NOTES ON THIS DRAWING TO ALL CONTRACTORS INCLUDING THE INSTALLERS.**  
 Trusses require extreme care in fabricating, handling, shipping, installing and bracing. Refer to and follow the latest edition of ICCI Building Component Safety Information, by TPI and SBCA for safety practices prior to performing these functions. Installers shall provide temporary bracing per ICCI. Unless noted otherwise, top chord shall have properly attached structural sheathing and bottom chord shall have bracing installed per ICCI sections 33, 37 or 310, as applicable. Apply plates to each face of truss and position as shown above and on the Joint Details, unless noted otherwise.  
 Refer to drawings 160A-Z for standard plate positions.  
 Alpine, a division of ITW Building Components Group Inc. shall not be responsible for any deviation from this drawing, any failure to build the truss in conformance with ANSI/TPI 1, or for handling, shipping, installation, bracing or trusses.  
 The undersigned hereby certifies that the design shown on this page listing the manufacturer of professional engineering structure is the responsibility of the Building Designer per ANSI/TPI 1 Sec.2  
 For more information see this job's general notes page and these web sites  
 ALPINE: www.alphite.com TPI: www.tpi.net SBCA: www.sbcachicago.org ICCI: www.iccifair.org

# Gable Detail For Let-in Verticals

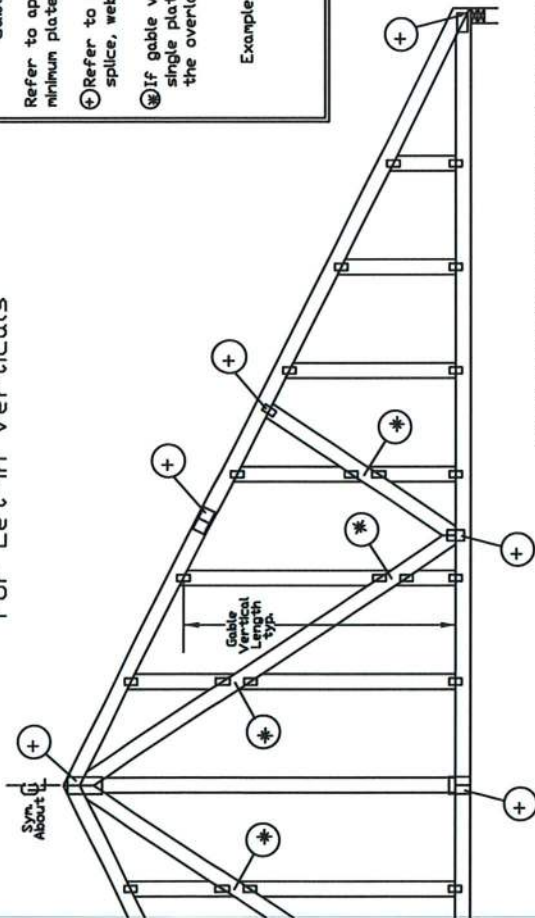

## Gable Truss Plate Sizes

Refer to appropriate Alpine gable detail for minimum plate sizes for vertical studs.

⊕ Refer to Engineered truss design for peak, splice, web, and heel plates.

⊗ If gable vertical plates overlap, use a single plate that covers the total area of the overlapped plates to span the web.

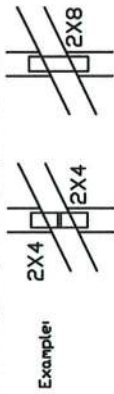

Example:

## 'T' Reinforcement Attachment Detail

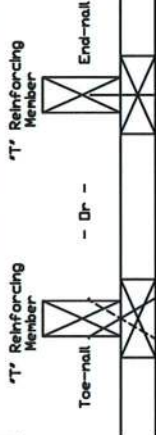

To convert from 'L' to 'T' reinforcing members, multiply 'T' increase by length based on appropriate Alpine gable detail.

Maximum allowable 'T' reinforced gable vertical length is 14' from top to bottom chord.

'T' reinforcing member material must match size, specie, and grade of the 'L' reinforcing member.

## Web Length Increase w/ 'T' Brace

'T' Reinf. Mbr. Size	'T' Increase
2x4	30 %
2x6	20 %

Examples:

ASCE 7-10 Wind Speed = 120 mph

Mean Roof Height = 30 ft, Kzt = 1.00

Gable Vertical = 24' o.c. SP #3

'T' Reinforcing Member Size = 2x4

'T' Brace Increase (From Above) = 30% = 1.30

(1) 2x4 'L' Brace Length = 8' 7"

Maximum 'T' Reinforced Gable Vertical Length = 1.30 x 8' 7" = 11' 2"

Provide connections for uplift specified on the engineered truss design.

Attach each 'T' reinforcing member with

End Driven Nails:

10d Common (0.148" x 3.7" min) Nails at 4' o.c. plus

(4) nails in the top and bottom chords.

Toenailed Nails:

10d Common (0.148" x 3.7" min) Toenails at 4' o.c. plus

(4) toenails in the top and bottom chords.

This detail to be used with the appropriate Alpine gable detail for ASCE wind load.

ASCE 7-05 Gable Detail Drawings

A13015051014, A12015051014, A11015051014, A10015051014, A14015051014, A13030051014, A12030051014, A11030051014, A10030051014, A14030051014

ASCE 7-10 & ASCE 7-16 Gable Detail Drawings

A11515ENC100118, A12015ENC100118, A14015ENC100118, A16015ENC100118, A18015ENC100118, A20015ENC100118, A22015ENC100118, A24015ENC100118, A26015ENC100118, A28015ENC100118, A30015ENC100118, A32015ENC100118, A34015ENC100118, A36015ENC100118, A38015ENC100118, A40015ENC100118, A42015ENC100118, A44015ENC100118, A46015ENC100118, A48015ENC100118, A50015ENC100118, A52015ENC100118, A54015ENC100118, A56015ENC100118, A58015ENC100118, A60015ENC100118, A62015ENC100118, A64015ENC100118, A66015ENC100118, A68015ENC100118, A70015ENC100118, A72015ENC100118, A74015ENC100118, A76015ENC100118, A78015ENC100118, A80015ENC100118, A82015ENC100118, A84015ENC100118, A86015ENC100118, A88015ENC100118, A90015ENC100118, A92015ENC100118, A94015ENC100118, A96015ENC100118, A98015ENC100118, A100015ENC100118, A102015ENC100118, A104015ENC100118, A106015ENC100118, A108015ENC100118, A110015ENC100118, A112015ENC100118, A114015ENC100118, A116015ENC100118, A118015ENC100118, A120015ENC100118, A122015ENC100118, A124015ENC100118, A126015ENC100118, A128015ENC100118, A130015ENC100118, A132015ENC100118, A134015ENC100118, A136015ENC100118, A138015ENC100118, A140015ENC100118, A142015ENC100118, A144015ENC100118, A146015ENC100118, A148015ENC100118, A150015ENC100118, A152015ENC100118, A154015ENC100118, A156015ENC100118, A158015ENC100118, A160015ENC100118, A162015ENC100118, A164015ENC100118, A166015ENC100118, A168015ENC100118, A170015ENC100118, A172015ENC100118, A174015ENC100118, A176015ENC100118, A178015ENC100118, A180015ENC100118, A182015ENC100118, A184015ENC100118, A186015ENC100118, A188015ENC100118, A190015ENC100118, A192015ENC100118, A194015ENC100118, A196015ENC100118, A198015ENC100118, A200015ENC100118, A202015ENC100118, A204015ENC100118, A206015ENC100118, A208015ENC100118, A210015ENC100118, A212015ENC100118, A214015ENC100118, A216015ENC100118, A218015ENC100118, A220015ENC100118, A222015ENC100118, A224015ENC100118, A226015ENC100118, A228015ENC100118, A230015ENC100118, A232015ENC100118, A234015ENC100118, A236015ENC100118, A238015ENC100118, A240015ENC100118, A242015ENC100118, A244015ENC100118, A246015ENC100118, A248015ENC100118, A250015ENC100118, A252015ENC100118, A254015ENC100118, A256015ENC100118, A258015ENC100118, A260015ENC100118, A262015ENC100118, A264015ENC100118, A266015ENC100118, A268015ENC100118, A270015ENC100118, A272015ENC100118, A274015ENC100118, A276015ENC100118, A278015ENC100118, A280015ENC100118, A282015ENC100118, A284015ENC100118, A286015ENC100118, A288015ENC100118, A290015ENC100118, A292015ENC100118, A294015ENC100118, A296015ENC100118, A298015ENC100118, A300015ENC100118, A302015ENC100118, A304015ENC100118, A306015ENC100118, A308015ENC100118, A310015ENC100118, A312015ENC100118, A314015ENC100118, A316015ENC100118, A318015ENC100118, A320015ENC100118, A322015ENC100118, A324015ENC100118, A326015ENC100118, A328015ENC100118, A330015ENC100118, A332015ENC100118, A334015ENC100118, A336015ENC100118, A338015ENC100118, A340015ENC100118, A342015ENC100118, A344015ENC100118, A346015ENC100118, A348015ENC100118, A350015ENC100118, A352015ENC100118, A354015ENC100118, A356015ENC100118, A358015ENC100118, A360015ENC100118, A362015ENC100118, A364015ENC100118, A366015ENC100118, A368015ENC100118, A370015ENC100118, A372015ENC100118, A374015ENC100118, A376015ENC100118, A378015ENC100118, A380015ENC100118, A382015ENC100118, A384015ENC100118, A386015ENC100118, A388015ENC100118, A390015ENC100118, A392015ENC100118, A394015ENC100118, A396015ENC100118, A398015ENC100118, A400015ENC100118, A402015ENC100118, A404015ENC100118, A406015ENC100118, A408015ENC100118, A410015ENC100118, A412015ENC100118, A414015ENC100118, A416015ENC100118, A418015ENC100118, A420015ENC100118, A422015ENC100118, A424015ENC100118, A426015ENC100118, A428015ENC100118, A430015ENC100118, A432015ENC100118, A434015ENC100118, A436015ENC100118, A438015ENC100118, A440015ENC100118, A442015ENC100118, A444015ENC100118, A446015ENC100118, A448015ENC100118, A450015ENC100118, A452015ENC100118, A454015ENC100118, A456015ENC100118, A458015ENC100118, A460015ENC100118, A462015ENC100118, A464015ENC100118, A466015ENC100118, A468015ENC100118, A470015ENC100118, A472015ENC100118, A474015ENC100118, A476015ENC100118, A478015ENC100118, A480015ENC100118, A482015ENC100118, A484015ENC100118, A486015ENC100118, A488015ENC100118, A490015ENC100118, A492015ENC100118, A494015ENC100118, A496015ENC100118, A498015ENC100118, A500015ENC100118, A502015ENC100118, A504015ENC100118, A506015ENC100118, A508015ENC100118, A510015ENC100118, A512015ENC100118, A514015ENC100118, A516015ENC100118, A518015ENC100118, A520015ENC100118, A522015ENC100118, A524015ENC100118, A526015ENC100118, A528015ENC100118, A530015ENC100118, A532015ENC100118, A534015ENC100118, A536015ENC100118, A538015ENC100118, A540015ENC100118, A542015ENC100118, A544015ENC100118, A546015ENC100118, A548015ENC100118, A550015ENC100118, A552015ENC100118, A554015ENC100118, A556015ENC100118, A558015ENC100118, A560015ENC100118, A562015ENC100118, A564015ENC100118, A566015ENC100118, A568015ENC100118, A570015ENC100118, A572015ENC100118, A574015ENC100118, A576015ENC100118, A578015ENC100118, A580015ENC100118, A582015ENC100118, A584015ENC100118, A586015ENC100118, A588015ENC100118, A590015ENC100118, A592015ENC100118, A594015ENC100118, A596015ENC100118, A598015ENC100118, A600015ENC100118, A602015ENC100118, A604015ENC100118, A606015ENC100118, A608015ENC100118, A610015ENC100118, A612015ENC100118, A614015ENC100118, A616015ENC100118, A618015ENC100118, A620015ENC100118, A622015ENC100118, A624015ENC100118, A626015ENC100118, A628015ENC100118, A630015ENC100118, A632015ENC100118, A634015ENC100118, A636015ENC100118, A638015ENC100118, A640015ENC100118, A642015ENC100118, A644015ENC100118, A646015ENC100118, A648015ENC100118, A650015ENC100118, A652015ENC100118, A654015ENC100118, A656015ENC100118, A658015ENC100118, A660015ENC100118, A662015ENC100118, A664015ENC100118, A666015ENC100118, A668015ENC100118, A670015ENC100118, A672015ENC100118, A674015ENC100118, A676015ENC100118, A678015ENC100118, A680015ENC100118, A682015ENC100118, A684015ENC100118, A686015ENC100118, A688015ENC100118, A690015ENC100118, A692015ENC100118, A694015ENC100118, A696015ENC100118, A698015ENC100118, A700015ENC100118, A702015ENC100118, A704015ENC100118, A706015ENC100118, A708015ENC100118, A710015ENC100118, A712015ENC100118, A714015ENC100118, A716015ENC100118, A718015ENC100118, A720015ENC100118, A722015ENC100118, A724015ENC100118, A726015ENC100118, A728015ENC100118, A730015ENC100118, A732015ENC100118, A734015ENC100118, A736015ENC100118, A738015ENC100118, A740015ENC100118, A742015ENC100118, A744015ENC100118, A746015ENC100118, A748015ENC100118, A750015ENC100118, A752015ENC100118, A754015ENC100118, A756015ENC100118, A758015ENC100118, A760015ENC100118, A762015ENC100118, A764015ENC100118, A766015ENC100118, A768015ENC100118, A770015ENC100118, A772015ENC100118, A774015ENC100118, A776015ENC100118, A778015ENC100118, A780015ENC100118, A782015ENC100118, A784015ENC100118, A786015ENC100118, A788015ENC100118, A790015ENC100118, A792015ENC100118, A794015ENC100118, A796015ENC100118, A798015ENC100118, A800015ENC100118, A802015ENC100118, A804015ENC100118, A806015ENC100118, A808015ENC100118, A810015ENC100118, A812015ENC100118, A814015ENC100118, A816015ENC100118, A818015ENC100118, A820015ENC100118, A822015ENC100118, A824015ENC100118, A826015ENC100118, A828015ENC100118, A830015ENC100118, A832015ENC100118, A834015ENC100118, A836015ENC100118, A838015ENC100118, A840015ENC100118, A842015ENC100118, A844015ENC100118, A846015ENC100118, A848015ENC100118, A850015ENC100118, A852015ENC100118, A854015ENC100118, A856015ENC100118, A858015ENC100118, A860015ENC100118, A862015ENC100118, A864015ENC100118, A866015ENC100118, A868015ENC100118, A870015ENC100118, A872015ENC100118, A874015ENC100118, A876015ENC100118, A878015ENC100118, A880015ENC100118, A882015ENC100118, A884015ENC100118, A886015ENC100118, A888015ENC100118, A890015ENC100118, A892015ENC100118, A894015ENC100118, A896015ENC100118, A898015ENC100118, A900015ENC100118, A902015ENC100118, A904015ENC100118, A906015ENC100118, A908015ENC100118, A910015ENC100118, A912015ENC100118, A914015ENC100118, A916015ENC100118, A918015ENC100118, A920015ENC100118, A922015ENC100118, A924015ENC100118, A926015ENC100118, A928015ENC100118, A930015ENC100118, A932015ENC100118, A934015ENC100118, A936015ENC100118, A938015ENC100118, A940015ENC100118, A942015ENC100118, A944015ENC100118, A946015ENC100118, A948015ENC100118, A950015ENC100118, A952015ENC100118, A954015ENC100118, A956015ENC100118, A958015ENC100118, A960015ENC100118, A962015ENC100118, A964015ENC100118, A966015ENC100118, A968015ENC100118, A970015ENC100118, A972015ENC100118, A974015ENC100118, A976015ENC100118, A978015ENC100118, A980015ENC100118, A982015ENC100118, A984015ENC100118, A986015ENC100118, A988015ENC100118, A990015ENC100118, A992015ENC100118, A994015ENC100118, A996015ENC100118, A998015ENC100118, A1000015ENC100118, A1002015ENC100118, A1004015ENC100118, A1006015ENC100118, A1008015ENC100118, A1010015ENC100118, A1012015ENC100118, A1014015ENC100118, A1016015ENC100118, A1018015ENC100118, A1020015ENC100118, A1022015ENC100118, A1024015ENC100118, A1026015ENC100118, A1028015ENC100118, A1030015ENC100118, A1032015ENC100118, A1034015ENC100118, A1036015ENC100118, A1038015ENC100118, A1040015ENC100118, A1042015ENC100118, A1044015ENC100118, A1046015ENC100118, A1048015ENC100118, A1050015ENC100118, A1052015ENC100118, A1054015ENC100118, A1056015ENC100118, A1058015ENC100118, A1060015ENC100118, A1062015ENC100118, A1064015ENC100118, A1066015ENC100118, A1068015ENC100118, A1070015ENC100118, A1072015ENC100118, A1074015ENC100118, A1076015ENC100118, A1078015ENC100118, A1080015ENC100118, A1082015ENC100118, A1084015ENC100118, A1086015ENC100118, A1088015ENC100118, A1090015ENC100118, A1092015ENC100118, A1094015ENC100118, A1096015ENC100118, A1098015ENC100118, A1100015ENC100118, A1102015ENC100118, A1104015ENC100118, A1106015ENC100118, A1108015ENC100118, A1110015ENC100118, A1112015ENC100118, A1114015ENC100118, A1116015ENC100118, A1118015ENC100118, A1120015ENC100118, A1122015ENC100118, A1124015ENC100118, A1126015ENC100118, A1128015ENC100118, A1130015ENC100118, A1132015ENC100118, A1134015ENC100118, A1136015ENC100118, A1138015ENC100118, A1140015ENC100118, A1142015ENC100118, A1144015ENC100118, A1146015ENC100118, A1148015ENC100118, A1150015ENC100118, A1152015ENC100118, A1154015ENC100118, A1156015ENC100118, A1158015ENC100118, A1160015ENC100118, A1162015ENC100118, A1164015ENC100118, A1166015ENC100118, A1168015ENC100118, A1170015ENC100118, A1172015ENC100118, A1174015ENC100118, A1176015ENC100118, A1178015ENC100118, A1180015ENC100118, A1182015ENC100118, A1184015ENC100118, A1186015ENC100118, A1188015ENC100118, A1190015ENC100118, A1192015ENC100118, A1194015ENC100118, A1196015ENC100118, A1198015ENC100118, A1200015ENC100118, A1202015ENC100118, A1204015ENC100118, A1206015ENC100118, A1208015ENC100118, A1210015ENC100118, A1212015ENC100118, A1214015ENC100118, A1216015ENC100118, A1218015ENC100118, A1220015ENC100118, A1222015ENC100118, A1224015ENC100118, A1226015ENC100118, A1228015ENC100118, A1230015ENC100118, A1232015ENC100118, A1234015ENC100118, A1236015ENC100118, A1238015ENC100118, A1240015ENC100118, A1242015ENC100118, A1244015ENC100118, A1246015ENC100118, A1248015ENC100118, A1250015ENC100118, A1252015ENC100118, A1254015ENC100118, A1256015ENC100118, A1258015ENC100118, A1260015ENC100118, A1262015ENC100118, A1264015ENC100118, A1266015ENC100118, A1268015ENC100118, A1270015ENC100118, A1272015ENC100118, A1274015ENC100118, A1276015ENC100118, A1278015ENC100118, A1280015ENC100118, A1282015ENC100118, A1284015ENC100118, A1286015ENC100118, A1288015ENC100118, A1290015ENC100118, A1292015ENC100118, A1294015ENC100118, A1296015ENC100118, A1298015ENC100118, A1300015ENC100118, A1302015ENC100118, A1304015ENC100118, A1306015ENC100118, A1308015ENC100118, A1310015ENC100118, A1312015ENC100118, A1314015ENC100118, A1316015ENC100118, A1318015ENC100118, A1320015ENC100118, A1322015ENC100118, A1324015ENC100118, A1326015ENC100118, A1328015ENC100118, A1330015ENC100118, A1332015ENC100118, A1334015ENC100118, A1336015ENC100118, A1338015ENC100118, A1340015ENC100118, A1342015ENC100118, A1344015ENC100118, A1346015ENC100118, A1348015ENC100118, A1350015ENC100118, A1352015ENC100118, A1354015ENC100118, A1356015ENC100118,

# Piggyback Detail - ASCE 7-16: 160 mph, 30' Mean Height, Enclosed, Exposure C, Kzt=1.00

160 mph Wind, 30.00 ft Mean Hgt, ASCE 7-16, Enclosed Bldg, located anywhere in roof, Exp C, Wind DL= 5.0 psf (min), Kzt=1.00  
 Dr= 140 mph Wind, 30.00 ft Mean Hgt, ASCE 7-16, Enclosed Bldg, located anywhere in roof, Exp D, Wind DL= 5.0 psf (min), Kzt=1.00

Note: Top chords of trusses supporting piggyback cap trusses must be adequately braced by sheathing or purlins. The Building Engineer of Record shall provide diagonal bracing or any other suitable anchorage to permanently restrain purlins, and lateral bracing for out of plane loads over gable ends. Maximum truss spacing is 24' o.c. detail is not applicable if cap supports additional loads such as cupola, steeple, chimney or drag strut loads.

Refer to Engineer's sealed truss design drawing for piggyback and base truss specifications.

## Detail A : Purlin Spacing = 24" o.c. or less

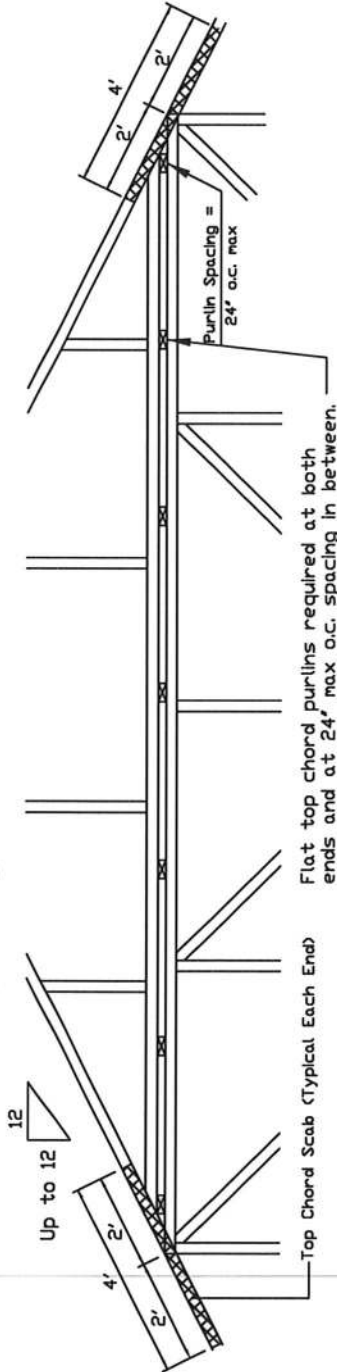

Flat top chord purlins required at both ends and at 24' max o.c. spacing in between.

Piggyback cap truss slant nailed to all top chord purlin bracing with (2) 16d box nails (0.135"x3.5") and secure top chord with 2x4 #3 grade scab (1 side only at each end) attached with 2 rows of 10d box nails (0.128"x3") at 4' o.c.

Attach purlin bracing to the flat top chord using (2) 16d box nails (0.135"x3.5").

The top chord #3 grade 2x4 scab may be replaced with either of the following: (1) 3X8 Trulox plate attached with (8) 0.120"x1.375" nails, (4) into cap TC & (4) into base truss TC or, (2) 28PB wave piggyback plate attached to the piggyback truss TC and attached to the base truss TC with (4) 0.120"x1.375" nails. Note: Nailing thru holes of wave plate is acceptable.

## Detail B : Purlin Spacing > 24" o.c.

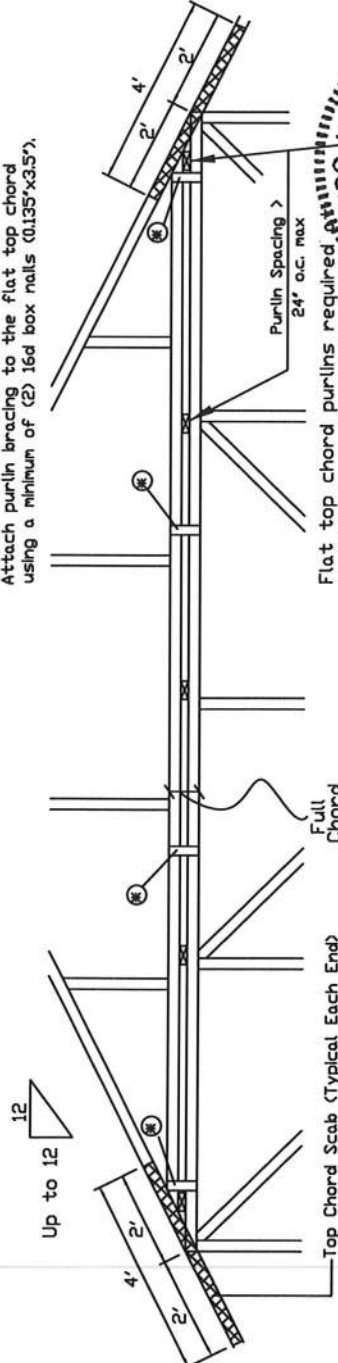

Note: If purlins or sheathing are not specified on the flat top of the base truss, purlins must be installed at 24' o.c. max. and use Detail A.

Piggyback cap truss slant nailed to all top chord purlin bracing with (2) 16d box nails (0.135"x3.5") and secure top chord with 2x4 #3 grade scab (1 side only at each end) attached with 2 rows of 10d box nails (0.128"x3") at 4' o.c. Attach purlin bracing to the flat top chord using a minimum of (2) 16d box nails (0.135"x3.5").

In addition, provide connection with one of the following methods:

**Trulox**  
 Use 3X8 Trulox plates for 2x4 chord member, and 3X10 Trulox plates for 2x6 and larger chord members. Attach to each face @ 8' o.c. with (4) 0.120"x1.375" nails into cap bottom chord and (4) in base truss top chord. Trulox plates may be staggered 4' o.c. front to back faces.

**APA Rated Gusset**

8"x8"x7/16" (min) APA rated sheathing gussets (each face). Attach @ 8' o.c. with (8) 8d common nails @ 2" o.c. in cap bottom chord and (4) in base truss top chord. Gussets may be staggered 4' o.c. front to back faces.

**2x4 Vertical Scabs**

2x4 SPF #2, Full chord depth scabs (each face). Attach @ 8' o.c. with (6) 10d box nails (0.128"x3") per scab, (3) in cap bottom chord and (3) in base truss top chord. Scabs may be staggered 4' o.c. front to back faces.

**28PB Wave Piggyback Plate**

Use 28PB wave piggyback plate to each face @ 8' o.c. Attach teeth to piggyback at top of scab. Attach teeth to supporting truss with (4) 0.120"x1.375" nails per face per ply. o.c. front piggyback plates may be staggered 4' o.c. front to back faces.

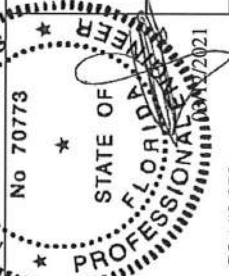

**IMPORTANT: READ AND FOLLOW ALL NOTES ON THIS DRAWING**  
 Trusses require extreme care in fabricating, handling, shipping, installing and bracing. Refer to and follow the latest edition of ICCI Building Component Safety Information, by TPI and SBCA for safety practices prior to performing these functions. Installers shall provide temporary bracing per ICCI. A seal on this drawing or cover page listing this drawing, indicates acceptance of professional engineering responsibility solely for the design shown. The suitability and use of this drawing for any structure is the responsibility of the Building Designer per ANSI/TPI 1 Sec.2.  
 For more information, see this job's general notes page and these web sites:  
 ALPINE: www.alpineinc.com TPI: www.tpinet.org SBCA: www.sbcaindustry.org ICC: www.iccsa.org

**ALPINE**  
 AN ITW COMPANY  
 113723 Riverport Drive  
 Suite 200  
 Maryland Heights, MO 63043

REF	PIGGYBACK
DATE	01/02/2018
DRWG	PB160160118

SPACING 24.0'

COA#0-278

# Piggyback Detail - ASCE 7-16: 180 mph, 30' Mean Hgt, Partially Enclosed, Exp. C, Kzt=1.00

180 mph Wind, 30.00 ft Mean Hgt, ASCE 7-16, Part. Enclosed Bldg. located anywhere in roof, Exp C, Wind DL= 5.0 psf (min), Kzt=1.0.  
 Dr 160 mph wind, 30.00 ft Mean Hgt, ASCE 7-16, Part. Enclosed Bldg. located anywhere in roof, Exp D, wind DL= 5.0 psf (min), Kzt=1.0.  
 Note: Top chords of trusses supporting piggyback cap trusses must be adequately braced by sheathing or purlins. The building Engineer of Record shall provide diagonal bracing or any other suitable anchorage to permanently restrain purlins, and lateral bracing for out of plane loads over gable ends.  
 Maximum truss spacing is 24' o.c. detail is not applicable if cap supports additional loads such as cupola, steeple, chimney or drag strut loads.  
 Refer to Engineer's sealed truss design drawing for piggyback and base truss specifications.

Piggyback cap truss slant nailed to all top chord purlin bracing with (2) 16d box nails (0.135"x3.5") and secure top chord with 2x4 #3 grade scab (1 side only at each end) attached with 2 rows of 10d box nails (0.128"x3") at 4' o.c.

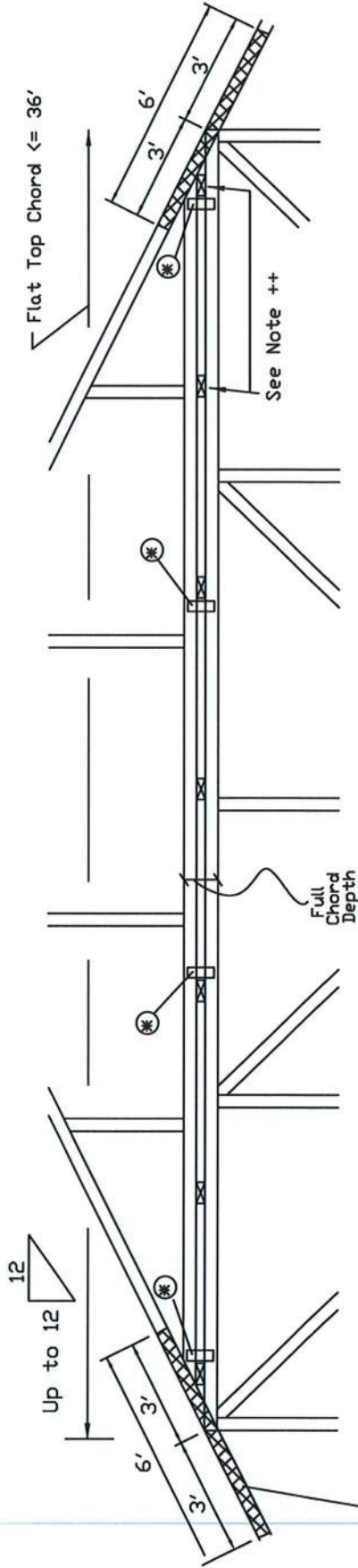

Top Chord Scab (Typical Each End)

<p><b>Trulox</b>                  Use 3x8 Trulox plates for 2x4 chord member, and 3x10 Trulox plates for 2x6 and larger chord members. Attach to each face @ 8' o.c. with (4) 0.120"x1.375" nails into cap bottom chord and (4) in base truss top chord. Trulox plates may be staggered 4' o.c. front to back faces.</p> <p><b>APA Rated Gusset</b>                  8"x8"x7/16" (min) APA rated sheathing gussets (each face). Attach @ 8' o.c. with (8) 6d common (0.113"x2") nails per gusset. (4) in cap bottom chord and (4) in base truss top chord. Gussets may be staggered 4' o.c. front to back faces.</p>	<p><b>28PB Wave Piggyback Plate</b>                  One 28PB wave piggyback plate to each face @ 8' o.c. Attach teeth to piggyback at time of fabrication. Attach to supporting truss with (4) 0.120"x1.375" nails per face per ply. Piggyback plates may be staggered 4' o.c. front to back faces.</p> <p><b>2x4 Vertical Scabs</b>                  2x4 SPF #2, full chord depth scabs (each face). Attach @ 8' o.c. with (6) 10d box nails (0.128"x3") per scab. (3) in cap bottom chord and (3) in base truss top chord. Scabs may be staggered 4' o.c. front to back faces.</p>
--	---

In addition, provide connection with one of the following methods:

REF	PIGGYBACK
DATE	01/02/2018
DRWG	PB180160118

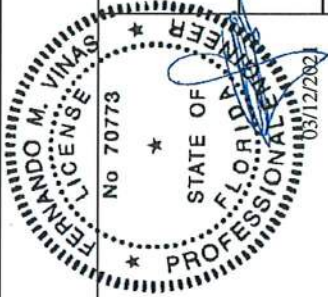

**WARNING: READ AND FOLLOW ALL NOTES ON THIS DRAWING AND FURNISH THIS DRAWING TO ALL CONTRACTORS INCLUDING THE INSTALLERS.**  
 Trusses require extreme care in fabricating, handling, shipping, installing and bracing. Refer to and follow the latest edition of BCSI Building Component Safety Information, by ITI and SBCA for safety practices prior to performing these functions. Installers shall provide temporary bracing per BCSI. Sheathing, top chord, shall have properly attached structural sheathing and bottom chord shall have bracing installed per BCSI sections B3, B7 or B10, as applicable. Apply plates to each face of truss and position as shown above and on the Joint Details, unless noted otherwise.  
 Alpine, a division of ITV Building Components Group Inc. shall not be responsible for any deviation from this drawing, any failure to build the truss in conformance with ANSI/TPI 1, or for handling, shipping, installing, or bracing of trusses.  
 A seal on this drawing certifies that the design was prepared by a professional engineer. The engineering responsibility and liability for the design shown. The suitability and use of this drawing for any structure is the responsibility of the Building Designer per ANSI/TPI 1 Sec.2.  
 For more information see this Job's general notes page and these web sites  
 ALPINE: www.alpineinc.com TPI: www.tpiinc.org SBCA: www.sbcaindustry.org ICC: www.iccsafe.org

**ALPINE**  
 AN ITV COMPANY  
 115141 Earth City Expressway  
 11 Suite 242  
 11 Earth City, MO, 63045

SPACING 24.0'

COA#0-278

# Cracked or Broken Member Repair Detail

Load Duration = 0%  
Member forces may be increased for Duration of Load

This drawing specifies repairs for a truss with broken chord or web member.

This design is valid only for single ply trusses with 2x4 or 2x6 broken members. No more than one break per chord panel and no more than two breaks per truss are allowed. Contact the truss manufacturer for any repairs that do not comply with this detail.

(B) = Damaged area, 12' max length of damaged section  
(L) = Minimum nailing distance on each side of damaged area (B)  
(S) = Two 2x4 or two 2x6 side members, same size, grade, and species as damaged member. Apply one scab per face. Minimum side member length(s) =  $(2)(L) + (B)$

Scab member length (S) must be within the broken panel.  
Nail into 2x4 members using two (2) rows at 4' o.c., rows staggered.  
Nail into 2x6 members using three (3) rows at 4' o.c., rows staggered.  
Nail using 10d box or gun nails (0.128"x3", min) into each side member.

The maximum permitted lumber grade for use with this detail is limited to Visual grade #1 and MSR grade 1650F.

This repair detail may be used for broken connector plate at mid-panel splices.

This repair detail may not be used for damaged chord or web sections occurring within the connector plate area.

Broken chord may not support any tie-in loads.

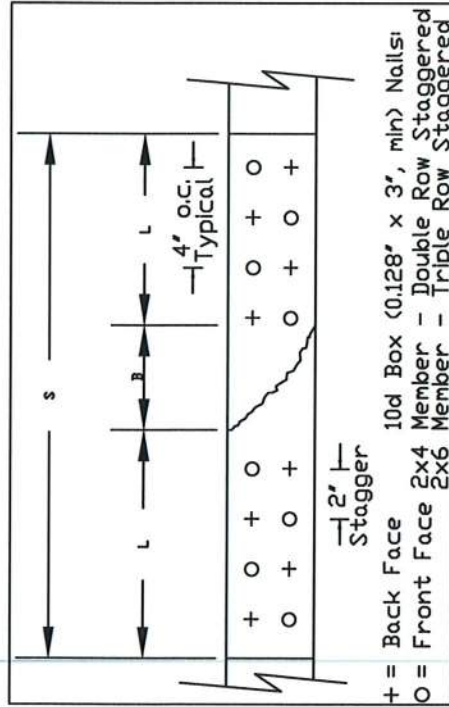

Nail Spacing Detail

Member	Size	L	Maximum Member Axial Force				
			SPF-C	HF	DF-L	SYP	
Web Only	2x4	12'	620#	635#	730#	800#	
Web Only	2x4	18'	975#	1055#	1295#	1415#	
Web or Chord	2x4	24'	975#	1055#	1495#	1745#	
Web or Chord	2x6		1465#	1585#	2245#	2620#	
Web or Chord	2x4	30'	1910#	1960#	2315#	2555#	
Web or Chord	2x6		2230#	2365#	3125#	3575#	
Web or Chord	2x4	36'	2470#	2530#	2930#	3210#	
Web or Chord	2x6		3535#	3635#	4295#	4745#	
Web or Chord	2x4	42'	2975#	3045#	3505#	3835#	
Web or Chord	2x6		4395#	4500#	5225#	5725#	
Web or Chord	2x4	48'	3460#	3540#	4070#	4445#	
Web or Chord	2x6		5165#	5280#	6095#	6660#	

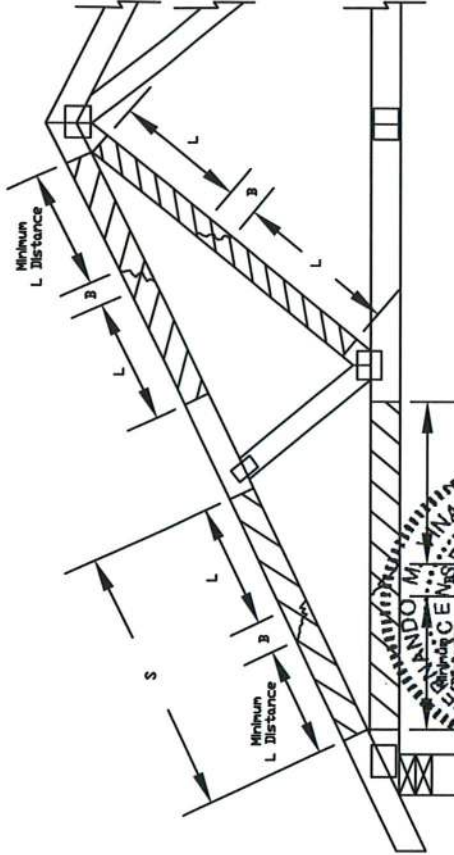

**WARNING: READ AND FOLLOW ALL NOTES ON THIS DRAWING INCLUDING THE INSTALLER.**  
**IMPORTANT: FURNISH THIS DRAWING TO ALL CONTRACTORS INCLUDING THE INSTALLERS.**  
 Trusses require extreme care in fabricating, handling, shipping, installing and bracing. Refer to and follow the latest edition of BCSI Building Component Safety Information, by TPI and SBCA for safety practices prior to performing these functions. Installers shall provide temporary bracing per BCSI. Unless noted otherwise, top chord shall have properly attached structural sheathing and bottom chord shall have bracing installed per BCSI sections 37 or 38 as applicable. All members shall be laterally braced to each face of truss and positioned as shown above and on the Joint Details, unless noted otherwise.  
 Refer to drawings 160A-Z for standard plate positions.  
 Alpha, a division of ITW Building Components Group Inc shall not be responsible for any deviation from this drawing, any failure to build the truss in conformance with ANSI/TPI 1, or for handling, shipping, installation, bracing of trusses.  
 The manufacturer shall not be responsible for the safety of the design shown. The liability and use of this drawing for any structure is the responsibility of the building designer per ANSI/TPI 1 Sec.2.  
 For more information see this job's general notes page and these web sites:  
 ALPINE: www.alphatru.com TPI: www.tpinet.org SBCA: www.sbcachain.org ICD: www.icdcsafe.org

REF MEMBER REPAIR  
 DATE 10/01/14  
 DRWG REPCHRD1014

SPACING 24.0' MAX

NO 70773  
 STATE OF FLORIDA  
 PROFESSIONAL ENGINEER  
 R. ANDREW M. MIVAS  
 03/12/2011

ALPINE  
 AN ITW COMPANY  
 115141 Earth City Expressway  
 11 Suite 242  
 11 Earth City, MO 63045

ALL WALLS SHOWN TO BE BEARING  
 AMERICA'S HOME PLACE, INC.  
 DANIELLO RESIDENCE ~ JILLIAN-A

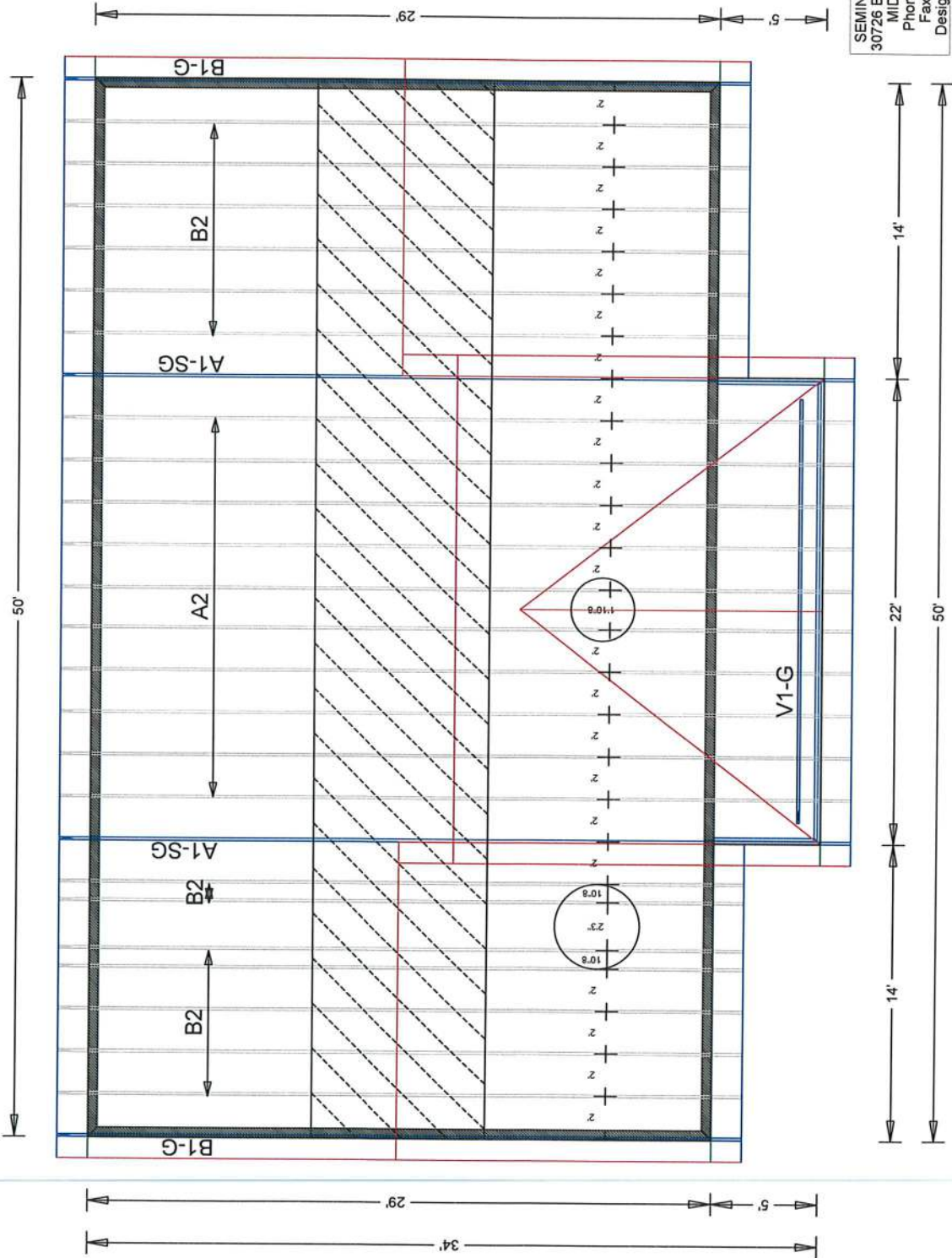

SEMINOLE TRUSSES INC.  
 30726 Bluestar Memorial Hwy.  
 MIDWAY, FL 32343  
 Phone (850) 575-0102  
 Fax (850) 575-4413  
 Design By Robert J. Little

Job Name: DANIELLO RESIDENCE  
 Customer: America's Home Place  
 Designer: ROBERT J. LITTLE  
 PlanName: JILLIAN-A  
 Created : 03-15-2021  
 SemRef# : B53089a

JOB NO:  
 B53089a

PAGE NO:  
 1 OF 1