

**INNOVATIVE**  
*Rose Pointe*  
 LAKE CITY  
 MODEL 1302  
 120 MPH ASCE WIND LOAD

**Roof Loading**  
 TC Live: 20.00 psf  
 TC Dead: 10.00 psf  
 BC Live: 0.00 psf  
 BC Dead: 10.00 psf  
 TC Stress Inc: 25.00  
 BC Stress Inc: 25.00  
 Spacing: 2-0-0 o.c.

**Account: CONTRACTORS**  
 Job: INN-CG-1302  
 Designer: C. LITTLE  
 Checker:  
 Date: 04-25-14

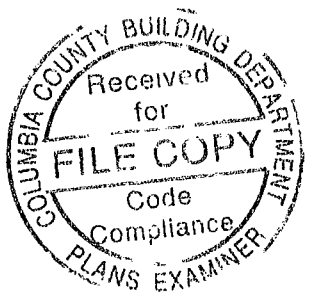

#31974



Lumber design values are in accordance with ANSI/TPI 1 section 6.3  
 These truss designs rely on lumber values established by others.

RE: INN-CG-1302 -

**MITek USA, Inc.**

6904 Parke East Blvd.  
 Tampa, FL 33610-4115

**Site Information:**

Customer Info: INNOVATIVE Project Name: ~~COTTAGE GROVE~~ MODEL 1302 Model:  
 Lot/Block: Subdivision: *Rose Pointe*  
 Address: 1302 MODEL  
 City: LAKE CITY State: FLORIDA

**Name Address and License # of Structural Engineer of Record, If there is one, for the building.**

Name: License #:  
 Address:  
 City: State:

**General Truss Engineering Criteria & Design Loads (Individual Truss Design Drawings Show Special Loading Conditions):**

Design Code: FBC2010 Design Program: OnLine Plus 30.0.023  
 Wind Code: ASCE 7-10 Wind Speed: 120 mph  
 Roof Load: 40.0 psf Floor Load: N/A psf

This package includes 21 individual, dated Truss Design Drawings and 0 Additional Drawings.  
 With my seal affixed to this sheet, I hereby certify that I am the Truss Design Engineer and this index sheet conforms to 61G15-31.003, section 5 of the Florida Board of Professional Engineers Rules.

No.	Seal#	Truss Name	Date	No.	Seal#	Truss Name	Date
1	T6277961	A1	4/25/014	18	T6277978	J1A	4/25/014
2	T6277962	A2	4/25/014	19	T6277979	J2	4/25/014
3	T6277963	A3	4/25/014	20	T6277980	J3	4/25/014
4	T6277964	A4GE	4/25/014	21	T6277981	J4	4/25/014
5	T6277965	A5	4/25/014				
6	T6277966	A6	4/25/014				
7	T6277967	A7	4/25/014				
8	T6277968	A8	4/25/014				
9	T6277969	A9	4/25/014				
10	T6277970	A10	4/25/014				
11	T6277971	A11GIR	4/25/014				
12	T6277972	B1	4/25/014				
13	T6277973	B2	4/25/014				
14	T6277974	B3GE	4/25/014				
15	T6277975	CJ1	4/25/014				
16	T6277976	CJ2	4/25/014				
17	T6277977	J1	4/25/014				

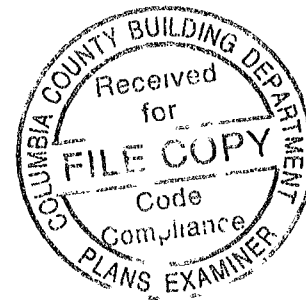

The truss drawing(s) referenced above have been prepared by MiTek Industries, Inc. under my direct supervision based on the parameters provided by Mayo Truss Company, Inc..

Truss Design Engineer's Name: Albani, Thomas  
 My license renewal date for the state of Florida is February 28, 2015.

**IMPORTANT NOTE:** Truss Engineer's responsibility is solely for design of individual trusses based upon design parameters shown on referenced truss drawings. Parameters have not been verified as appropriate for any use. Any location identification specified is for file reference only and has not been used in preparing design. Suitability of truss designs for any particular building is the responsibility of the building designer, not the Truss Engineer, per ANSI/TPI-1, Chapter 2.

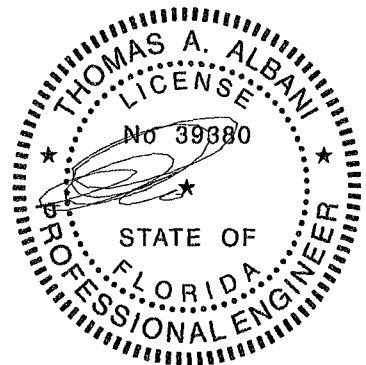

FL Cert. 6634

April 25, 2014

Job <b>INN-CG-1302</b>	Mark <b>AI</b>	Quan 9	Type TR	Span 360000	P1-H1 8	Left OH 1- 6- 0	Right OH 1- 6- 0	Engineering <b>T6277961</b>
---------------------------	-------------------	-----------	------------	----------------	------------	--------------------	---------------------	--------------------------------

COTTAGE GROVE MODEL 1302

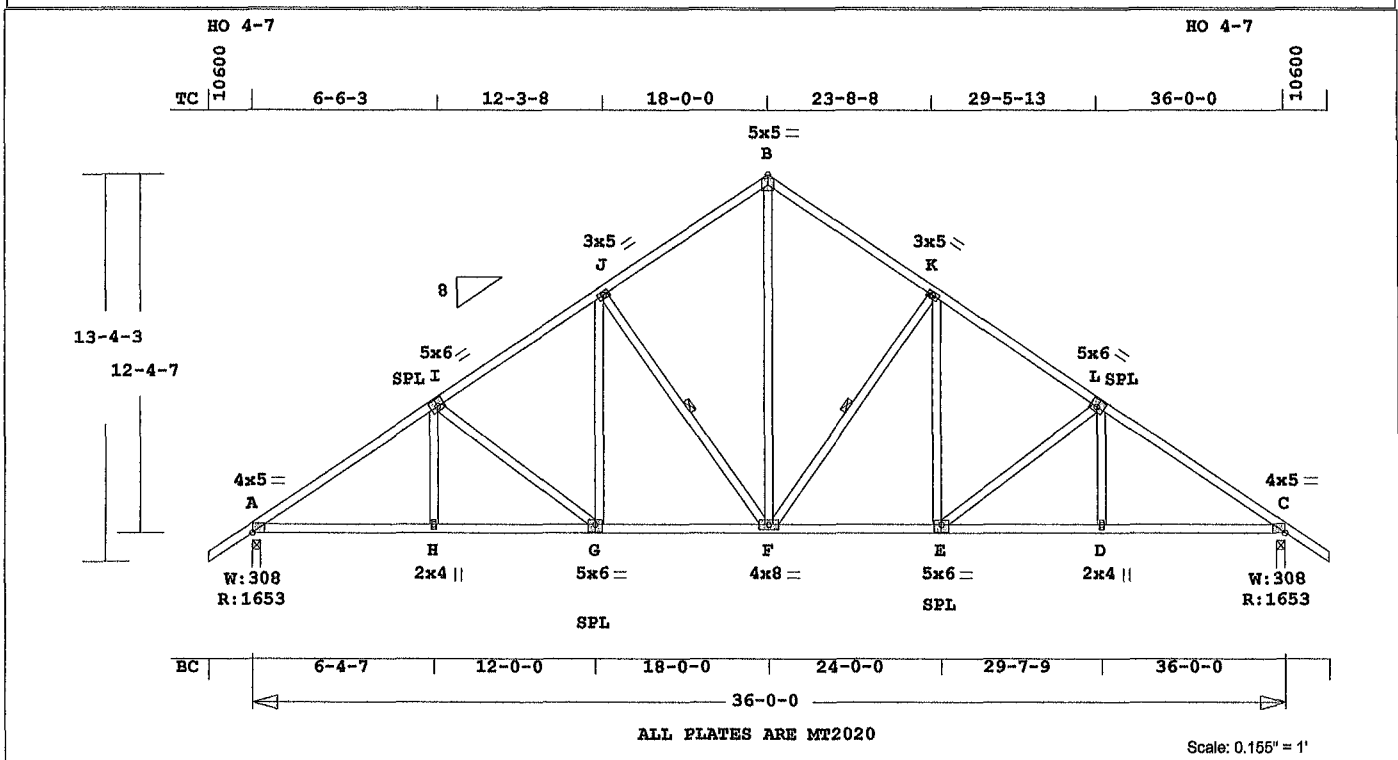

Online Plus -- Version 30.0.023  
RUN DATE: 25-APR-14

Southern Pine lumber design values are those effective 06-01-13 by SPIB//ALSC UON CSI -Size- Lumber-  
TC 0 38 2x 4 SP-#2  
BC 0 56 2x 4 SP-#2  
WB 0 49 2x 4 SP-#2

Brace truss as follows:  
O.C. From To  
TC Cont. 0- 0- 0 36- 0- 0  
or 42.0" 0- 0- 0 36- 0- 0  
BC Cont. 0- 0- 0 36- 0- 0  
or 120.0" 0- 0- 0 36- 0- 0

Continuous Lateral Restraint req'd at mid-point of webs:  
J -F F -K  
Attach CLR with (2)-10d nails at each web  
Refer to BCSI for diagonal restraint requirements.

psf-Ld	Dead	Live		
TC	10.0	20.0		
BC	10.0	0.0		
TC+BC	20.0	20.0		
Total	40.0	Spacing 24.0"		
Lumber	Duration Factor	1.25		
Plate	Duration Factor	1.25		
	Fb	Fc	Ft	Emin
TC	1.15	1.10	1.10	1.10
BC	1.10	1.10	1.10	1.10

Total Load Reactions (Lbs)  
Jt Down Uplift Horiz-  
A 1653 198 R  
C 1653 198 R

Jt	Brg Size	Required
A	3.5"	2.0"
C	3.5"	2.0"

Plus 21 Wind Load Case(s)  
Plus 1 UBC LL Load Case(s)  
Plus 1 BC LL Load Case(s)  
Plus 1 DL Load Case(s)

Membr	CSI	P Lbs	Ax1-CSI-Bnd
Top Chords			
A -I	0.38	2307 C	0.05 0.33
I -J	0.34	1921 C	0.02 0.32
J -B	0.33	1460 C	0.01 0.32
B -K	0.33	1460 C	0.01 0.32
K -L	0.34	1921 C	0.02 0.32
L -C	0.38	2307 C	0.05 0.33

MiTek® Online Plus™ APPROX TRUSS WEIGHT: 287.1 LBS

Bottom Chords				
A -H	0.52	1918 T	0.39	0.13
H -G	0.56	1918 T	0.39	0.17
G -F	0.56	1599 T	0.32	0.24
F -E	0.56	1599 T	0.32	0.24
E -D	0.56	1918 T	0.39	0.17
D -C	0.52	1918 T	0.39	0.13

Webs				
H -I	0.04	235 T		
I -G	0.36	411 C		
G -J	0.10	444 T		
J -F	0.30	665 C	1 Br	
F -B	0.49	1272 T		
F -K	0.30	665 C	1 Br	
E -K	0.10	444 T		
E -L	0.36	411 C		
D -L	0.04	235 T		

TL Defl -0.30" in F -E L/999  
LL Defl -0.14" in F -E L/999  
Shear // Grain in A -I 0.19

Plates for each ply each face.  
Plate - MT20 20 Ga, Gross Area  
Plate - MT2H 20 Ga, Gross Area  
Jt Type Plt Size X Y JSI

A	MT20	4.0x 5.0	Ctr	0.1	0.76
I	MT20	5.0x 6.0-0.3	0.5	0.67	
J	MT20	3.0x 5.0	Ctr	Ctr	0.37
B	MT20	5.0x 5.0	Ctr	Ctr	0.53
K	MT20	3.0x 5.0	Ctr	Ctr	0.37
L	MT20	5.0x 6.0	0.3	0.5	0.67
C	MT20	4.0x 5.0	Ctr	0.1	0.76
H	MT20	2.0x 4.0	Ctr	Ctr	0.34
G	MT20	5.0x 6.0	Ctr-0.5	0.72	
F	MT20	4.0x 8.0	Ctr	Ctr	0.48
E	MT20	5.0x 6.0	Ctr-0.5	0.72	
D	MT20	2.0x 4.0	Ctr	Ctr	0.34

REVIEWED BY:  
MiTek Industries, Inc.  
6904 Parke East Blvd.  
Tampa, FL 33610

REFER TO ONLINE PLUS GENERAL NOTES AND SYMBOLS SHEET FOR ADDITIONAL SPECIFICATIONS.

NOTES:  
Trusses Manufactured by:  
Mayo Truss Co. Inc.  
Analysis Conforms To:  
FBC2010  
TPI 2007

OH Loading  
Soffit psf 2.0  
This truss has been designed for 20.0 psf LL on the B.C.

in areas where a rectangle 3- 6- 0 tall by 2- 0- 0 wide will fit between the B.C. and any other member. Design checked for 10 psf non-concurrent LL on BC.

Wind Loads - ANSI / ASCE 7-10  
Truss is designed as Components and Claddings\* for Exterior zone location. Wind Speed: 120 mph  
Risk Category : II  
Mean Roof Height: 15-0  
Exposure Category: B  
Building Type: Enclosed  
TC Dead Load: 6.0 psf  
BC Dead Load: 6.0 psf  
Max comp. force 2307 Lbs  
Max tens. force 1918 Lbs  
Connector Plate Fabrication Tolerance = 20%  
This truss is designed for a creep factor of 1.5 which is used to calculate total load deflection.

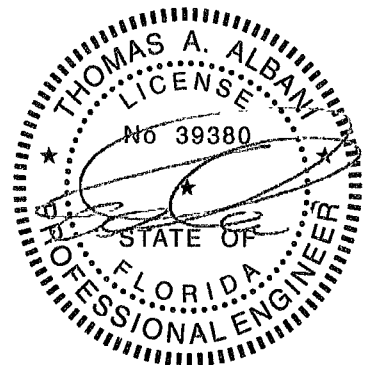

FL Cert. 6634

April 25, 2014

Job <b>INN-CG-1302</b>	Mark <b>A2</b>	Quan <b>1</b>	Type <b>TR</b>	Span <b>360000</b>	Pl-H1 <b>8</b>	Left OH <b>1- 6- 0</b>	Right OH <b>1- 6- 0</b>	Engineering <b>T6277962</b>
---------------------------	-------------------	------------------	-------------------	-----------------------	-------------------	---------------------------	----------------------------	--------------------------------

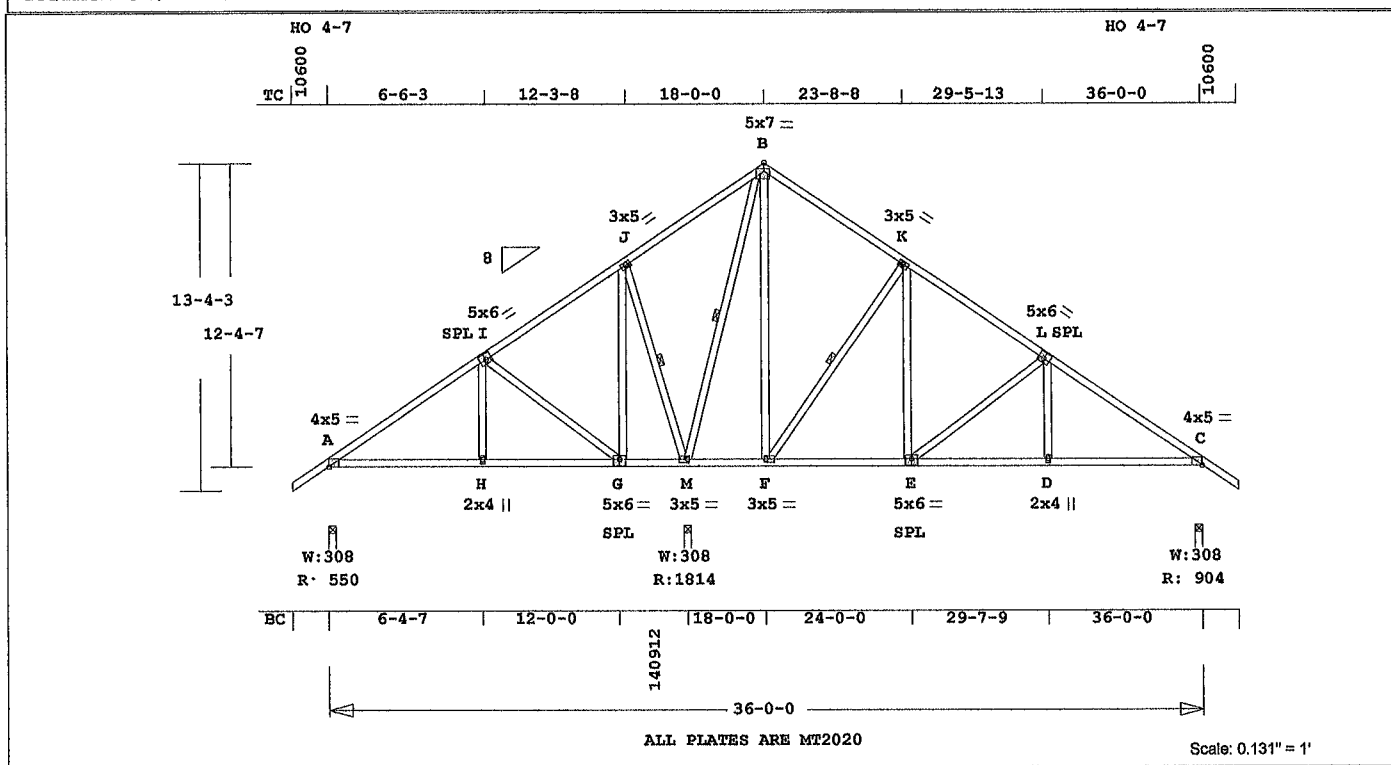

Online Plus -- Version 30 0 023  
 RUN DATE: 25-APR-14

Southern Pine Lumber design values are those effective 06-01-13 by SPIB//ALSC UON

CSI	Size	Lumber
TC	0 38 2x 4	SP-#2
BC	0 36 2x 4	SP-#2
WB	0 82 2x 4	SP-#2

Brace truss as follows:

O C.	From	To
TC Cont.	0-0-0	36-0-0
or	48.0"	0-0-0 36-0-0
BC Cont.	0-0-0	36-0-0
or	72.0"	0-0-0 36-0-0

Continuous Lateral Restraint req'd at mid-point of webs:  
 J-M M-B F-K

Attach CLR with (2)-10d nails at each web  
 Refer to BCSI for diagonal restraint requirements

psf-Ld	Dead	Live
TC	10 0	20 0
BC	10 0	0 0
TC+BC	20 0	20 0
Total	40 0	24 0"
Lumber	Duration	Factor
Plate	Duration	Factor
	Fb	Fc Ft Emin
TC	1 15	1.10 1 10 1.10
BC	1 10	1.10 1 10 1 10

Total Load Reactions (Lbs)

Jt	Down	Uplift	Horiz-
A	551		197 R
M	1814		
C	905		197 R

Jt	Brg Size	Required
A	3.5"	1.5"
M	3.5"	1.9"
C	3.5"	1.5"

Plus 21 Wind Load Case(s)  
 Plus 1 UBC LL Load Case(s)  
 Plus 1 BC LL Load Case(s)  
 Plus 1 DL Load Case(s)

Membr CSI P Lbs Axl-CSI-Bnd

Top Chords				
A -I	0.38	404 C	0.00	0.38
I -J	0.37	79 T	0.02	0.35
J -B	0.38	251 T	0.03	0.35
B -K	0.32	180 C	0.00	0.32
K -L	0.35	600 C	0.00	0.35
L -C	0.36	1011 C	0.00	0.36

MiTek® Online Plus™ APPROX. TRUSS WEIGHT. 307.3 LBS

-----Bottom Chords-----

A -H	0.29	422 T	0.07	0.22
H -G	0.28	422 T	0.04	0.24
G -M	0.11	140 C	0.00	0.11
M -F	0.15	199 T	0.01	0.14
F -E	0.34	546 T	0.10	0.24
E -D	0.36	902 T	0.17	0.19
D -C	0.35	902 T	0.17	0.18

-----Webs-----

H -I	0.05	271 T		
I -G	0.42	475 C		
G -J	0.07	373 T		
J -M	0.21	609 C	1 Br	
M -B	0.82	1180 C	1 Br	
F -B	0.17	734 T		
F -K	0.31	686 C	1 Br	
E -K	0.10	471 T		
E -L	0.39	444 C		
D -L	0.04	249 T		

TL Defl -0 12" in F -E L/999  
 LL Defl -0 06" in F -E L/999  
 Shear // Grain in A -I 0 21

Plates for each ply each face.  
 Plate - MT20 20 Ga, Gross Area  
 Plate - MT2H 20 Ga, Gross Area

Jt Type	Plt Size	X	Y	JSI
A	MT20	4 0x 5.0	Ctr	0.1 0.37
I	MT20	5.0x 6.0	-0.3 0.5	0.69
J	MT20	3.0x 5.0	Ctr	0.37
B	MT20	5.0x 7.0	-0.5-1 0	0.65
K	MT20	3.0x 5.0	Ctr	0.37
L	MT20	5.0x 6.0	0.3 0.5	0.66
C	MT20	4.0x 5.0	Ctr	0 1 0.37
H	MT20	2 0x 4 0	Ctr	0.34
G	MT20	5.0x 6.0	Ctr	-0.5 0 0.39
M	MT20	3.0x 5.0	Ctr	0.46
F	MT20	3 0x 5.0	Ctr	0 0.52
E	MT20	5.0x 6.0	Ctr	-0.5 0.51
D	MT20	2.0x 4.0	Ctr	0.34

REVIEWED BY:  
 MiTek Industries, Inc  
 6904 Parke East Blvd.  
 Tampa, FL 33610

REFER TO ONLINE PLUS GENERAL NOTES AND SYMBOLS SHEET FOR ADDITIONAL SPECIFICATIONS.

NOTES:  
 Trusses Manufactured by: Mayo Truss Co. Inc.  
 Analysis Conforms To: FBC2010  
 TPI 2007  
 OH Loading  
 Soffit psf 2 0  
 This truss has been designed

for 20.0 psf LL on the B.C in areas where a rectangle 3- 6- 0 tall by 2- 0- 0 wide will fit between the B.C and any other member  
 Design checked for 10 psf non-concurrent LL on BC  
 Wind Loads - ANSI / ASCE 7-10  
 Truss is designed as Components and Claddings\* for Exterior zone location  
 Wind Speed 120 mph  
 Risk Category : II  
 Mean Roof Height 15-0  
 Exposure Category B  
 Building Type Enclosed  
 TC Dead Load 6.0 psf  
 BC Dead Load 6 0 psf  
 Max comp force 1180 Lbs  
 Max tens force 902 Lbs  
 Connector Plate Fabrication Tolerance = 20%  
 This truss is designed for a creep factor of 1.5 which is used to calculate total load deflection.

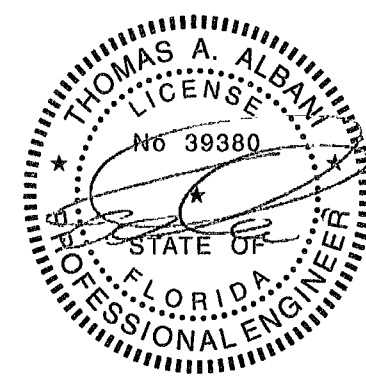

FL Cert. 6634

April 25, 2014

Job <b>INN-CG-1302</b>	Mark <b>A3</b>	Quan <b>1</b>	Type <b>SP</b>	Span <b>360000</b>	P1-H1 <b>8</b>	Left OH <b>1- 6- 0</b>	Right OH <b>1- 6- 0</b>	Engineering <b>T6277963</b>
---------------------------	-------------------	------------------	-------------------	-----------------------	-------------------	---------------------------	----------------------------	--------------------------------

**COTTAGE GROVE MODEL 1302**

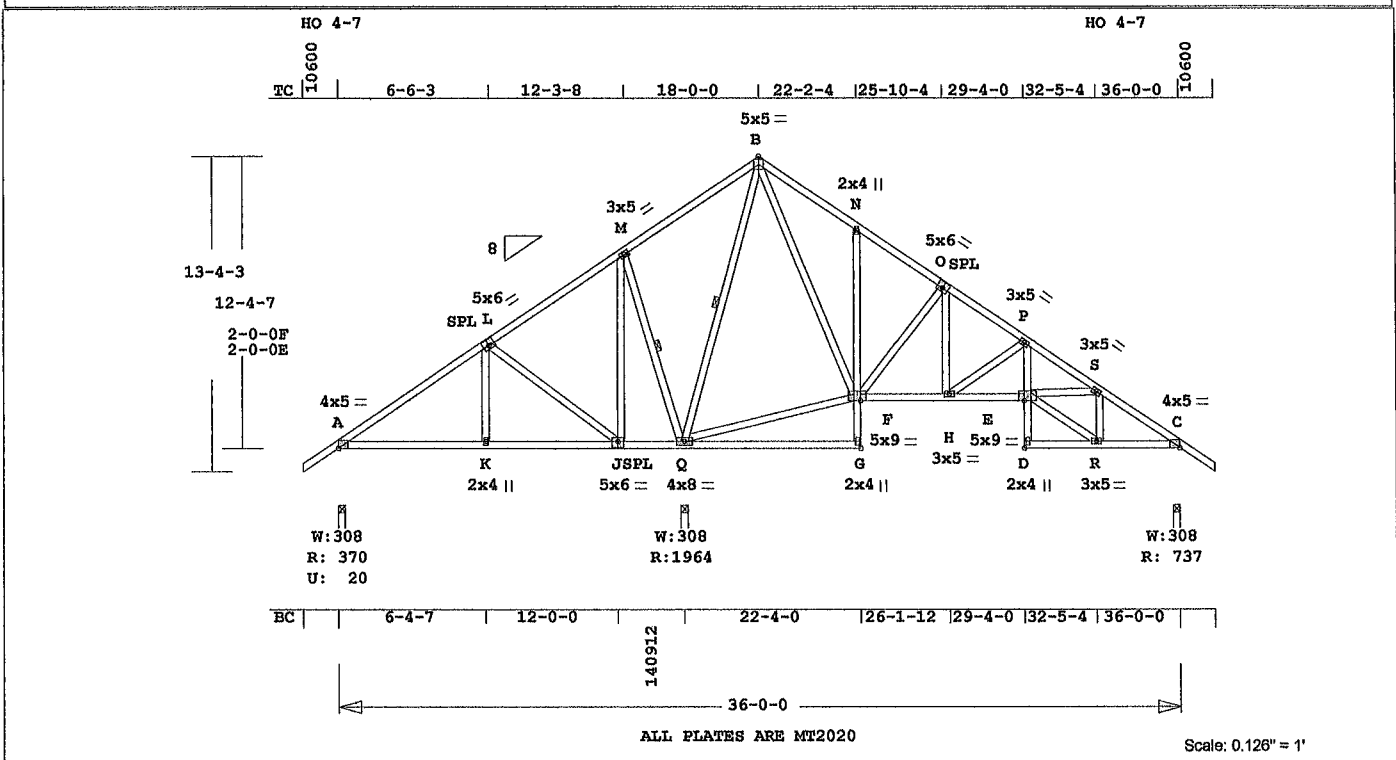

ALL PLATES ARE MT2020

Scale: 0.126" = 1'

Online Plus -- Version 30.0.023  
RUN DATE: 25-APR-14

Southern Pine Lumber design values are those effective 06-01-13 by SPIB//ALSC UON  
CSI -Size- ---Lumber---  
TC 0.52 2x 4 SP-#2  
BC 0.41 2x 4 SP-#2  
CW 0.14 2x 4 SP-#2  
WB 0.98 2x 4 SP-#2

Brace truss as follows:  
O C From To  
TC Cont. 0-0-0 36-0-0  
or 48 0" 0-0-0 36-0-0  
BC Cont. 0-0-0 36-0-0  
or 72.0" 0-0-0 36-0-0

Continuous Lateral Restraint req'd at mid-point of webs  
M-Q Q-B  
Attach CLR with (2)-10d nails at each web  
Refer to ECSI for diagonal restraint requirements.

psf-Ld Dead Live  
TC 10.0 20.0  
BC 10.0 0 0  
TC+BC 20.0 20.0  
Total 40.0 Spacing 24.0"  
Lumber Duration Factor 1.25  
Plate Duration Factor 1.25  
Fb Fc Ft Emin  
TC 1.15 1.10 1.10 1.10  
BC 1.10 1.10 1.10 1.10

Total Load Reactions (lbs)  
Jt Down Uplift Horiz-  
A 370 20 U 198 R  
Q 1965  
C 737 198 R

Jt Brg Size Required  
A 3.5" 1.5"  
Q 3.5" 2.1"  
C 3.5" 1.5"

Plus 21 Wind Load Case(s)  
Plus 1 UBC LL Load Case(s)  
Plus 1 DL Load Case(s)

Membr CSI P Lbs Axl-CSI-End  
-----Top Chords-----  
A -L 0.39 92 T 0.00 0.39  
L -M 0.49 384 T 0.09 0.40  
M -B 0.52 551 T 0.09 0.43

MITek® Online Plus™ APPROX. TRUSS WEIGHT 332.7 LBS

B -N	0.35	272	C	0.00	0.35	E MT20	5.0x	9.0	Ctr	0.8	0.40
N -O	0.15	214	C	0.00	0.15	D MT20	2.0x	4.0	Ctr	0.58	
O -P	0.15	608	C	0.00	0.15	R MT20	3.0x	5.0	Ctr	0.49	
P -S	0.09	1194	C	0.01	0.08						
S -C	0.11	858	C	0.00	0.11						

-----Bottom Chords-----

A -K	0.27	222	T	0.01	0.26
K -J	0.26	222	T	0.00	0.26
J -Q	0.37	358	C	0.00	0.37
Q -G	0.41	5	T	0.00	0.41
F -H	0.15	584	T	0.10	0.05
H -E	0.26	1099	T	0.20	0.06
D -R	0.06	15	T	0.00	0.06
R -C	0.20	773	T	0.14	0.06

-----Chord-Webs-----

G -F	0.04	120	T	0.01	0.03
F -N	0.07	194	C	0.03	0.04
D -E	0.08	53	T	0.00	0.08
E -P	0.14	505	T	0.10	0.04

-----Webs-----

K -L	0.05	283	T		
L -J	0.42	480	C		
J -M	0.06	304	T		
M -Q	0.20	599	C	1 Br	
Q -B	0.88	1239	C	1 Br	
Q -F	0.30	297	C		
B -F	0.20	771	T		
F -O	0.35	574	C		
H -O	0.09	446	T		
H -P	0.18	625	C		
E -S	0.06	320	T		
E -R	0.18	901	T		
R -S	0.05	427	C		

TL Defl -0.25" in Q -G L/994  
LL Defl -0.11" in Q -G L/999  
Shear // Grain in M -B 0.22

Plates for each ply each face.  
Plate - MT20 20 Ga, Gross Area  
Plate - MT2H 20 Ga, Gross Area  
Jt Type Plt Size X Y JSI  
A MT20 4.0x 5.0 Ctr 0.1 0.37  
L MT20 5.0x 6.0-0.3 0.5 0.70  
M MT20 3.0x 5.0 Ctr Ctr 0.37  
B MT20 5.0x 5.0 Ctr Ctr 0.76  
N MT20 2.0x 4.0 Ctr Ctr 0.29  
O MT20 5.0x 6.0 0.3 0.5 0.46  
P MT20 3.0x 5.0 Ctr Ctr 0.45  
S MT20 3.0x 5.0 Ctr Ctr 0.37  
C MT20 4.0x 5.0 Ctr 0.1 0.37  
K MT20 2.0x 4.0 Ctr Ctr 0.34  
J MT20 5.0x 6.0 Ctr-0.5 0.39  
Q MT20 4.0x 8.0 Ctr Ctr 0.31  
G MT20 2.0x 4.0 Ctr Ctr 0.58  
F MT20 5.0x 9.0 Ctr 0.8 0.50  
H MT20 3.0x 5.0 Ctr Ctr 0.33

REVIEWED BY:  
MITek Industries, Inc  
6904 Parke East Blvd  
Tampa, FL 33610

REFER TO ONLINE PLUS GENERAL NOTES AND SYMBOLS SHEET FOR ADDITIONAL SPECIFICATIONS

NOTES  
Trusses Manufactured by Mayo Truss Co. Inc  
Analysis Conforms To FBC2010  
TPI 2007

OH Loading  
Soffit psf 2.0  
This truss has been designed for 20.0 psf LL on the BC in areas where a rectangle 3-6-0 tall by 2-0-0 wide will fit between the B.C and any other member.  
Design checked for 10 psf non-concurrent LL on BC.

Wind Loads - ANSI / ASCE 7-10  
Truss is designed as Components and Claddings\* for Exterior zone location.  
Wind Speed: 120 mph  
Risk Category : II  
Mean Roof Height: 15-0  
Exposure Category: B  
Building Type Enclosed  
TC Dead Load: 6.0 psf  
BC Dead Load: 6.0 psf  
Max comp. force 1239 Lbs  
Max tens. force 1099 Lbs  
Connector Plate Fabrication Tolerance = 20%  
This truss is designed for a creep factor of 1.5 which is used to calculate total load deflection.

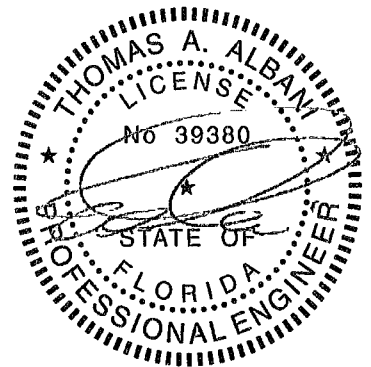

FL Cert. 6634

April 25, 2014

Job <b>INN-CG-1302</b>	Mark <b>A4GE</b>	Quan 1	Type TR	Span 360000	P1-H1 8	Left OH 1- 6- 0	Right OH 1- 6- 0	Engineering <b>T6277964</b>
---------------------------	---------------------	-----------	------------	----------------	------------	--------------------	---------------------	--------------------------------

**COTTAGE GROVE MODEL 1302**

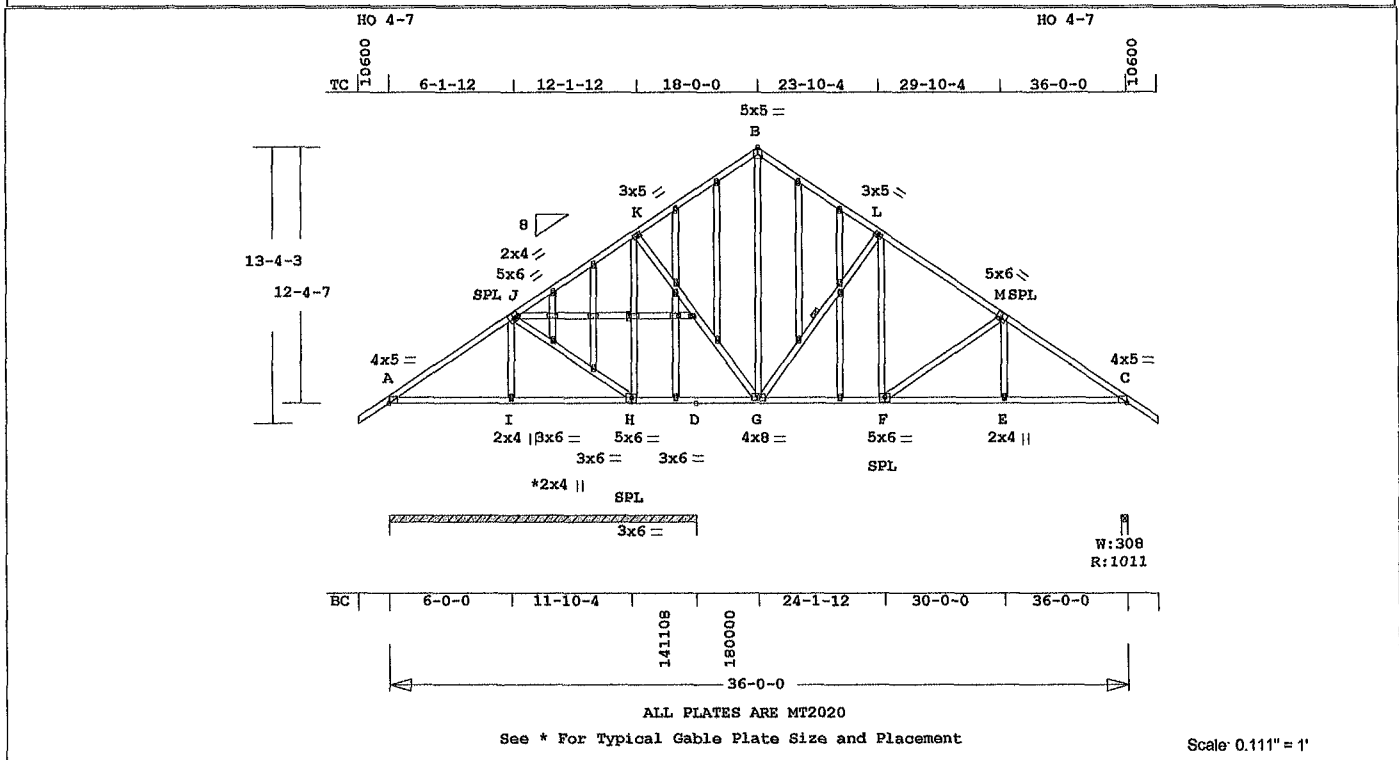

ALL PLATES ARE MT2020  
See \* For Typical Gable Plate Size and Placement

Scale: 0.111" = 1'

Online Plus -- Version 30.0.023  
RUN DATE: 25-APR-14

Southern Pine lumber design values are those effective 06-01-13 by SPIB//ALSC UON

CSI -Size-	Lumber----
TC 0.39	2x 4 SP-#2
BC 0.33	2x 4 SP-#2
WB 0.39	2x 4 SP-#2

Brace truss as follows:

O.C.	From	To
TC Cont.	0- 0- 0	36- 0- 0
or 48.0"	0- 0- 0	36- 0- 0
BC Cont.	0- 0- 0	36- 0- 0
or 72.0"	0- 0- 0	36- 0- 0

Continuous Lateral Restraint req'd at mid-point of webs:

H -K G -L  
Attach CLR with (2)-10d nails at each web.  
Refer to BCSI for diagonal restraint requirements.

psf-Ld	Dead	Live		
TC	10.0	20.0		
BC	10.0	0.0		
TC+BC	20.0	20.0		
Total	40.0	Spacing 24.0"		
Lumber	Duration Factor	1.25		
Plate	Duration Factor	1.25		
	Fb	Fc	Ft	Emin
TC	1.15	1.10	1.10	1.10
BC	1.10	1.10	1.10	1.10

Total Load Reactions (Lbs)

Jt	Down	Uplift	Horiz-
D	2061	198	R
C	1911	198	R

Jt	Brg Size	Required
D	179.5"	0"-to- 180"
C	3.5"	1.5"

Plus 21 Wind Load Case(s)  
Plus 1 UBC LL Load Case(s)  
Plus 1 DL Load Case(s)

Membr	CSI	P Lbs	Arl	CSI-Bnd
-----Top Chords-----				
A -J	0.37	160	C	0.00 0.37
J -K	0.39	135	T	0.04 0.35
K -B	0.35	392	C	0.00 0.35
B -L	0.36	392	C	0.00 0.36
L -M	0.36	794	C	0.00 0.36
M -C	0.33	1220	C	0.01 0.32
-----Bottom Chords-----				
A -I	0.24	83	T	0.00 0.24

MiTek® Online Plus™ APPROX TRUSS WEIGHT. 378.6 LBS

I -H	0.24	83	T	0.00	0.24
H -D	0.13	82	C	0.00	0.13
D -G	0.12	227	C	0.00	0.12
G -F	0.29	692	T	0.08	0.21
F -E	0.33	1056	T	0.12	0.21
E -C	0.32	1056	T	0.20	0.12

-----Webs-----					
I -J	0.01	96	T		
J -H	0.29	332	C		
H -K	0.36	1157	C	1 Br	
K -G	0.14	869	T		
G -B	0.21	172	T		
B -L	0.28	626	C	1 Br	
F -L	0.08	432	T		
F -M	0.39	439	C		
E -M	0.04	239	T		

TL Defl	-0.10"	in G -F	L/999
LL Defl	-0.04"	in G -F	L/999
Shear // Grain	in A -J	0.21	

Plates for each ply each face.					
Plate -	MT20	20	Ga,	Gross	Area
Plate -	MT2H	20	Ga,	Gross	Area
Jt Type	Plt Size	X	Y	JSI	
A	MT20	4.0x	5.0	Ctr	0.1 0.37
J	MT20	5.0x	6.0	0-0.3	0.5 0.71
K	MT20	3.0x	5.0	Ctr	Ctr 0.64
B	MT20	5.0x	5.0	Ctr	Ctr 0.45
L	MT20	3.0x	5.0	Ctr	Ctr 0.37
M	MT20	5.0x	6.0	0.3	0.5 0.61
C	MT20	4.0x	5.0	Ctr	0.1 0.41
I	MT20	2.0x	4.0	Ctr	Ctr 0.34
H	MT20	5.0x	6.0	Ctr	-0.5 0.39
G	MT20	4.0x	8.0	Ctr	Ctr 0.35
F	MT20	5.0x	6.0	Ctr	-0.5 0.57
E	MT20	2.0x	4.0	Ctr	Ctr 0.34

9 Gable studs to be attached with 2.0x4.0 plates each end.

REVIEWED BY:  
MiTek Industries, Inc.  
6904 Parke East Blvd.  
Tampa, FL 33610

REFER TO ONLINE PLUS GENERAL NOTES AND SYMBOLS SHEET FOR ADDITIONAL SPECIFICATIONS.

NOTES:  
Trusses Manufactured by:  
Mayo Truss Co. Inc.  
Analysis Conforms To:  
FBC2010  
TPI 2007  
OH Loading  
Soffit psf 2.0  
Design checked for 10 psf non-concurrent LL on BC.

Truss designed for wind loads in the plane of the truss only. For studs exposed to wind (normal to the face), see Standard Industry Gable End Details as applicable, or consult qualified Building Designer as per ANSI/TPI 1.

Wind Loads - ANSI / ASCE 7-10  
Truss is designed as Components and Claddings\* for Exterior zone location.  
Wind Speed: 120 mph  
Risk Category: II  
Mean Roof Height: 15-0  
Exposure Category: B  
Building Type: Enclosed  
TC Dead Load: 6.0 psf  
BC Dead Load: 6.0 psf  
Max comp. force: 1220 Lbs  
Max tens. force: 1056 Lbs  
Connector Plate Fabrication Tolerance = 20%  
This truss is designed for a creep factor of 1.5 which is used to calculate total load deflection.

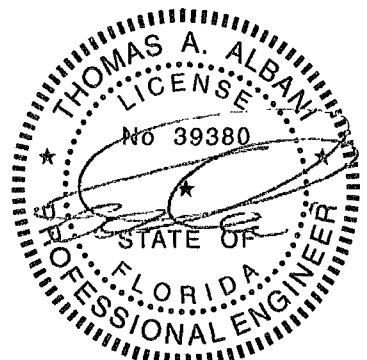

FL Cert. 6634

April 25, 2014

Job <b>INN-CG-1302</b>	Mark <b>A5</b>	Quan 1	Type HIPP	Span 360000	Pl-H1 8	Left OH 1- 6- 0	Right OH 1- 6- 0	Engineering <b>T6277965</b>
---------------------------	-------------------	-----------	--------------	----------------	------------	--------------------	---------------------	--------------------------------

COTTAGE GROVE MODEL 1302

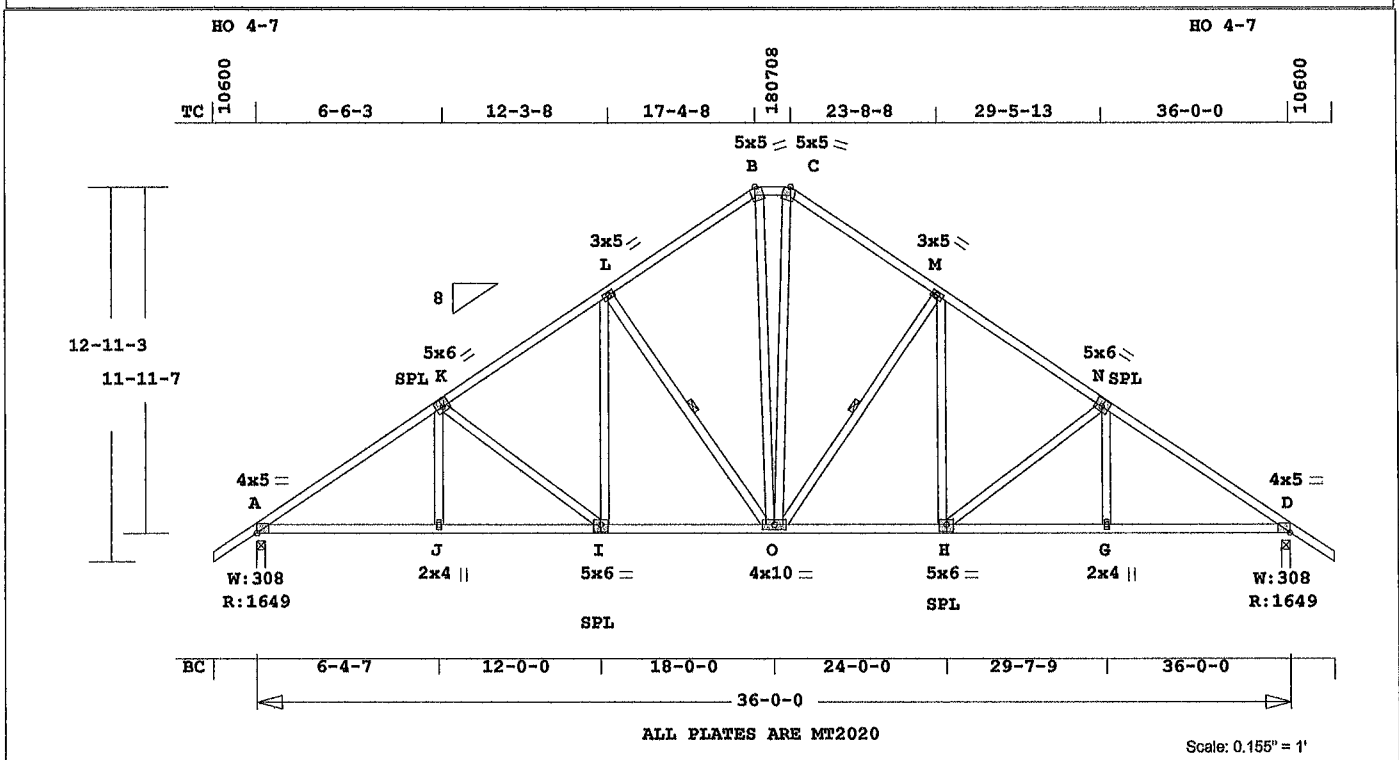

Online Plus -- Version 30.0.023  
RUN DATE: 25-APR-14

Southern Pine lumber design values are those effective 06-01-13 by SPIB//ALSC UON

TC	0.37	2x 4	SP-#2
BC	0.56	2x 4	SP-#2
WB	0.36	2x 4	SP-#2

Brace truss as follows:

TC Cont.	0- 0- 0	36- 0- 0
or	42.0"	0- 0- 0
BC Cont.	0- 0- 0	36- 0- 0
or	120.0"	0- 0- 0

Continuous Lateral Restraint req'd at mid-point of webs:

L - O O - M  
Attach CLR with (2)-10d nails at each web.  
Refer to BCSI for diagonal restraint requirements.

psf-Ld	Dead	Live		
TC	10.0	20.0		
BC	10.0	0.0		
TC+BC	20.0	20.0		
Total	40.0	Spacing 24.0"		
Lumber	Duration Factor	1.25		
Plate	Duration Factor	1.25		
	Fb	Fc	Ft	Emin
TC	1.15	1.10	1.10	1.10
BC	1.10	1.10	1.10	1.10

Total Load Reactions (Lbs)

Jt	Down	Uplift	Horiz-
A	1650	192 R	
D	1650	192 R	

Jt	Brg Size	Required
A	3.5"	1.9"
D	3.5"	1.9"

Plus 21 Wind Load Case(s)  
Plus 1 UBC LL Load Case(s)  
Plus 1 BC LL Load Case(s)  
Plus 1 DL Load Case(s)

Membr CSI P Lbs Ax1-CSI-Bnd

-----Top Chords-----			
A -K	0.37	2302 C	0.04 0.33
K -L	0.33	1915 C	0.03 0.30
L -B	0.30	1464 C	0.01 0.29
B -C	0.08	1237 C	0.04 0.04
C -M	0.30	1464 C	0.01 0.29
M -N	0.33	1915 C	0.03 0.30
N -D	0.37	2302 C	0.04 0.33

Mitek® Online Plus™ APPROX. TRUSS WEIGHT: 307 2 LBS

-----Bottom Chords-----			
A -J	0.52	1914 T	0.39 0.13
J -I	0.56	1914 T	0.39 0.17
I -O	0.55	1592 T	0.32 0.23
O -H	0.55	1592 T	0.32 0.23
H -G	0.56	1914 T	0.39 0.17
G -D	0.52	1914 T	0.39 0.13

-----Webs-----			
J -K	0.04	234 T	
K -I	0.36	415 C	
I -L	0.10	444 T	
L -O	0.29	653 C	1 Br
B -O	0.22	625 T	
O -C	0.22	625 T	
O -M	0.29	653 C	1 Br
H -M	0.10	444 T	
H -N	0.36	415 C	
G -N	0.04	234 T	

TL Defl	-0.29"	in O -H	L/999
LL Defl	-0.13"	in O -H	L/999
Shear // Grain		in A -K	0.19

Plates for each ply each face.  
Plate - MT20 20 Ga, Gross Area  
Plate - MT2H 20 Ga, Gross Area  
Jt Type Plt Size X Y JSI

A	MT20	4.0x 5.0	Ctr	0.1	0.76
K	MT20	5.0x 6.0	0.3	0.5	0.68
L	MT20	3.0x 5.0	Ctr	Ctr	0.37
B	MT20	5.0x 5.0	0.9-3.1	0.61	
C	MT20	5.0x 5.0	0.9-3.1	0.61	
M	MT20	3.0x 5.0	Ctr	Ctr	0.37
N	MT20	5.0x 6.0	0.3	0.5	0.68
D	MT20	4.0x 5.0	Ctr	0.1	0.76
J	MT20	2.0x 4.0	Ctr	0.34	
I	MT20	5.0x 6.0	Ctr	-0.5	0.71
O	MT20	4 0x10.0	Ctr	0.38	
H	MT20	5.0x 6.0	Ctr	-0.5	0.71
G	MT20	2.0x 4.0	Ctr	0.34	

REVIEWED BY:  
Mitek Industries, Inc.  
6904 Parke East Blvd.  
Tampa, FL 33610

REFER TO ONLINE PLUS GENERAL NOTES AND SYMBOLS SHEET FOR ADDITIONAL SPECIFICATIONS.

NOTES:

Trusses Manufactured by:  
Mayo Truss Co. Inc.  
Analysis Conforms To:

FBC2010  
TPI 2007  
OH Loading  
Soffit psf 2.0

This truss has been designed

for 20.0 psf LL on the B.C. in areas where a rectangle 3- 6- 0 tall by 2- 0- 0 wide will fit between the B.C. and any other member.

Design checked for 10 psf non-concurrent LL on BC

Wind Loads - ANSI / ASCE 7-10  
Truss is designed as

Components and Claddings\* for Exterior zone location.

Wind Speed: 120 mph  
Risk Category: II  
Mean Roof Height: 15-0  
Exposure Category: B

Building Type: Enclosed  
TC Dead Load: 6.0 psf  
BC Dead Load: 6.0 psf

Max comp. force 2302 Lbs  
Max tens. force 1914 Lbs

Connector Plate Fabrication

Tolerance = 20%

This truss is designed for a creep factor of 1.5 which is used to calculate total load deflection.

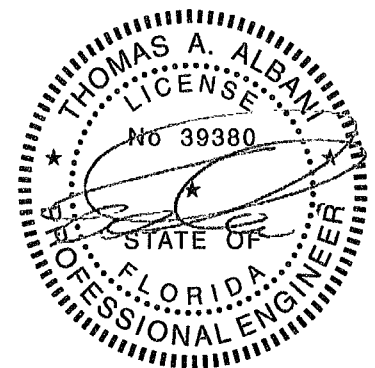

FL Cert. 6634

April 25, 2014

Job <b>INN-CG-1302</b>	Mark <b>A6</b>	Quan <b>1</b>	Type <b>HIPP</b>	Span <b>360000</b>	P1-HI <b>8</b>	Left OH <b>1- 6- 0</b>	Right OH <b>1- 6- 0</b>	Engineering <b>T6277966</b>
---------------------------	-------------------	------------------	---------------------	-----------------------	-------------------	---------------------------	----------------------------	--------------------------------

COTTAGE GROVE MODEL 1302

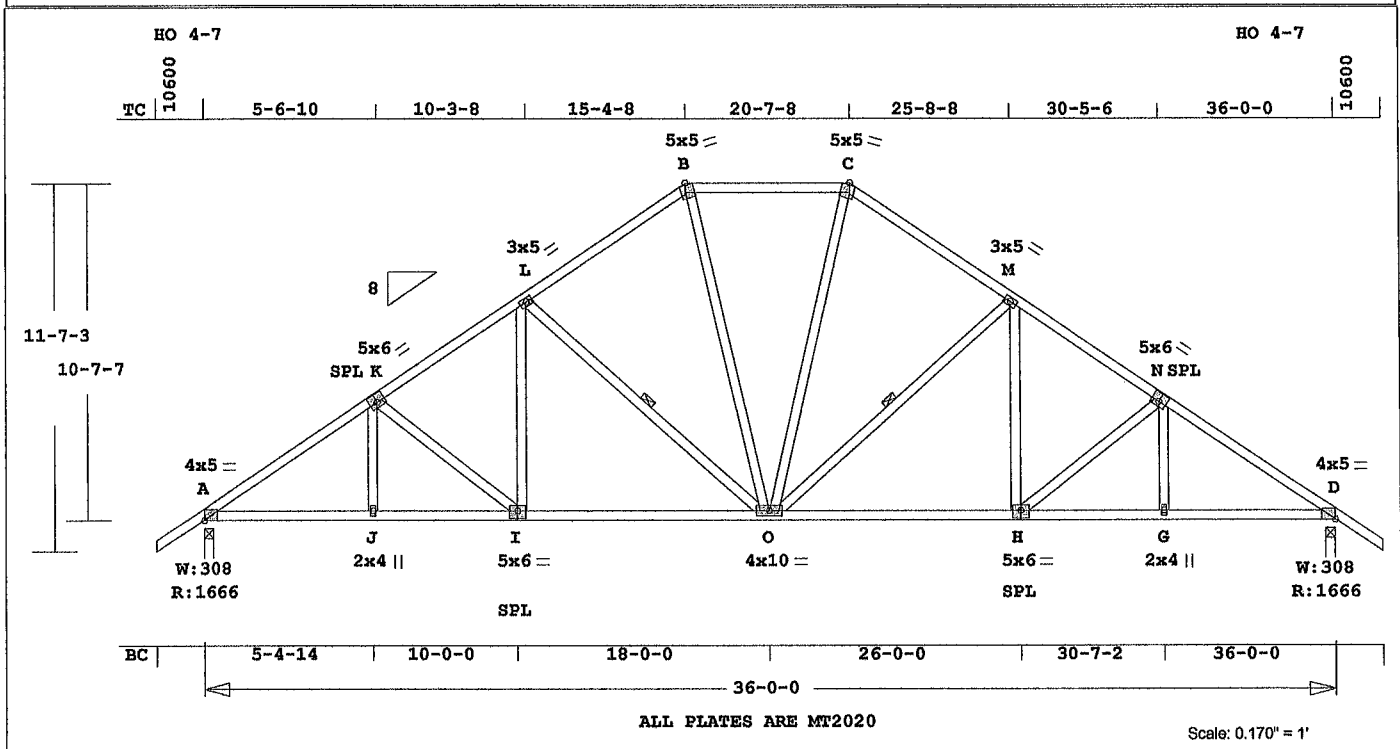

MiTek® Online Plus™ APPROX. TRUSS WEIGHT: 290.9 LBS

Online Plus -- Version 30.0.023  
RUN DATE: 25-APR-14

Southern Pine lumber design values are those effective 06-01-13 by SPIB//ALSC UON  
CSI -Size- ---Lumber---  
TC 0.34 2x 4 SP-#2  
BC 0.74 2x 4 SP-#2  
WB 0.30 2x 4 SP-#2

Brace truss as follows:  
O.C. From To  
TC Cont. 0- 0- 0 36- 0- 0  
or 42.0" 0- 0- 0 36- 0- 0  
BC Cont. 0- 0- 0 36- 0- 0  
or 120.0" 0- 0- 0 36- 0- 0

Continuous Lateral Restraint req'd at mid-point of webs:  
L -O O -M  
Attach CLR with (2)-10d nails at each web.  
Refer to BCSI for diagonal restraint requirements.

psf-Ld	Dead	Live		
TC	10.0	20.0		
BC	10.0	0.0		
TC+BC	20.0	20.0		
Total	40.0	Spacing 24.0"		
Lumber Duration Factor	1.25			
Plate Duration Factor	1.25			
	Fb	Fc	Ft	Emin
TC	1.15	1.10	1.10	1.10
BC	1.10	1.10	1.10	1.10

Total Load Reactions (Lbs)  
Jt Down Uplift Horiz-  
A 1666 169 R  
D 1666 169 R

Jt	Brg Size	Required
A	3.5"	2.0"
D	3.5"	2.0"

Plus 21 Wind Load Case(s)  
Plus 1 UBC LL Load Case(s)  
Plus 1 BC LL Load Case(s)  
Plus 1 DL Load Case(s)

Membr	CSI	P	Lbs	Ax1	CSI-End
-----Top Chords-----					
A -K	0.34	2358	C	0.05	0.29
K -L	0.26	2084	C	0.03	0.23
L -B	0.25	1517	C	0.02	0.23
B -C	0.29	1389	C	0.02	0.27
C -M	0.25	1517	C	0.02	0.23
M -N	0.26	2084	C	0.03	0.23
N -D	0.34	2358	C	0.05	0.29

-----Bottom Chords-----					
A -J	0.58	1956	T	0.40	0.18
J -I	0.68	1956	T	0.40	0.28
I -O	0.74	1736	T	0.35	0.39
O -H	0.74	1736	T	0.35	0.39
H -G	0.68	1956	T	0.40	0.28
G -D	0.58	1956	T	0.40	0.18
-----Webs-----					
J -K	0.03	159	T		
K -I	0.18	307	C		
I -L	0.09	424	T		
L -O	0.30	629	C	1 Br	
B -O	0.12	541	T		
O -C	0.12	541	T		
O -M	0.30	629	C	1 Br	
H -M	0.09	424	T		
H -N	0.18	307	C		
G -N	0.03	159	T		

TL Defl -0.37" in I -O L/999  
LL Defl -0.18" in I -O L/999  
Shear // Grain in I -O 0.22

Plates for each ply each face.  
Plate - MT20 20 Ga, Gross Area  
Plate - MT2H 20 Ga, Gross Area  
Jt Type Plt Size X Y JSI  
A MT20 4.0x 5.0 Ctr 0.1 0.76  
K MT20 5.0x 6.0-0.3 Ctr 0.5 0.50  
L MT20 3.0x 5.0 Ctr Ctr 0.37  
B MT20 5.0x 5.0 0.9-3.1 0.76  
C MT20 5.0x 5.0-0.9-3.1 0.76  
M MT20 3.0x 5.0 Ctr Ctr 0.37  
N MT20 5.0x 6.0 0.3 0.5 0.50  
D MT20 4.0x 5.0 Ctr 0.1 0.78  
J MT20 2.0x 4.0 Ctr Ctr 0.34  
I MT20 5.0x 6.0 Ctr-0.5 0.83  
O MT20 4.0x10.0 Ctr Ctr 0.46  
H MT20 5.0x 6.0 Ctr-0.5 0.83  
G MT20 2.0x 4.0 Ctr Ctr 0.34

REVIEWED BY:  
MiTek Industries, Inc.  
6904 Parke East Blvd.  
Tampa, FL 33610

REFER TO ONLINE PLUS GENERAL NOTES AND SYMBOLS SHEET FOR ADDITIONAL SPECIFICATIONS.

NOTES:  
Trusses Manufactured by:  
Mayo Truss Co. Inc.  
Analysis Conforms To:  
FBC2010  
TPI 2007  
OH Loading  
Soffit psf 2.0  
This truss has been designed

for 20.0 psf LL on the B.C. in areas where a rectangle 3- 6- 0 tall by 2- 0- 0 wide will fit between the B.C. and any other member.  
Design checked for 10 psf non-concurrent LL on BC.  
Wind Loads - ANSI / ASCE 7-10  
Truss is designed as Components and Claddings\* for Exterior zone location.  
Wind Speed: 120 mph  
Risk Category : II  
Mean Roof Height: 15-0  
Exposure Category: B  
Building Type: Enclosed  
TC Dead Load: 6.0 psf  
BC Dead Load: 6.0 psf  
Max comp. force 2358 Lbs  
Max tens. force 1956 Lbs  
Connector Plate Fabrication Tolerance = 20%  
This truss is designed for a creep factor of 1.5 which is used to calculate total load deflection.

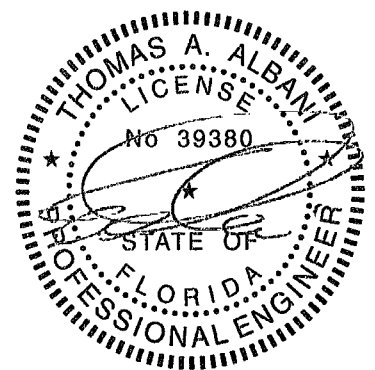

FL Cert. 6634

April 25, 2014

Job <b>INN-CG-1302</b>	Mark <b>A7</b>	Quan <b>1</b>	Type <b>HIPP</b>	Span <b>360000</b>	P1-H1 <b>8</b>	Left OH <b>1- 6- 0</b>	Right OH <b>1- 6- 0</b>	Engineering <b>T6277967</b>
---------------------------	-------------------	------------------	---------------------	-----------------------	-------------------	---------------------------	----------------------------	--------------------------------

COTTAGE GROVE MODEL 1302

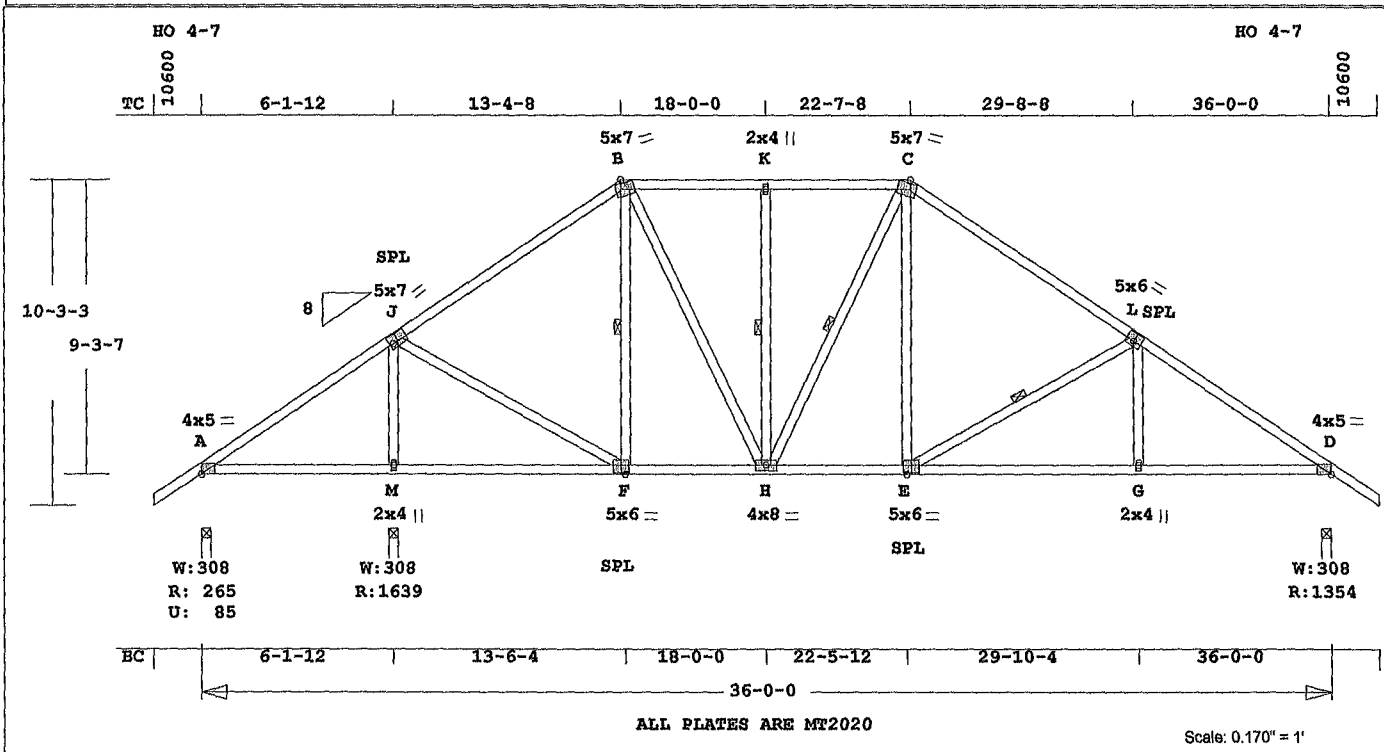

ALL PLATES ARE MT2020

Scale: 0.170" = 1'

Online Plus -- Version 30.0.023  
RUN DATE: 25-APR-14

Southern Pine lumber design values are those effective 06-01-13 by SPIB//ALSC UON  
CSI -Size- ---Lumber---  
TC 0.63 2x 4 SP-#2  
BC 0.50 2x 4 SP-#2  
WB 0.46 2x 4 SP-#2

Brace truss as follows:  
O C. From To  
TC Cont. 0- 0- 0 36- 0- 0  
or 42.0" 0- 0- 0 36- 0- 0  
BC Cont. 0- 0- 0 36- 0- 0  
or 72.0" 0- 0- 0 36- 0- 0

Continuous Lateral Restraint req'd at mid-point of webs:  
F -B H -K H -C E -L  
Attach CLR with (2)-10gd nails at each web.  
Refer to BCSI for diagonal restraint requirements.

psf-Ld	Dead	Live
TC	10.0	20.0
BC	10.0	0.0
TC+BC	20.0	20.0
Total	40.0	Spacing 24.0"
Lumber Duration Factor	1.25	
Plate Duration Factor	1.25	
	Fb	Fc Ft Emin
TC	1.15	1.10 1.10 1.10
BC	1.10	1.10 1.10 1.10

Total Load Reactions (Lbs)			
Jt	Down	Uplift	Horiz
A	265	86 U	146 R
M	1640		
D	1354		147 R

Jt	Brg Size	Required
A	3.5"	1.5"
M	3.5"	1.7"
D	3.5"	1.6"

Plus 21 Wind Load Case(s)  
Plus 1 UBC LL Load Case(s)  
Plus 1 BC LL Load Case(s)  
Plus 1 DL Load Case(s)

Membr	CSI	P Lbs	Ax1	CSI-Bnd
---Top Chords---				
A -J	0.58	148 T	0.03	0.85
J -B	0.58	979 C	0.01	0.57
B -K	0.19	1037 C	0.00	0.19
K -C	0.15	1037 C	0.00	0.15
C -L	0.63	1307 C	0.09	0.54

MiTek® Online Plus™ APPROX TRUSS WEIGHT: 285.0 LBS

Member	Defl	Weight	Notes
L -D	0.47	1821 C	0.02 0.45
---Bottom Chords---			
A -M	0.32	67 C	0.00 0.32
M -F	0.32	67 C	0.00 0.32
F -H	0.32	806 T	0.16 0.16
H -E	0.40	1077 T	0.22 0.18
E -G	0.50	1523 T	0.31 0.19
G -D	0.43	1523 T	0.18 0.25
---Webs---			
M -J	0.46	1474 C	
J -F	0.21	951 T	
F -B	0.10	278 C	1 Br
B -H	0.11	518 T	
H -K	0.09	254 C	1 Br
K -C	0.06	135 C	1 Br
E -C	0.10	449 T	
E -L	0.16	820 C	1 Br
G -L	0.05	276 T	

TL Defl -0.05" in A -M L/999  
LL Defl -0.02" in A -M L/999  
Shear // Grain in J -B 0.25

Plates for each ply each face.  
Plate - MT20 20 Ga, Gross Area  
Plate - MT2H 20 Ga, Gross Area  
Jt Type Plt Size X Y JSI  
A MT20 4.0x 5.0 Ctr 0.1 0.37  
J MT20 5.0x 7.0-0.3 0.5 0.81  
B MT20 5.0x 7.0 1.6-3.4 0.63  
K MT20 2.0x 4.0 Ctr Ctr 0.34  
C MT20 5.0x 7.0-1.6-3.4 0.87  
L MT20 5.0x 6.0 0.3 0.5 0.86  
D MT20 4.0x 5.0 Ctr 0.1 0.60  
M MT20 2.0x 4.0 Ctr Ctr 0.38  
F MT20 5.0x 6.0 Ctr-0.5 0.55  
H MT20 4.0x 8.0 Ctr Ctr 0.26  
E MT20 5.0x 6.0 Ctr-0.5 0.73  
G MT20 2.0x 4.0 Ctr Ctr 0.34

REVIEWED BY:  
MiTek Industries, Inc.  
6904 Parke East Blvd.  
Tampa, FL 33610

REFER TO ONLINE PLUS GENERAL NOTES AND SYMBOLS SHEET FOR ADDITIONAL SPECIFICATIONS.

NOTES:  
Trusses Manufactured by:  
Mayo Truss Co. Inc.  
Analysis Conforms To:  
FBC2010  
TPI 2007  
OH Loading  
Soffit psf 2.0  
This truss has been designed for 20.0 psf LL on the B.C.

in areas where a rectangle 3- 6- 0 tall by 2- 0- 0 wide will fit between the B.C. and any other member.  
Design checked for 10 psf non-concurrent LL on BC.  
Wind Loads - ANSI / ASCE 7-10  
Truss is designed as Components and Claddings\* for Exterior zone location.  
Wind Speed: 120 mph  
Risk Category: II  
Mean Roof Height: 15-0  
Exposure Category: B  
Building Type: Enclosed  
TC Dead Load: 6.0 psf  
BC Dead Load: 6.0 psf  
User-defined wind-exposed BC regions --From-- --To--  
0- 0- 0 6- 1-12  
Max comp. force 1821 Lbs  
Max tens. force 1523 Lbs  
Connector Plate Fabrication Tolerance = 20%  
This truss is designed for a creep factor of 1.5 which is used to calculate total load deflection.

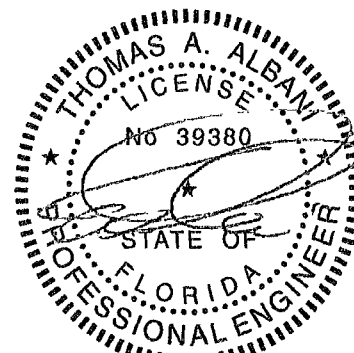

FL Cert. 6634

April 25, 2014

Job <b>INN-CG-1302</b>	Mark <b>A8</b>	Quan 1	Type HIPP	Span 360000	P1-H1 8	Left OH 1- 6- 0	Right OH 1- 6- 0	Engineering T6277968
---------------------------	-------------------	-----------	--------------	----------------	------------	--------------------	---------------------	-------------------------

COTTAGE GROVE MODEL 1302

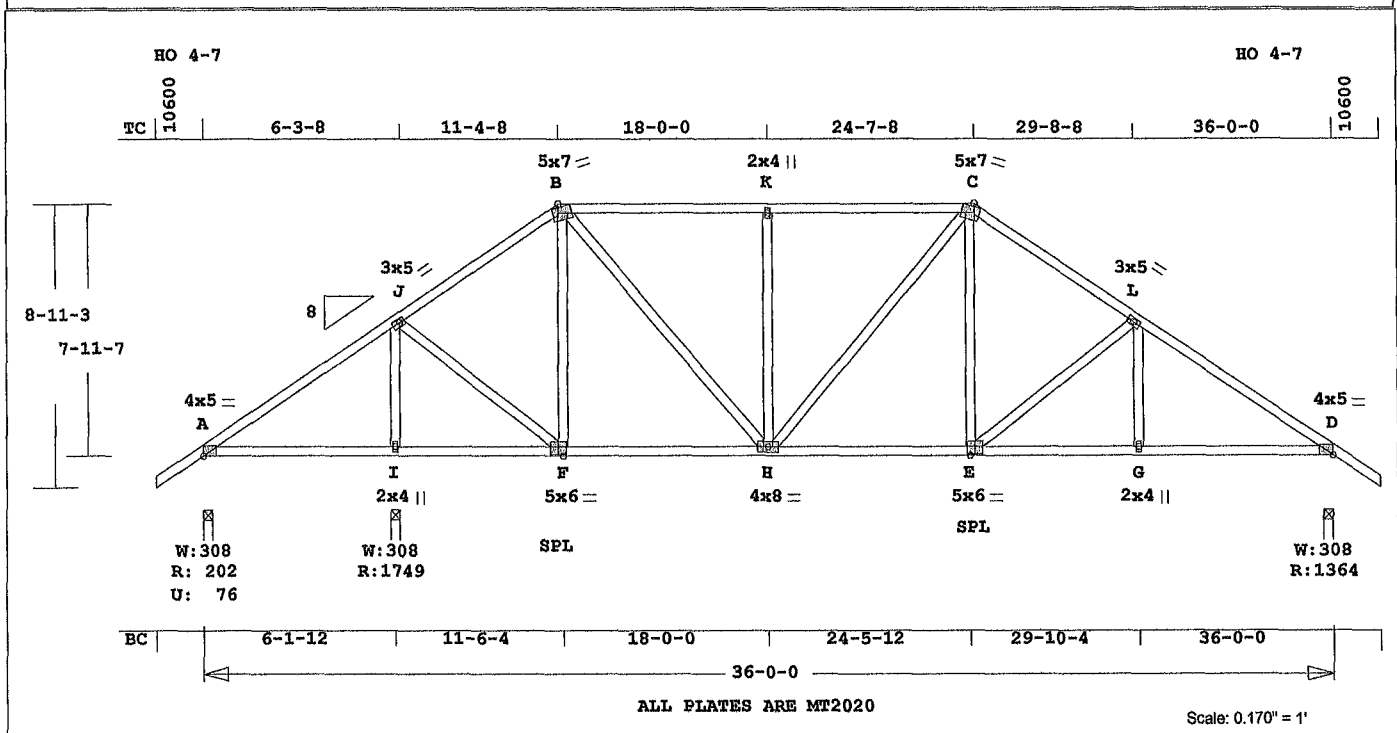

Online Plus -- Version 30 0.023  
RUN DATE: 25-APR-14

Southern Pine Lumber design values are those effective 06-01-13 by SPIB//ALSC VON  
CSI -Size- ---Lumber---  
TC 0.49 2x 4 SP-#2  
BC 0.52 2x 4 SP-#2  
WB 0.50 2x 4 SP-#2

Brace truss as follows:  
O.C. From To  
TC Cont. 0- 0- 0 36- 0- 0  
or 48.0" 0- 0- 0 36- 0- 0  
BC Cont. 0- 0- 0 36- 0- 0  
or 72.0" 0- 0- 0 36- 0- 0

psf-lb	Dead	Live
TC	10.0	20.0
BC	10.0	0.0
TC+BC	20.0	20.0
Total	40.0	Spacing 24.0"
Lumber Duration Factor	1.25	
Plate Duration Factor	1.25	
	Fb	Fo Ft Emin
TC	1.15	1.10 1.10 1.10
BC	1.10	1.10 1.10 1.10

Total Load Reactions (lbs)  
Jt Down Uplift Horiz  
A 203 77 U 124 R  
I 1750  
D 1364 125 R

Jt	Brg Size	Required
A	3.5"	1.5"
I	3.5"	1.9"
D	3.5"	1.6"

Plus 21 Wind Load Case(s)  
Plus 1 UBC LL Load Case(s)  
Plus 1 BC LL Load Case(s)  
Plus 1 DL Load Case(s)

Membr	CSI	P	Lbs	Axl	CSI-Bnd
-----Top Chords-----					
A-J	0.44	190	T	0.05	0.39
J-B	0.39	868	C	0.00	0.39
B-K	0.49	1237	C	0.01	0.48
K-C	0.49	1237	C	0.01	0.48
C-L	0.28	1459	C	0.01	0.27
L-D	0.33	1812	C	0.03	0.30
-----Bottom Chords-----					
A-I	0.27	143	C	0.00	0.27
I-F	0.23	143	C	0.00	0.23

MiTek® Online Plus™ APPROX. TRUSS WEIGHT: 269.4 LBS

F-H	0.43	715	T	0.14	0.29
H-E	0.52	1209	T	0.24	0.28
E-G	0.50	1507	T	0.30	0.20
G-D	0.42	1507	T	0.30	0.12

-----Webs-----					
I-J	0.50	1606	C		
J-F	0.24	1075	T		
F-B	0.47	455	C		
B-H	0.18	804	T		
H-K	0.45	437	C		
H-C	0.09	65	T		
E-C	0.09	441	T		
E-L	0.31	397	C		
G-L	0.04	223	T		

TL Defl -0.08" in A -I L/902  
LL Defl -0.03" in A -I L/999  
Shear // Grain in K -C 0.29

Plates for each ply each face  
Plate - MT20 20 Ga, Gross Area  
Plate - MT2H 20 Ga, Gross Area  
Jt Type Plt Size X Y JSI  
A MT20 4.0x 5.0 Ctr 0.1 0.37  
J MT20 3.0x 5.0-0.4-0.3 0.73  
B MT20 5.0x 7.0 1.6-3.4 0.62  
K MT20 2.0x 4.0 Ctr Ctr 0.34  
C MT20 5.0x 7.0-1.6-3.4 0.83  
L MT20 3.0x 5.0 Ctr Ctr 0.37  
D MT20 4.0x 5.0 Ctr 0.1 0.60  
I MT20 2.0x 4.0 Ctr Ctr 0.41  
F MT20 5.0x 6.0 Ctr-0.5 0.44  
H MT20 4.0x 8.0 Ctr Ctr 0.42  
E MT20 5.0x 6.0 Ctr-0.5 0.63  
G MT20 2.0x 4.0 Ctr Ctr 0.34

REVIEWED BY:  
MiTek Industries, Inc.  
6904 Parke East Blvd.  
Tampa, FL 33610

REFER TO ONLINE PLUS GENERAL NOTES AND SYMBOLS SHEET FOR ADDITIONAL SPECIFICATIONS.

NOTES:  
Trusses Manufactured by:  
Mayo Truss Co. Inc.  
Analysis Conforms To:  
FBC2010  
TPI 2007  
OH Loading  
Soffit psf 2.0  
This truss has been designed for 20.0 psf LL on the B.C. in areas where a rectangle

3- 6- 0 tall by  
2- 0- 0 wide  
will fit between the B.C. and any other member.  
Design checked for 10 psf non-concurrent LL on BC.  
Wind Loads - ANSI / ASCE 7-10  
Truss is designed as Components and Claddings\* for Exterior zone location  
Wind Speed: 120 mph  
Risk Category : II  
Mean Roof Height: 15-0  
Exposure Category: B  
Building Type: Enclosed  
TC Dead Load: 6.0 psf  
BC Dead Load: 6.0 psf  
User-defined wind-exposed BC regions --From-- --To--  
0- 0- 0 6- 1-12  
Max comp. force 1812 Lbs  
Max tens. force 1507 Lbs  
Connector Plate Fabrication  
Tolerance = 20%  
This truss is designed for a creep factor of 1.5 which is used to calculate total load deflection.

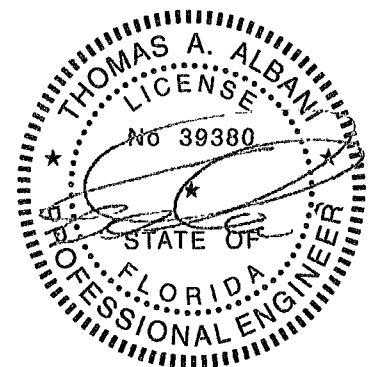

FL Cert. 6634

Job <b>INN-CG-1302</b>	Mark <b>A9</b>	Quan 1	Type HIPP	Span 360000	P1-H1 8	Left OH 1- 6- 0	Right OH 1- 6- 0	Engineering T6277969
---------------------------	-------------------	-----------	--------------	----------------	------------	--------------------	---------------------	-------------------------

COTTAGE GROVE MODEL 1302

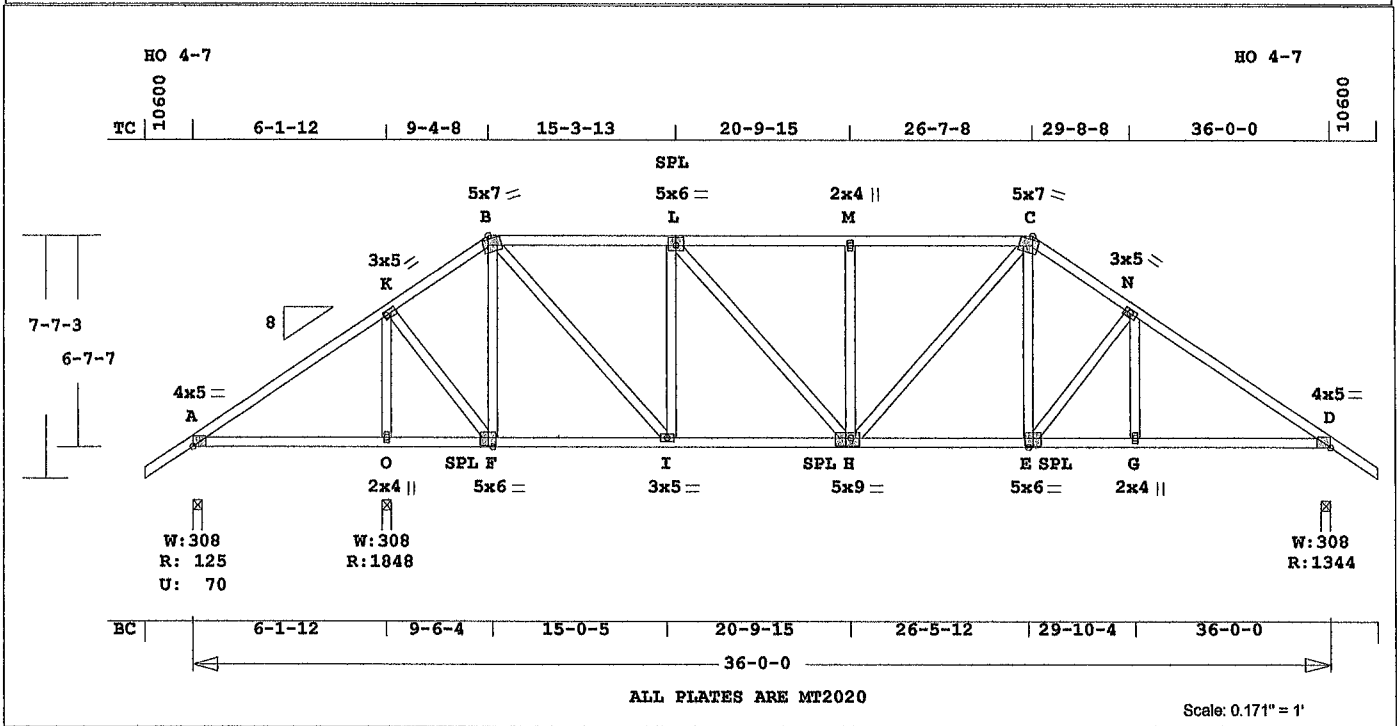

Online Plus -- Version 30.0.023  
RUN DATE: 25-APR-14

Southern Pine Lumber design  
values are those effective  
06-01-13 by SPIB//ALSC UON  
CSI -Size- ---Lumber---  
TC 0.45 2x 4 SP-#2  
BC 0.44 2x 4 SP-#2  
WB 0.53 2x 4 SP-#2

Brace truss as follows:  
O.C. From To  
TC Cont. 0- 0- 0 36- 0- 0  
or 42.0" 0- 0- 0 36- 0- 0  
BC Cont. 0- 0- 0 36- 0- 0  
or 72.0" 0- 0- 0 36- 0- 0

psf-Ld Dead Live  
TC 10.0 20.0  
BC 10.0 0.0  
TC+BC 20.0 20.0  
Total 40 0 Spacing 24.0"  
Lumber Duration Factor 1.25  
Plate Duration Factor 1.25  
TC Fb Fc Ft Emin  
1.15 1.10 1.10 1.10  
BC 1.10 1.10 1.10 1.10

Total Load Reactions (Lbs)  
Jt Down Uplift Horiz-  
A 125 71 U 102 R  
O 1849  
D 1345 103 R

Jt Brg Size Required  
A 3.5" 1.5"  
O 3.5" 2.0"  
D 3.5" 1.6"

Plus 21 Wind Load Case(s)  
Plus 1 UBC LL Load Case(s)  
Plus 1 BC LL Load Case(s)  
Plus 1 DL Load Case(s)

Membr	CSI	P	Lbs	Ax1	CSI-Bnd
---Top Chords---					
A -K	0.45	320	T	0.08	0.37
K -B	0.34	583	C	0.00	0.34
B -L	0.30	1230	C	0.01	0.29
L -M	0.35	1491	C	0.01	0.34
M -C	0.36	1491	C	0.01	0.35
C -N	0.23	1551	C	0.01	0.22
N -D	0.37	1772	C	0.05	0.32
---Bottom Chords---					
A -O	0.30	255	C	0.00	0.30
O -F	0.21	255	C	0.00	0.21
F -I	0.28	472	T	0.09	0.19
I -H	0.43	1230	T	0.25	0.18
H -E	0.43	1288	T	0.26	0.17

MiTek® Online Plus™ APPROX TRUSS WEIGHT. 275.7 LBS

E -G 0.42 1469 T 0.30 0.12  
G -D 0.44 1469 T 0.30 0.14

---Webs---  
O -K 0.53 1703 C  
K -F 0.25 1134 T  
F -B 0.52 749 C  
B -I 0.25 1131 T  
I -L 0.44 633 C  
L -H 0.08 391 T  
H -M 0.25 369 C  
M -C 0.06 302 T  
E -C 0.08 377 T  
E -N 0.15 316 C  
G -N 0.03 185 T

TL Defl -0.08" in A -O L/828  
LL Defl -0.03" in A -O L/999  
Shear // Grain in M -C 0.25

Plates for each ply each face.  
Plate - MT20 20 Ga, Gross Area  
Plate - MT2H 20 Ga, Gross Area  
Jt Type Plt Size X Y JSI  
A MT20 4.0x 5.0 Ctr 0.1 0.37  
K MT20 3.0x 5.0-0.4-0.3 0.82  
B MT20 5.0x 7.0 1.6-3.4 0.87  
L MT20 5.0x 6.0 Ctr 0.5 0.59  
M MT20 2.0x 4.0 Ctr Ctr 0.34  
C MT20 5.0x 7.0-1.6-3.4 0.72  
N MT20 3.0x 5.0 Ctr Ctr 0.37  
D MT20 4.0x 5.0 Ctr 0.1 0.59  
O MT20 2.0x 4.0 Ctr Ctr 0.44  
F MT20 5.0x 6.0 Ctr-0.5 0.47  
I MT20 3.0x 5.0 Ctr Ctr 0.70  
H MT20 5.0x 9.0 0.5-0.5 0.47  
E MT20 5.0x 6.0 Ctr-0.5 0.51  
G MT20 2.0x 4.0 Ctr Ctr 0.34

REVIEWED BY:  
MiTek Industries, Inc.  
6904 Parke East Blvd.  
Tampa, FL 33610

REFER TO ONLINE PLUS GENERAL  
NOTES AND SYMBOLS SHEET FOR  
ADDITIONAL SPECIFICATIONS.

NOTES:  
Trusses Manufactured by:  
Mayo Truss Co. Inc.  
Analysis Conforms To:  
FEC2010  
TPI 2007  
OH Loading  
Soffit psf 2.0  
This truss has been designed  
for 20.0 psf LL on the B.C.  
in areas where a rectangle  
3- 6- 0 tall by  
2- 0- 0 wide

will fit between the B.C.  
and any other member.  
Design checked for 10 psf non-  
concurrent LL on BC.  
Wind Loads - ANSI / ASCE 7-10  
Truss is designed as  
Components and Claddings\*  
for Exterior zone location.  
Wind Speed: 120 mph  
Risk Category : II  
Mean Roof Height: 15-0  
Exposure Category: B  
Building Type: Enclosed  
TC Dead Load: 6.0 psf  
BC Dead Load: 6.0 psf  
User-defined wind-exposed BC  
regions --From-- ---To---  
0- 0- 0 6- 1-12  
Max comp. force 1772 Lbs  
Max tens. force 1469 Lbs  
Connector Plate Fabrication  
Tolerance = 20%  
This truss is designed for a  
creep factor of 1.5 which  
is used to calculate total  
load deflection.

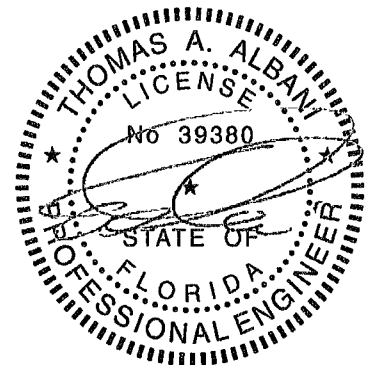

FL Cert. 6634

April 25, 2014

Job <b>INN-CG-1302</b>	Mark <b>A10</b>	Quan 1	Type HIPP	Span 360000	Pl-H1 8	Left OH 1- 6- 0	Right OH 1- 6- 0	Engineering T6277970
---------------------------	--------------------	-----------	--------------	----------------	------------	--------------------	---------------------	-------------------------

COTTAGE GROVE MODEL 1302

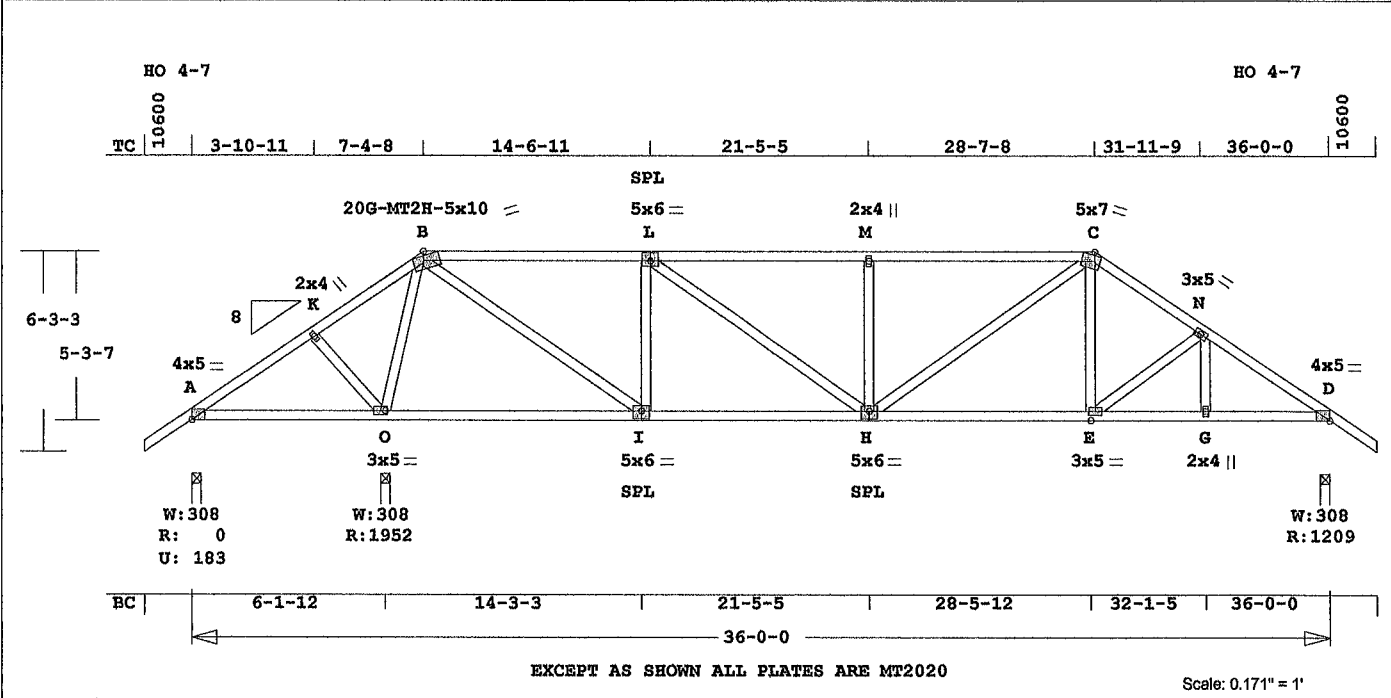

EXCEPT AS SHOWN ALL PLATES ARE MT2020

Scale: 0.171" = 1'

Online Plus -- Version 30.0.023  
RUN DATE: 25-APR-14

Southern Pine lumber design values are those effective 06-01-13 by SPIB//ALSC UON  
CSI -Size- Lumber-----  
TC 0.56 2x 4 SP-#2  
BC 0.46 2x 4 SP-#2  
WB 0.74 2x 4 SP-#2

Brace truss as follows:  
O.C. From To  
TC Cont. 0- 0- 0 36- 0- 0  
or 48.0" 0- 0- 0 36- 0- 0  
BC Cont. 0- 0- 0 36- 0- 0  
or 72.0" 0- 0- 0 36- 0- 0

psf-Ld Dead Live  
TC 10 0 20.0  
BC 10.0 0 0  
TC+BC 20.0 20.0  
Total 40.0 Spacing 24.0"  
Lumber Duration Factor 1.25  
Plate Duration Factor 1.25  
Fb Fc Ft Emin  
TC 1.15 1.10 1.10 1.10  
BC 1.10 1.10 1.10 1.10

Total Load Reactions (Lbs)  
Jt Down Uplift Horiz-  
A 183 U 80 R  
O 1952  
D 1209 81 R

Jt Brg Size Required  
A 3.5" 1.5"  
O 3.5" 2.1"  
D 3.5" 1.5"

Plus 21 Wind Load Case(s)  
Plus 1 UBC LL Load Case(s)  
Plus 1 DL Load Case(s)

Membr	CSI	P	Lbs	Ax1	CSI-Bnd
-----Top Chords-----					
A -K	0.39	558	T	0.12	0.27
K -B	0.43	714	T	0.13	0.30
B -L	0.48	1106	C	0.01	0.47
L -M	0.54	1583	C	0.02	0.52
M -C	0.56	1583	C	0.02	0.54
C -N	0.26	1442	C	0.01	0.25
N -D	0.21	1622	C	0.02	0.19
-----Bottom Chords-----					
A -O	0.36	439	C	0.00	0.36
O -I	0.38	241	C	0.00	0.38
I -H	0.46	1106	T	0.14	0.32
H -E	0.42	1213	T	0.15	0.27

Mitek® Online Plus™ APPROX. TRUSS WEIGHT. 250.1 LBS

E -G	0.39	1336	T	0.27	0.12
G -D	0.39	1336	T	0.27	0.12
-----Webs-----					
K -O	0.06	286	C		
O -B	0.74	1616	C		
B -I	0.36	1613	T		
I -L	0.32	746	C		
L -H	0.13	585	T		
H -M	0.19	454	C		
H -C	0.10	450	T		
E -C	0.05	299	T		
E -N	0.06	184	C		
G -N	0.01	88	T		

TL Defl -0.25" in H -E L/999  
LL Defl -0.10" in O -I L/999  
Shear // Grain in M -C 0.30

Plates for each ply each face.  
Plate - MT20 20 Ga, Gross Area  
Plate - MT2H 20 Ga, Gross Area  
Jt Type Plt Size X Y JSI

A	MT20	4.0x 5.0	Ctr	0.1	0.37
K	MT20	2.0x 4.0	Ctr	Ctr	0.30
B	MT2H	5.0x10.0	1.2-3.8	0.90	
L	MT20	5.0x 6.0	Ctr	0.5	0.82
M	MT20	2.0x 4.0	Ctr	Ctr	0.34
C	MT20	5.0x 7.0	1.6-3.4	0.77	
N	MT20	3.0x 5.0	Ctr	Ctr	0.37
D	MT20	4.0x 5.0	Ctr	0.1	0.54
O	MT20	3.0x 5.0	Ctr	Ctr	0.63
I	MT20	5.0x 6.0	Ctr	0.5	0.76
H	MT20	5.0x 6.0	Ctr	0.5	0.70
E	MT20	3.0x 5.0	Ctr	Ctr	0.33
G	MT20	2.0x 4.0	Ctr	Ctr	0.34

REVIEWED BY:  
Mitek Industries, Inc.  
6904 Parke East Blvd.  
Tampa, FL 33610

REFER TO ONLINE PLUS GENERAL NOTES AND SYMBOLS SHEET FOR ADDITIONAL SPECIFICATIONS.

NOTES:  
Trusses Manufactured by:  
Mayo Truss Co. Inc.  
Analysis Conforms To:  
FBC2010  
FPI 2007  
OH Loading  
Soffit psf 2.0  
This truss has been designed for 20.0 psf LL on the B.C. in areas where a rectangle 3- 6- 0 tall by 2- 0- 0 wide

will fit between the B.C. and any other member.  
Design checked for 10 psf non-concurrent LL on BC.  
Wind Loads - ANSI / ASCE 7-10  
Truss is designed as Components and Claddings\* for Exterior zone location.  
Wind Speed: 120 mph  
Risk Category : II  
Mean Roof Height: 15-0  
Exposure Category: B  
Building Type: Enclosed  
TC Dead Load: 6.0 psf  
BC Dead Load: 6.0 psf  
User-defined wind-exposed BC regions --From-- --To--  
0- 0- 0 6- 1-12  
Max comp. force 1622 Lbs  
Max tens. force 1613 Lbs  
Connector Plate Fabrication Tolerance = 20%  
This truss is designed for a creep factor of 1.5 which is used to calculate total load deflection.

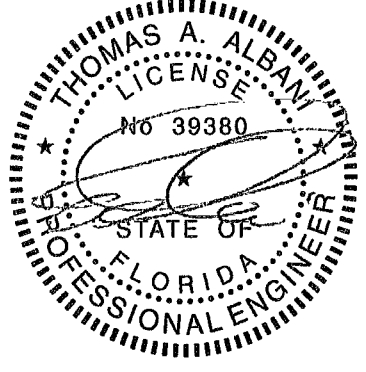

FL Cert. 6634

Job <b>INN-CG-1302</b>	Mark <b>A11GIR</b>	Quan 1	Type HIPP	Span 360000	P1-H1 8	Left OH 1- 6- 0	Right OH 1- 6- 0	Engineering T6277971
---------------------------	-----------------------	-----------	--------------	----------------	------------	--------------------	---------------------	-------------------------

COTTAGE GROVE MODEL 1302

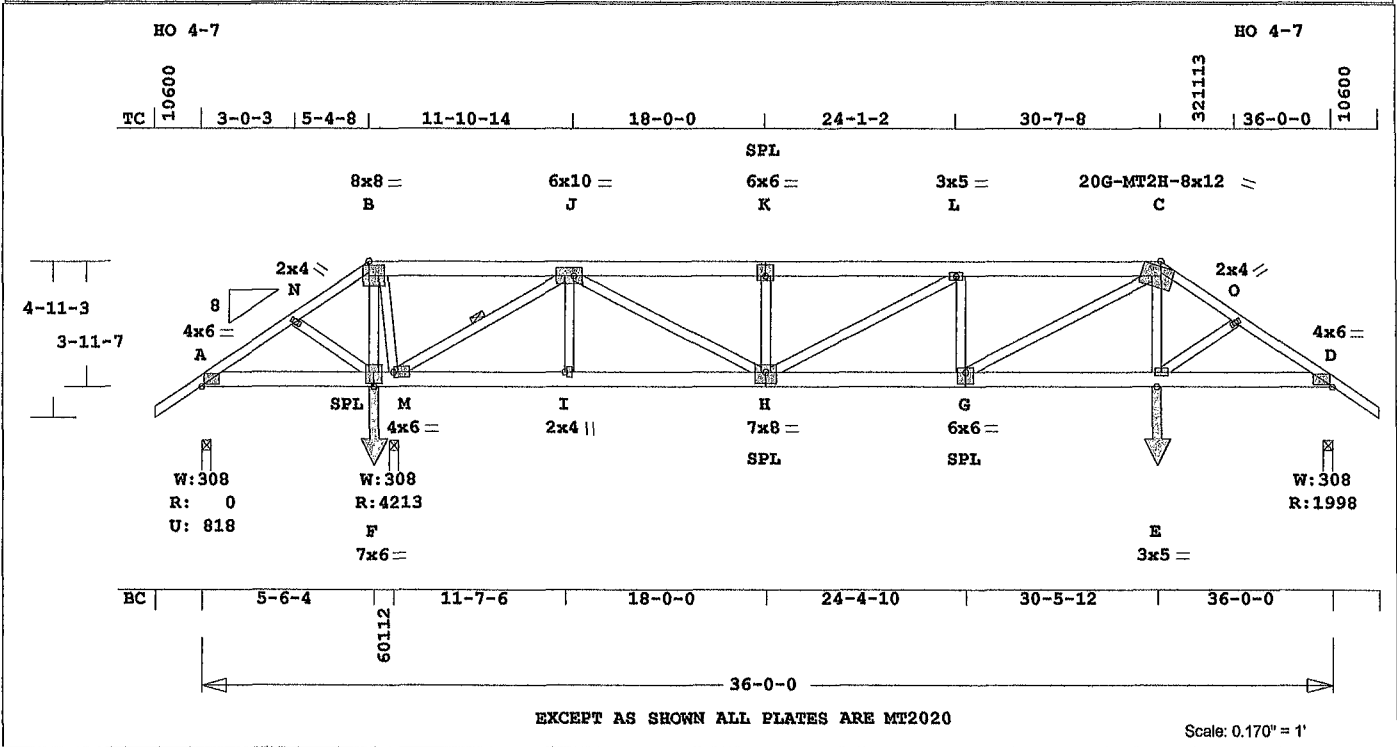

Online Plus -- Version 30.0.023  
RUN DATE 25-APR-14

Southern Pine Lumber design values are those effective 06-01-13 by SPIB//ALSC UON  
CSI -Size- ---Lumber---  
TC 0 75 2x 4 SP-#2  
-- 0 65 2x 6 SP-#2  
B -K K -C  
BC 0 75 2x 6 SP-#2  
WB 0 81 2x 4 SP-#2

Brace truss as follows  
O C. From To  
TC Cont. 0- 0- 0 36- 0- 0  
or 30 0" 0- 0- 0 36- 0- 0  
BC Cont 0- 0- 0 36- 0- 0  
or 60 0" 0- 0- 0 36- 0- 0

Continuous Lateral Restraint req'd at mid-point of webs:  
M -J  
Attach CLR with (2)-10d nails at each web.  
Refer to BCSI for diagonal restraint requirements.

psf-Ld	Dead	Live
TC	10.0	20.0
BC	10.0	0.0
TC+BC	20.0	20.0
Total	40.0	Spacing 24.0"
Lumber Duration Factor	1.25	
Plate Duration Factor	1.25	
	Fb	Fc Ft Emin
TC	1.00	1.00 1.00 1.00
BC	1.00	1.00 1.00 1.00

Total Load Reactions (Lbs)  
Jt Down Uplift Horiz-  
A 818 U 56 R  
M 4214  
D 1998 57 R  
Jt Brg Size Required  
A 3.5" 1.5"  
M 3.5" 4.5" \*\*  
D 3.5" 2.4"

LC# 1 Girder Loading  
Dur Foftrs - Lbr 1.25 Plt 1 25  
plF - Dead Live\* From To  
TC V 20 40 0.0' 36.0'  
BC V 20 0 0.0' 36.0'  
TC V 17 34 5.4' 30.6'  
BC V 17 0 5.5' 30.5'  
BC V 157 157 5.5' CL-LB

MiTek® Online Plus™ APPROX  
BC V 157 157 30 5' CL-LB  
Plus 21 Wind Load Case(s)  
Plus 1 UBC LL Load Case(s)  
Plus 1 DL Load Case(s)

Membr	CSI	P	Lbs	Ax1	CSI-End
-----Top Chords-----					
A -N	0.67	1791	T	0.41	0.26
N -B	0.75	1968	T	0.45	0.30
B -J	0.65	1903	T	0.30	0.35
J -K	0.40	3454	C	0.05	0.35
K -L	0.41	3454	C	0.05	0.36
L -C	0.51	3917	C	0.09	0.42
C -O	0.44	2979	C	0.09	0.35
O -D	0.29	3049	C	0.10	0.19
-----Bottom Chords-----					
A -F	0.12	1455	C	0.00	0.12
F -M	0.32	1693	C	0.01	0.31
M -I	0.53	1396	T	0.22	0.31
I -H	0.37	1396	T	0.22	0.15
H -G	0.75	3917	T	0.63	0.12
G -E	0.56	2508	T	0.40	0.16
E -D	0.45	2508	T	0.40	0.05
-----Webs-----					
N -F	0.05	282	C		
F -B	0.04	189	T		
B -M	0.35	1652	C		
M -J	0.81	3875	C	1 Br	
I -J	0.07	405	T		
J -H	0.53	2358	T		
H -K	0.13	659	C		
K -L	0.45	530	C		
L -C	0.10	500	C		
G -C	0.35	1593	T		
E -C	0.10	530	T		
E -O	0.01	65	T		

TL Defl -0.42" in H -G L/946  
LL Defl -0.16" in H -G L/999  
Shear // Grain in L -C 0.33

Plates for each ply each face.  
Plate - MT20 20 Ga, Gross Area  
Plate - MT2H 20 Ga, Gross Area  
Jt Type Plt Size X Y JSI  
A MT20 4.0x 6.0 Ctr Ctr 0.51  
N MT20 2.0x 4.0 Ctr Ctr 0.30  
B MT20 8.0x 8.0 Ctr Ctr 0.89  
J MT20 6.0x10.0 Ctr Ctr 0.93  
K MT20 6.0x 6.0 Ctr 1.2 0 70  
L MT20 3.0x 5.0 Ctr Ctr 0.33  
C MT2H 8.0x12.0-1.7-5.6 0.99  
O MT20 2.0x 4.0 Ctr Ctr 0.32  
D MT20 4.0x 6.0 Ctr Ctr 0.88  
F MT20 7.0x 6.0 Ctr-0.8 0.47  
M MT20 4.0x 6.0 1.5 Ctr 0.90

TRUSS WEIGHT: 300.4 LBS  
I MT20 2.0x 4.0 Ctr Ctr 0 37  
H MT20 7.0x 8.0 Ctr-0.8 0 93  
G MT20 6.0x 6.0 Ctr-1.2 0 96  
E MT20 3.0x 5.0 Ctr Ctr 0 33

REVIEWED BY:  
MiTek Industries, Inc  
6904 Parke East Blvd  
Tampa, FL 33610

REFER TO ONLINE PLUS GENERAL NOTES AND SYMBOLS SHEET FOR ADDITIONAL SPECIFICATIONS

NOTES:  
Trusses Manufactured by Mayo Truss Co Inc  
Analysis Conforms To FBC2010  
TFI 2007  
Girder Step Down Hip  
Framing King Jacks  
Jack Open Faced  
Setback 5- 4- 8

OH Loading  
Soffit psf 2 0  
Design checked for 10 psf non-concurrent LL on BC  
Wind Loads - ANSI / ASCE 7-10  
Truss is designed as Components and Claddings\* for Exterior zone location.  
Wind Speed: 120 mph  
Risk Category : II  
Mean Roof Height: 15-0  
Exposure Category B  
Building Type: Enclosed  
TC Dead Load: 6.0 psf  
BC Dead Load: 6.0 psf  
User-defined wind-exposed BC regions --From-- ---To---  
0- 0- 0 6- 1-12  
Max comp. force 3917 Lbs  
Max tens. force 3917 Lbs  
Connector Plate Fabrication Tolerance = 20%  
This truss is designed for a creep factor of 1.5 which is used to calculate total load deflection.

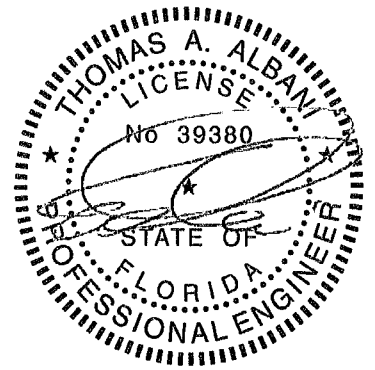

FL Cert. 6634

Job <b>INN-CG-1302</b>	Mark <b>B1</b>	Quan 5	Type TR	Span 210400	P1-H1 8	Left OH 1- 6- 0	Right OH 1- 6- 0	Engineering <b>T6277972</b>
---------------------------	-------------------	-----------	------------	----------------	------------	--------------------	---------------------	--------------------------------

COTTAGE GROVE MODEL 1302

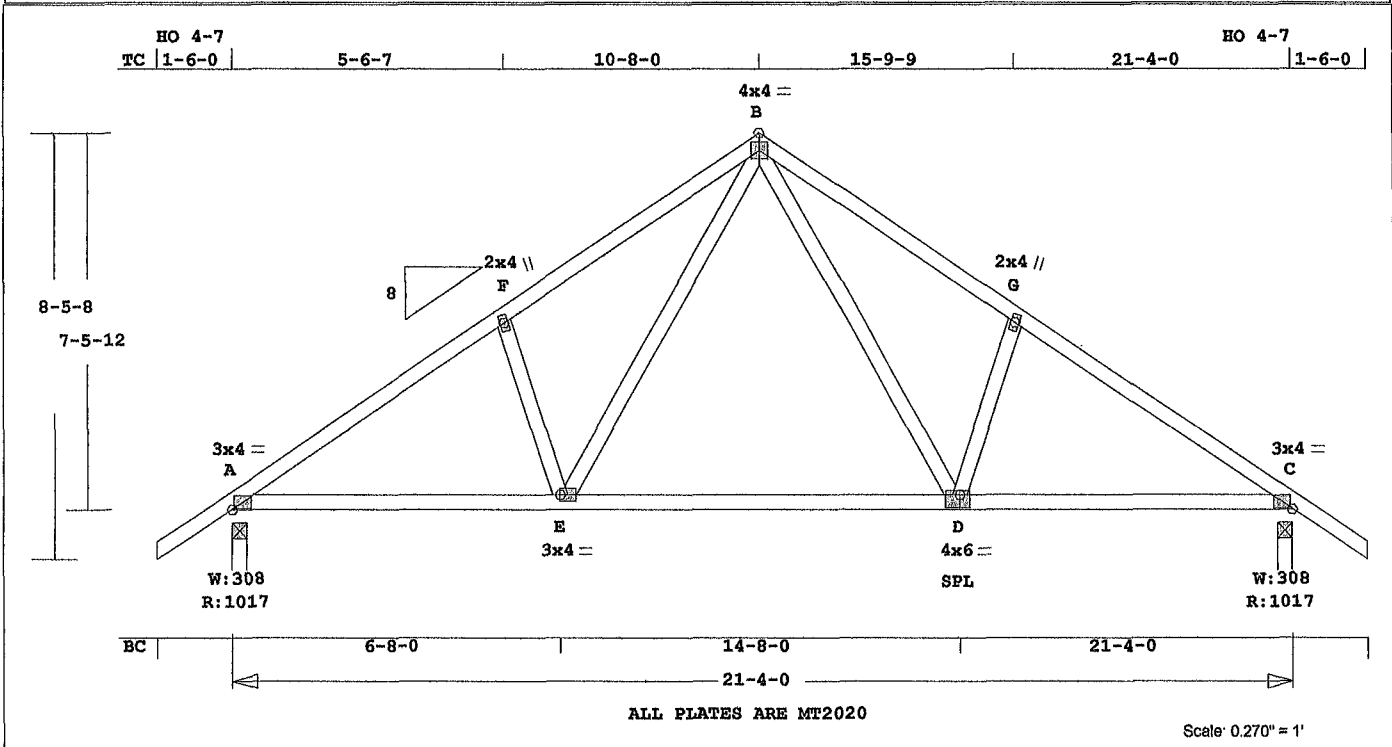

MiTek® Online Plus™ APPROX. TRUSS WEIGHT 139.8 LBS

Online Plus -- Version 30.0.023  
RUN DATE: 25-APR-14

Southern Pine lumber design values are those effective 06-01-13 by SPIB//ALSC UON  
CSI -Size- Lumber-  
TC 0.25 2x 4 SP-#2  
BC 0.65 2x 4 SP-#2  
WB 0.12 2x 4 SP-#2

Brace truss as follows:  
O.C. From To  
TC Cont. 0- 0- 0 21- 4- 0  
or 48.0" 0- 0- 0 21- 4- 0  
BC Cont. 0- 0- 0 21- 4- 0  
or 120.0" 0- 0- 0 21- 4- 0

psf-ld	Dead	Live		
TC	10.0	20.0		
BC	10.0	0.0		
TC+BC	20.0	20.0		
Total	40.0	Spacing 24.0"		
Lumber	Duration Factor	1.25		
Plate	Duration Factor	1.25		
	Fb	Fc	Ft	Emin
TC	1.15	1.10	1.10	1.10
BC	1.10	1.10	1.10	1.10

Total Load Reactions (Lbs)  
Jt Down Uplift Horiz-  
A 1018 108 R  
C 1018 108 R

Jt	Brg Size	Required
A	3.5"	1.5"
C	3.5"	1.5"

Plus 21 Wind Load Case(s)  
Plus 1 UBC LL Load Case(s)  
Plus 1 BC LL Load Case(s)  
Plus 1 DL Load Case(s)

Membr	CSI	P	Lbs	Axl	CSI-Bnd
-----Top Chords-----					
A	-F	0.25	1267	C	0.01 0.24
F	-B	0.25	1169	C	0.01 0.24
B	-G	0.25	1169	C	0.01 0.24
G	-C	0.25	1267	C	0.01 0.24

-----Bottom Chords-----					
A	-E	0.55	1055	T	0.21 0.34
E	-D	0.65	684	T	0.14 0.51
D	-C	0.55	1055	T	0.21 0.34
-----Webs-----					
F	-E	0.07	276	C	
E	-B	0.12	571	T	
B	-D	0.12	571	T	
D	-G	0.07	276	C	

TL Defl -0.21" in E -D L/999  
LL Defl -0.10" in E -D L/999  
Shear // Grain in E -D 0.19

Plates for each ply each face.  
Plate - MT20 20 Ga, Gross Area  
Plate - MT2H 20 Ga, Gross Area  
Jt Type Plt Size X Y JSI  
A MT20 3.0x 4.0 Ctr Ctr 0.74  
F MT20 2.0x 4.0 Ctr Ctr 0.29  
B MT20 4.0x 4.0 Ctr Ctr 0.71  
G MT20 2.0x 4.0 Ctr Ctr 0.29  
C MT20 3.0x 4.0 Ctr Ctr 0.74  
E MT20 3.0x 4.0 Ctr Ctr 0.44  
D MT20 4.0x 6.0-0.5-1.0 0.93

REVIEWED BY:  
MiTek Industries, Inc.  
6904 Parke East Blvd.  
Tampa, FL 33610

REFER TO ONLINE PLUS GENERAL NOTES AND SYMBOLS SHEET FOR ADDITIONAL SPECIFICATIONS.

NOTES:  
Trusses Manufactured by:  
Mayo Truss Co. Inc.  
Analysis Conforms To:  
FBC2010  
TPI 2007  
OH Loading  
Soffit psf 2.0

This truss has been designed for 20.0 psf LL on the B.C. in areas where a rectangle 3- 6- 0 tall by 2- 0- 0 wide will fit between the B.C.

and any other member.  
Design checked for 10 psf non-concurrent LL on BC.  
Wind Loads - ANSI / ASCE 7-10  
Truss is designed as Components and Claddings\* for Exterior zone location.  
Wind Speed: 120 mph  
Risk Category : II  
Mean Roof Height: 15-0  
Exposure Category: B  
Building Type: Enclosed  
TC Dead Load: 6.0 psf  
BC Dead Load: 6.0 psf  
Max comp. force 1267 Lbs  
Max tens. force 1055 Lbs  
Connector Plate Fabrication Tolerance = 20%  
This truss is designed for a creep factor of 1.5 which is used to calculate total load deflection.

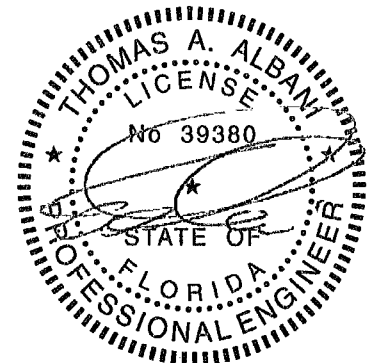

FL Cert. 6634

April 25, 2014

Job <b>INN-CG-1302</b>	Mark <b>B2</b>	Quan 4	Type TR	Span 210400	P1-H1 8	Left OH 0	Right OH 1- 6- 0	Engineering <b>T6277973</b>
---------------------------	-------------------	-----------	------------	----------------	------------	--------------	---------------------	--------------------------------

COTTAGE GROVE MODEL 1302

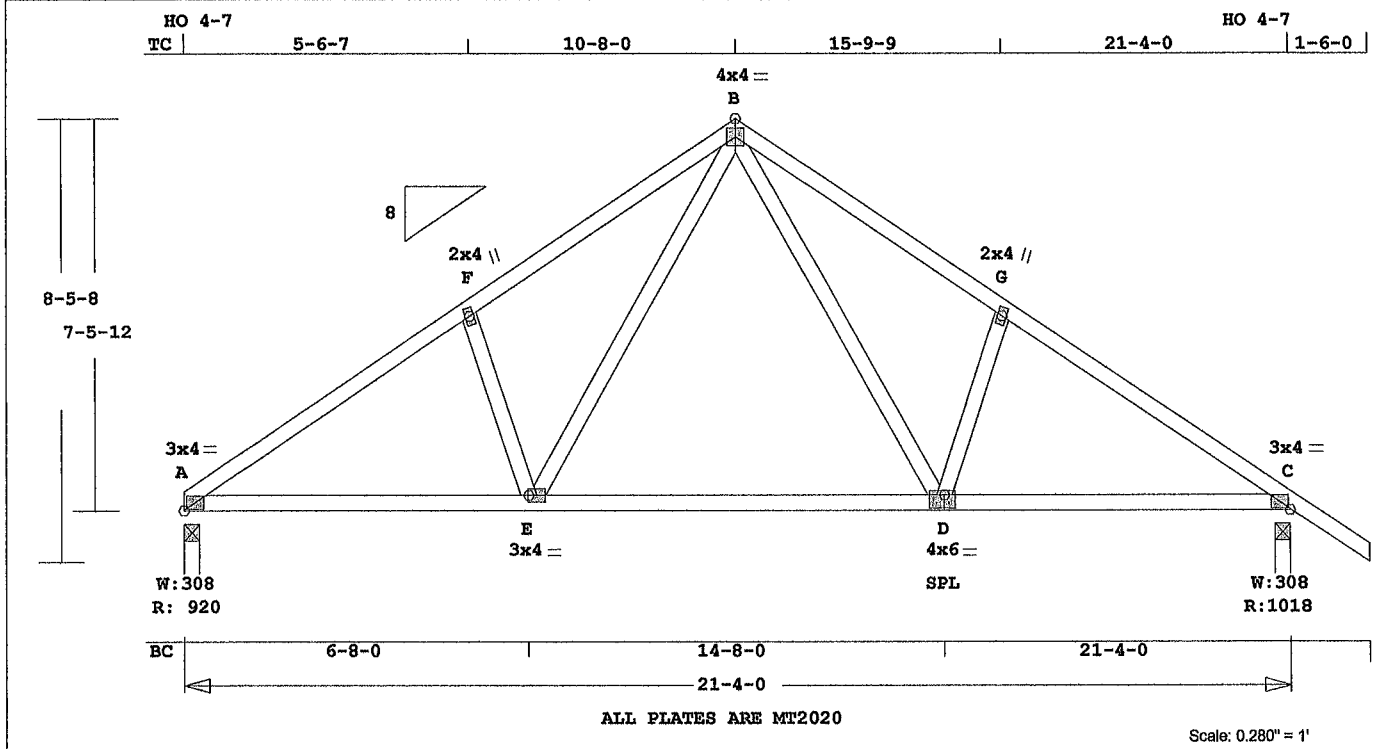

ALL PLATES ARE MT2020

Scale: 0.280" = 1'

Online Plus -- Version 30.0.023  
RUN DATE: 25-APR-14

Southern Pine lumber design values are those effective  
06-01-13 by SPIB//ALSC UON  
CSI -Size- Lumber-----  
TC 0.26 2x 4 SP-#2  
BC 0.65 2x 4 SP-#2  
WB 0.12 2x 4 SP-#2

Brace truss as follows:  
O.C. From To  
TC Cont. 0- 0- 0 21- 4- 0  
or 48.0" 0- 0- 0 21- 4- 0  
BC Cont. 0- 0- 0 21- 4- 0  
or 120.0" 0- 0- 0 21- 4- 0

psf-I'd	Dead	Live
TC	10.0	20.0
BC	10.0	0.0
TC+BC	20.0	20.0
Total	40.0	Spacing 24.0"
Lumber Duration Factor	1.25	
Plate Duration Factor	1.25	
	Fb	Fc Ft Emin
TC	1.15	1.10 1.10 1.10
BC	1.10	1.10 1.10 1.10

Total Load Reactions (Lbs)  
Jt Down Uplift Horiz-  
A 921 108 R  
C 1018 108 R

Jt	Brg Size	Required
A	3.5"	1.5"
C	3.5"	1.5"

Plus 21 Wind Load Case(s)  
Plus 1 UBC LL Load Case(s)  
Plus 1 BC LL Load Case(s)  
Plus 1 DL Load Case(s)

Membr	CSI	P	Lbs	Ax1	CSI-Bnd
-----Top Chords-----					
A -F	0.26	1270	C	0.01	0.25
F -B	0.26	1173	C	0.01	0.25
B -G	0.25	1170	C	0.01	0.24
G -C	0.25	1268	C	0.01	0.24
-----Bottom Chords-----					

MiTek® Online Plus™ APPROX. TRUSS WEIGHT. 136 4 LBS

A -E	0.56	1058	T	0.21	0.35
E -D	0.65	685	T	0.14	0.51
D -C	0.55	1056	T	0.21	0.34
-----Webs-----					
F -E	0.07	276	C		
E -B	0.12	575	T		
B -D	0.12	571	T		
D -G	0.07	276	C		

TL Defl -0.21" in E -D L/999  
LL Defl -0.10" in E -D L/999  
Shear // Grain in E -D 0.19

Plates for each ply each face.  
Plate - MT20 20 Ga, Gross Area  
Plate - MT2H 20 Ga, Gross Area  
Jt Type Plt Size X Y JSI  
A MT20 3.0x 4.0 Ctr Ctr 0.74  
F MT20 2.0x 4.0 Ctr Ctr 0.29  
B MT20 4.0x 4.0 Ctr Ctr 0.71  
G MT20 2.0x 4.0 Ctr Ctr 0.29  
C MT20 3.0x 4.0 Ctr Ctr 0.74  
E MT20 3.0x 4.0 Ctr Ctr 0.44  
D MT20 4.0x 6.0-0.5-1.0 0.93

REVIEWED BY:  
MiTek Industries, Inc.  
6904 Parke East Blvd.  
Tampa, FL 33610

REFER TO ONLINE PLUS GENERAL NOTES AND SYMBOLS SHEET FOR ADDITIONAL SPECIFICATIONS.

NOTES:  
Trusses Manufactured by:  
Mayo Truss Co. Inc.  
Analysis Conforms To:  
FBC2010  
TPI 2007  
OH Loading  
Soffit psf 2.0  
This truss has been designed for 20.0 psf LL on the B.C. in areas where a rectangle 3- 6- 0 tall by 2- 0- 0 wide will fit between the B.C. and any other member.  
Design checked for 10 psf non-

concurrent LL on BC.  
Wind Loads - ANSI / ASCE 7-10  
Truss is designed as Components and Claddings\* for Exterior zone location.  
Wind Speed: 120 mph  
Risk Category : II  
Mean Roof Height: 15-0  
Exposure Category: B  
Building Type: Enclosed  
TC Dead Load: 6.0 psf  
BC Dead Load: 6.0 psf  
Max comp. force 1270 Lbs  
Max tens. force 1058 Lbs  
Connector Plate Fabrication Tolerance = 20%  
This truss is designed for a creep factor of 1.5 which is used to calculate total load deflection.

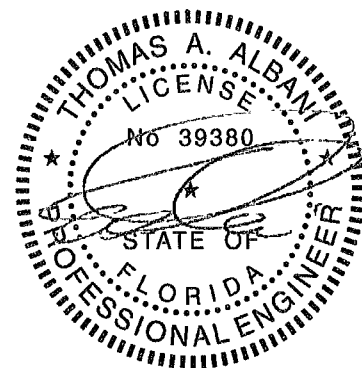

FL Cert. 6634

April 25, 2014

Job <b>INN-CG-1302</b>	Mark <b>B3GE</b>	Quan 1	Type TR	Span 210400	P1-H1 8	Left OH 1- 6- 0	Right OH 1- 6- 0	Engineering <b>T6277974</b>
---------------------------	---------------------	-----------	------------	----------------	------------	--------------------	---------------------	--------------------------------

COTTAGE GROVE MODEL 1302

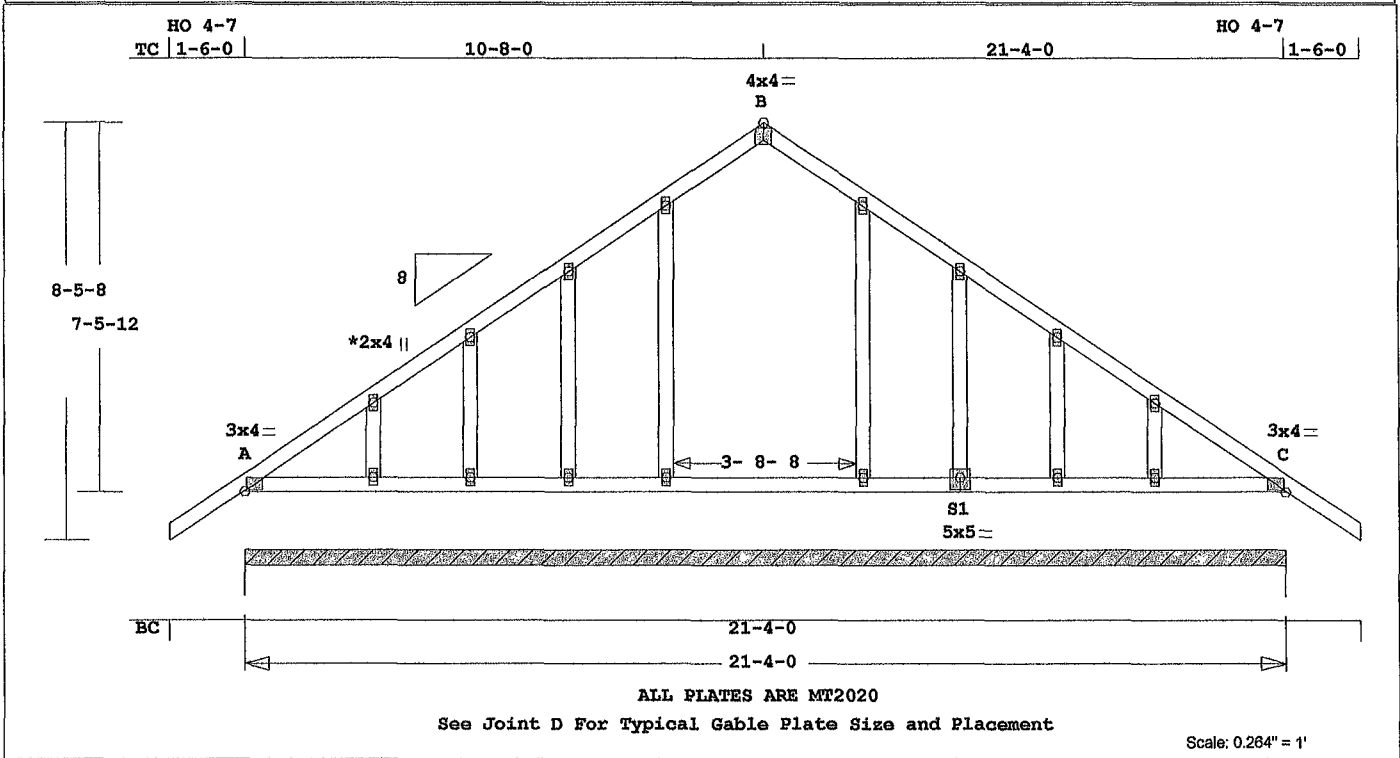

Online Plus -- Version 30 0.023  
RUN DATE: 25-APR-14

Southern Pine lumber design values are those effective 06-01-13 by SPIB//ALSC UON  
CSI -Size- ---Lumber---  
TC 0 05 2x 4 SP-#2  
BC 0 07 2x 4 SP-#2  
GW 0 09 2x 4 SP-#2

Brace truss as follows:  
O C. From To  
TC Cont. 0- 0- 0 21- 4- 0  
or 48.0" 0- 0- 0 21- 4- 0  
BC Cont. 0- 0- 0 21- 4- 0  
or 120.0" 0- 0- 0 21- 4- 0

psf-Ld Dead Live  
TC 10 0 20.0  
BC 10 0 0 0  
TC+BC 20.0 20.0  
Total 40.0 Spacing 24.0"  
Lumber Duration Factor 1.25  
Plate Duration Factor 1.25  
Fb Fc Ft Emin  
TC 1.15 1.10 1.10 1.10  
BC 1.10 1.10 1.10 1.10

Total Load Reactions (Lbs)  
Jt Down Uplift Horiz-  
A 1899 108 R

Jt Brg Size Required  
A 256.0" 0"-to- 256"

Plus 21 Wind Load Case(s)  
Plus 1 UBC LL Load Case(s)  
Plus 1 DL Load Case(s)

Membr	CSI	P	Lbs	Ax1	CSI-Bnd
---Top Chords---					
A -D	0 05	177	C	0.00	0 05
D -F	0 05	119	C	0.00	0 05
F -H	0 03	103	C	0.00	0 03
H -J	0 04	96	C	0.00	0 04
J -B	0 04	102	C	0.00	0 04
B -M	0 04	102	C	0.00	0 04
M -O	0 04	96	C	0.00	0 04
O -Q	0 03	103	C	0.00	0 03
Q -S	0 05	119	C	0.00	0 05
S -C	0 05	177	C	0.00	0 05
---Bottom Chords---					
A -E	0 03	3	T	0.00	0 03
E -G	0 03	0	T	0.00	0 03
G -I	0 02	0	T	0.00	0 02
I -K	0 07	0	T	0.00	0 07
K -N	0 07	0	T	0.00	0 07
N -S1	0 07	0	T	0.00	0 07
S1 -R	0 02	0	T	0.00	0 02

MiTek® Online Plus™ APPROX TRUSS WEIGHT 150 7 LBS

R -T	0 03	0	T	0.00	0 03
T -C	0 03	3	T	0.00	0 03
-----Gable Webs-----					
E -D	0 01	142	C		
G -F	0 02	115	C		
I -H	0 05	118	C		
K -J	0 09	128	C		
N -M	0 09	128	C		
S1 -O	0 05	118	C		
R -Q	0 02	115	C		
T -S	0 01	142	C		

TL Defl -0 01" in K -N L/999  
LL Defl -0 01" in K -N L/999  
Shear // Grain in A -D 0.08

Plates for each ply each face  
Plate - MT20 20 Ga, Gross Area  
Plate - MT2H 20 Ga, Gross Area

Jt Type	Plt Size	X	Y	JSI
A	MT20	3.0x 4.0	Ctr Ctr	0.49
D	MT20	2.0x 4.0	Ctr Ctr	0.00
F	MT20	2.0x 4.0	Ctr Ctr	0.00
H	MT20	2.0x 4.0	Ctr Ctr	0.00
J	MT20	2.0x 4.0	Ctr Ctr	0.00
B	MT20	4.0x 4.0	Ctr-1.2	0.33
M	MT20	2.0x 4.0	Ctr Ctr	0.00
O	MT20	2.0x 4.0	Ctr Ctr	0.00
Q	MT20	2.0x 4.0	Ctr Ctr	0.00
S	MT20	2.0x 4.0	Ctr Ctr	0.00
C	MT20	3.0x 4.0	Ctr Ctr	0.49
E	MT20	2.0x 4.0	Ctr Ctr	0.00
G	MT20	2.0x 4.0	Ctr Ctr	0.00
I	MT20	2.0x 4.0	Ctr Ctr	0.00
K	MT20	2.0x 4.0	Ctr Ctr	0.00
N	MT20	2.0x 4.0	Ctr Ctr	0.00
S1	MT20	5.0x 5.0	Ctr-0.5	0.39
R	MT20	2.0x 4.0	Ctr Ctr	0.00
T	MT20	2.0x 4.0	Ctr Ctr	0.00

REVIEWED BY:  
MiTek Industries, Inc.  
6904 Parke East Blvd  
Tampa, FL 33610

REFER TO ONLINE PLUS GENERAL NOTES AND SYMBOLS SHEET FOR ADDITIONAL SPECIFICATIONS.

NOTES:  
Trusses Manufactured by:  
Mayo Truss Co, Inc.  
Analysis Conforms To:  
FBC2010  
TPI 2007  
OH Loading  
Soffit psf 2.0  
Design checked for 10 psf non-concurrent LL on BC.  
Truss designed for wind loads

in the plane of the truss only For studs exposed to wind (normal to the face), see Standard Industry Gable End Details as applicable, or consult qualified Building Designer as per ANSI/TPI 1.  
Wind Loads - ANSI / ASCE 7-10  
Truss is designed as Components and Claddings\* for Exterior zone location  
Wind Speed: 120 mph  
Risk Category : II  
Mean Roof Height: 15-0  
Exposure Category B  
Building Type Enclosed  
TC Dead Load 6.0 psf  
BC Dead Load 6.0 psf  
Max comp. force 177 Lbs  
Max tens force 103 Lbs  
Connector Plate Fabrication Tolerance = 20%  
This truss is designed for a creep factor of 1.5 which is used to calculate total load deflection.

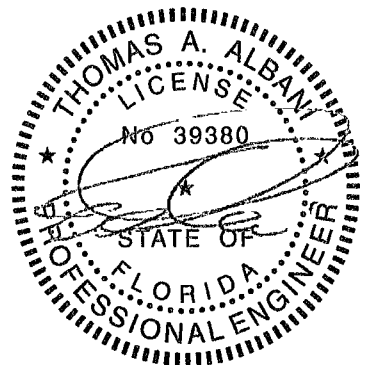

FL Cert. 6634

April 25, 2014

Job <b>INN-CG-1302</b>	Mark <b>CJI</b>	Quan 1	Type MONO.DD	Span 80513	P1-H1 5.657	Left OH 2- 1- 7	Right OH 0	Engineering T6277975
---------------------------	--------------------	-----------	-----------------	---------------	----------------	--------------------	---------------	-------------------------

COTTAGE GROVE MODEL 1302

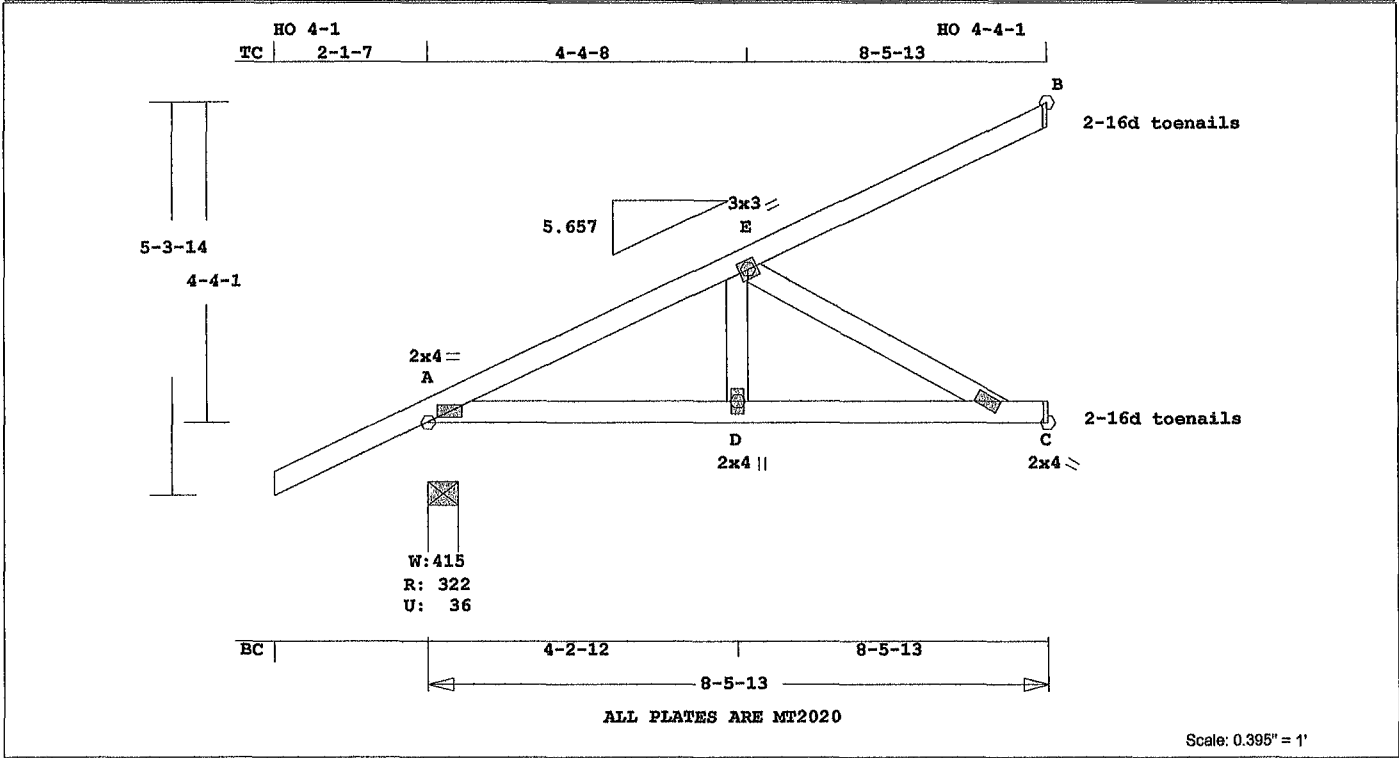

Online Plus -- Version 30.0.023  
RUN DATE: 25-APR-14

Southern Pine lumber design values are those effective 06-01-13 by SPIB//ALSC UON

CSI	-Size-	Lumber
TC	0.35 2x 4	SP-#2
BC	0.36 2x 4	SP-#2
WB	0.13 2x 4	SP-#2

Brace truss as follows:

O.C	From	To
TC Cont.	0- 0- 0	8- 4- 5
or	48.0"	0- 0- 0 8- 4- 5
BC Cont.	0- 0- 0	8- 4- 5
or	94.3"	0- 0- 0 8- 4- 5

psf-Ld	Dead	Live	
TC	10.0	20.0	
BC	10.0	0.0	
TC+BC	20.0	20.0	
Total	40.0	Spacing 24.0"	
Lumber Duration Factor	1.25		
Plate Duration Factor	1.25		
Fb	Fc	Ft	Emin
TC	1.00	1.00	1.00
BC	1.00	1.00	1.00

Total Load Reactions (Lbs)

Jt	Down	Uplift	Horiz-
A	322	37 U	78 R
C	239	36 U	
B	173	41 U	53 R

Jt	Brg Size	Required
A	4.9"	1.5"
C	1.5"	1.5"
B	1.5"	1.5"

LC# 1 Girder Loading

Dur	Fctrs	- Lbr	1.25	Plt	1.25
plf	- Dead	Live*	From	To	
TC V	20	40	0.0'	8.5'	
BC V	20	0	0.0'	8.5'	
TC V	-20	-40	0.0'	8.5'	
	15	31			
BC V	-20	0	0.0'	8.5'	
	15	0			

Plus 15 Wind Load Case(s)  
Plus 1 UBC LL Load Case(s)  
Plus 1 DL Load Case(s)

MiTek® Online Plus™ APPROX. TRUSS WEIGHT 49.4 LBS

Membr	CSI	P Lbs	Axl	CSI-End
-----Top Chords-----				
A -E	0.20	379 C	0.05	0.15
E -B	0.35	97 C	0.00	0.35
-----Bottom Chords-----				
A -D	0.18	449 C	0.05	0.13
D -C	0.36	449 C	0.08	0.28
C -C	0.23	0 T	0.00	0.23
-----Webs-----				
D -E	0.03	233 C		
E -C	0.13	512 T		

TL Defl -0.07" in D -C L/999  
LL Defl -0.03" in D -C L/999  
Shear // Grain in C -C 0.29

Plates for each ply each face.  
Plate - MT20 20 Ga, Gross Area  
Plate - MT2H 20 Ga, Gross Area  
Jt Type Plt Size X Y JSI  
A MT20 2.0x 4.0 Ctr Ctr 0.66  
E MT20 3.0x 3.0 Ctr Ctr 0.34  
D MT20 2.0x 4.0 Ctr Ctr 0.18  
C MT20 2.0x 4.0 Ctr Ctr 0.34

REVIEWED BY:  
MiTek Industries, Inc.  
6904 Parke East Blvd.  
Tampa, FL 33610

REFER TO ONLINE PLUS GENERAL NOTES AND SYMBOLS SHEET FOR ADDITIONAL SPECIFICATIONS.

For proper installation of toe-nails, refer to the 2005 National Design Specification (NDS) for Wood Construction

NOTES:  
Trusses Manufactured by: Mayo Truss Co. Inc.  
Analysis Conforms To: FBC2010 TPI 2007  
Girder King Jack Loading TC and BC Setback 6- 0- 0  
OH Loading Soffit psf 2.0  
Design checked for 10 psf non-concurrent LL on BC.

Use properly rated hangers for loads framing into girder truss.  
Wind Loads - ANSI / ASCE 7-10  
Truss is designed as Components and Claddings\* for Exterior zone location.  
Wind Speed: 120 mph  
Risk Category : II  
Mean Roof Height: 15-0  
Exposure Category: B  
Building Type: Enclosed  
TC Dead Load: 6.0 psf  
BC Dead Load: 6.0 psf  
User-defined wind-exposed BC regions --From-- --To--  
0- 0- 0 8- 5-13  
Max comp. force 449 Lbs  
Max tens. force 512 Lbs  
Connector Plate Fabrication Tolerance = 20%  
This truss is designed for a creep factor of 1.5 which is used to calculate total load deflection.

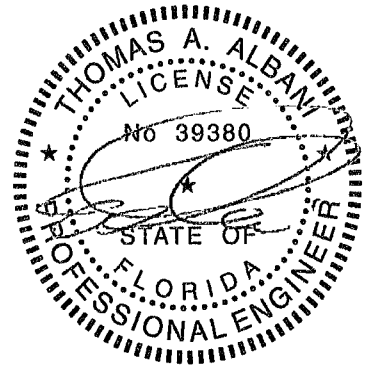

FL Cert. 6634

April 25, 2014

Job <b>INN-CG-1302</b>	Mark <b>CJ2</b>	Quan 2	Type MONO.DD	Span 70703	P1-H1 5.657	Left OH 2- 1- 7	Right OH 0	Engineering T6277976
---------------------------	--------------------	-----------	-----------------	---------------	----------------	--------------------	---------------	-------------------------

COTTAGE GROVE MODEL 1302

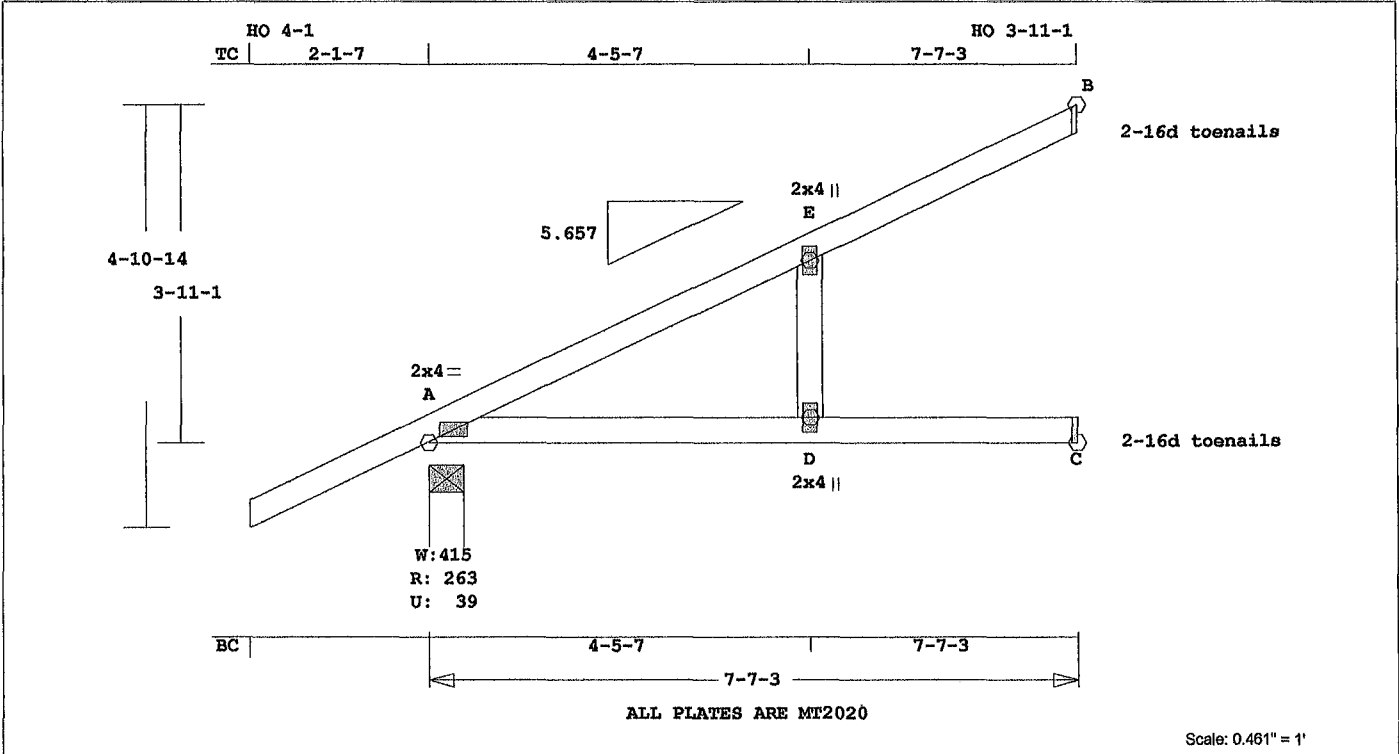

MiTek® Online Plus™ APPROX. TRUSS WEIGHT: 38.5 LBS

Online Plus -- Version 30.0.023  
RUN DATE: 25-APR-14

Southern Pine lumber design values are those effective 06-01-13 by SPIB//ALSC UON

CSI	Size	Lumber
TC	0.60 2x 4	SP-#2
BC	0.67 2x 4	SP-#2
WB	0.01 2x 4	SP-#2

Brace truss as follows:

O.C	From	To
TC Cont.	0- 0- 0	7- 3-11
or	48 0"	0- 0- 0 7- 3-11
BC Cont.	0- 0- 0	7- 3-11
or	91.2"	0- 0- 0 7- 3-11

psf-Ld	Dead	Live	
TC	10.0	20.0	
BC	10.0	0.0	
TC+BC	20.0	20.0	
Total	40.0	Spacing 24.0"	
Lumber Duration Factor	1.25		
Plate Duration Factor	1.25		
Fb	Fc	Ft	Emin
TC	1.00	1.00	1.00
BC	1.00	1.00	1.00

Total Load Reactions (Lbs)

Jt	Down	Uplift	Horiz-
A	263	39 U	61 R
C	140	19 U	
B	189	48 U	41 R

Jt	Brg Size	Required
A	4.9"	1.5"
C	3.5"	1.5"
B	1.5"	1.5"

LC#	1	Girder Loading
Dur	Fctrs	- Lbr 1.25 Plt 1.25
plf	- Dead	Live* From To
TC V	20	40 0.0' 7.6'
BC V	20	0 0.0' 7.6'
TC V	-20	-40 0.0' 7.6'
	11	22
BC V	-20	0 0.0' 7.6'
	11	0

Plus 15 Wind Load Case(s)  
Plus 1 UBC LL Load Case(s)  
Plus 1 DL Load Case(s)

Membr	CSI	P	Lbs	Ax1	CSI-Bnd
-----Top Chords-----					
A	-E	0.60	143 C	0.00	0.60
E	-B	0.60	119 C	0.00	0.60
-----Bottom Chords-----					
A	-D	0.67	0 T	0.00	0.67
D	-C	0.63	0 T	0.00	0.63
-----Webs-----					
D	-E	0.01	143 C	WindLd	
TL Defl	-0.34" in A -D L/239				
LL Defl	-0.14" in A -D L/595				
Hz Disp	LL	DL	TL		
Jt B	0.02"	0.01"	0.02"		
Shear // Grain	in E -B 0.22				

Plates for each ply each face.  
Plate - MT20 20 Ga, Gross Area  
Plate - MT2H 20 Ga, Gross Area  
Jt Type Plt Size X Y JSI  
A MT20 2.0x 4.0 Ctr Ctr 0.66  
E MT20 2.0x 4.0 Ctr Ctr 0.13  
D MT20 2.0x 4.0 Ctr Ctr 0.12

REVIEWED BY:  
MiTek Industries, Inc.  
6904 Parke East Blvd.  
Tampa, FL 33610

REFER TO ONLINE PLUS GENERAL NOTES AND SYMBOLS SHEET FOR ADDITIONAL SPECIFICATIONS.

For proper installation of toe-nails, refer to the 2005 National Design Specification (NDS) for Wood Construction

NOTES:  
Trusses Manufactured by:  
Mayo Truss Co. Inc.  
Analysis Conforms To:  
FBC2010  
TPI 2007  
Girder King Jack  
Loading TC and BC  
Setback 5- 4- 8  
OH Loading  
Soffit psf 2.0  
Design checked for 10 psf non-concurrent LL on BC.  
Use properly rated hangers for

loads framing into girder truss.  
Wind Loads - ANSI / ASCE 7-10  
Truss is designed as Components and Claddings\* for Exterior zone location.  
Wind Speed: 120 mph  
Risk Category II  
Mean Roof Height: 15-0  
Exposure Category: B  
Building Type: Enclosed  
TC Dead Load: 6.0 psf  
BC Dead Load: 6.0 psf  
User-defined wind-exposed BC regions --From-- --To--  
0- 0- 0 7- 7- 3  
Max comp. force 143 lbs  
Max tens. force 46 lbs  
Connector Plate Fabrication  
Tolerance = 20%  
This truss is designed for a creep factor of 1.5 which is used to calculate total load deflection.

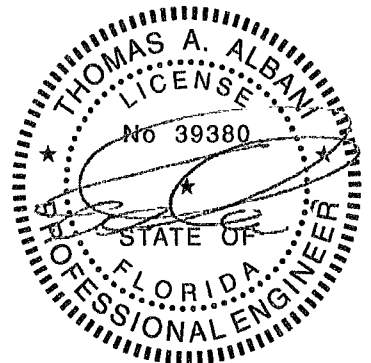

FL Cert. 6634

April 25, 2014

Job <b>INN-CG-1302</b>	Mark <b>J1</b>	Quan 5	Type JCA2	Span 60000	P1-H1 8	Left OH 1- 6- 0	Right OH 0	Engineering <b>T6277977</b>
---------------------------	-------------------	-----------	--------------	---------------	------------	--------------------	---------------	--------------------------------

COTTAGE GROVE MODEL 1302

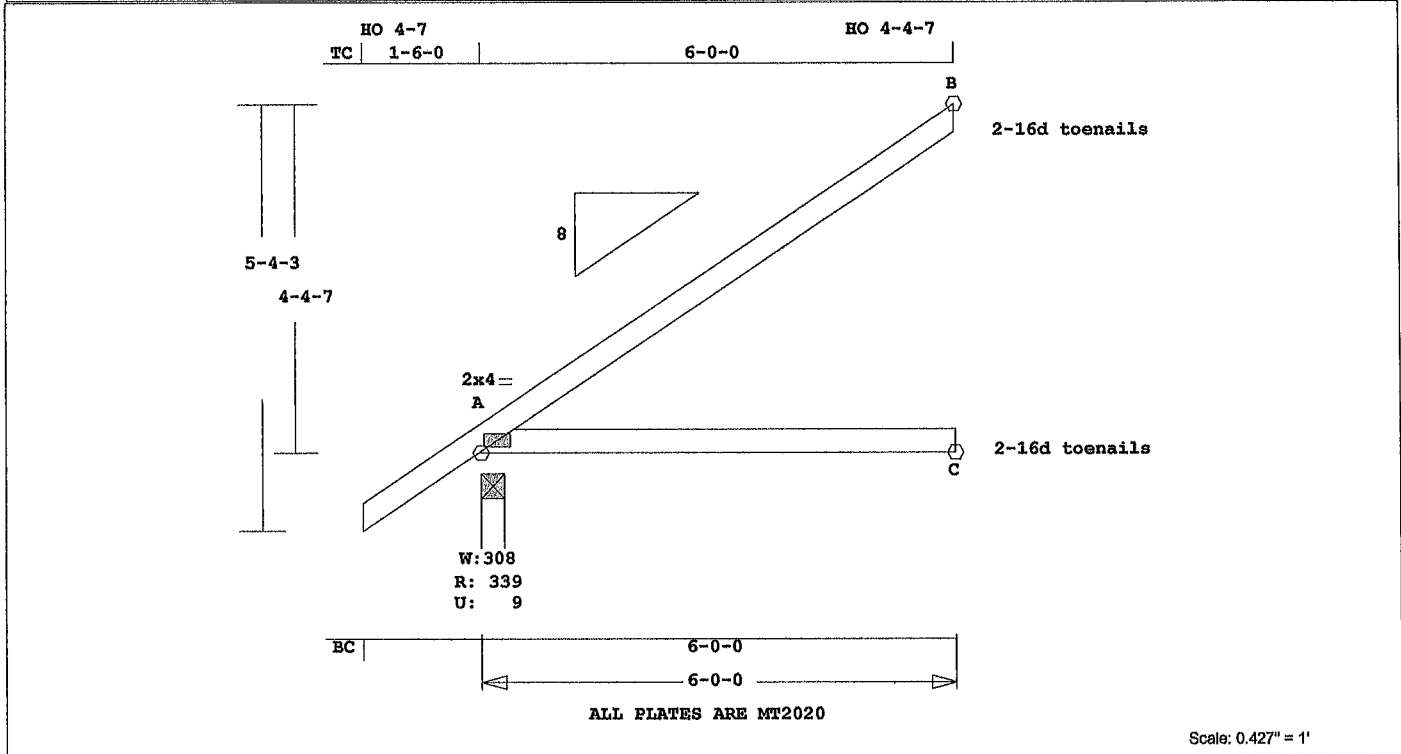

Online Plus -- Version 30.0.023  
RUN DATE: 25-APR-14

Southern Pine lumber design values are those effective 06-01-13 by SPIB//ALSC UON  
CSI -Size- ---Lumber---  
TC 0.51 2x 4 SP-#2  
BC 0.45 2x 4 SP-#2

Brace truss as follows:

O.C.	From	To
TC Cont.	0- 0- 0	6- 0- 0
or 48.0"	0- 0- 0	6- 0- 0
BC Cont.	0- 0- 0	6- 0- 0
or 72.0"	0- 0- 0	6- 0- 0

psf-I'd	Dead	Live		
TC	10.0	20.0		
BC	10.0	0.0		
TC+BC	20.0	20.0		
Total	40.0	24.0"		
Lumber	Duration Factor	1.25		
Plate	Duration Factor	1.25		
	Fb	Fc	Ft	Emin
TC	1.15	1.10	1.10	1.10
BC	1.10	1.10	1.10	1.10

Total Load Reactions (Lbs)

Jt	Down	Uplift	Horiz-
A	339	10 U	87 R
C	114	16 U	
B	160	53 U	59 R

Jt	Brg Size	Required
A	3.5"	1.5"
C	3.5"	1.5"
B	1.5"	1.5"

Plus 18 Wind Load Case(s)  
Plus 1 UBC LL Load Case(s)  
Plus 1 DL Load Case(s)

Membr CSI P Lbs Ax1-CSI-Bnd

-----Top Chords-----	A	-B	0.51	87 C	0.00	0.51
-----Bottom Chords-----						

MiTek® Online Plus™ APPROX TRUSS WEIGHT, 28.7 LBS  
A -C 0.45 0 T 0.00 0.45

TL Defl -0.11" in A -C L/572  
LL Defl -0.05" in A -C L/999  
Shear // Grain in A -B 0.19

Plates for each ply each face.  
Plate - MT20 20 Ga, Gross Area  
Plate - MT2H 20 Ga, Gross Area  
Jt Type Plt Size X Y JSI  
A MT20 2.0x 4.0 Ctr Ctr 0.59

REVIEWED BY:  
MiTek Industries, Inc.  
6904 Parke East Blvd.  
Tampa, FL 33610

REFER TO ONLINE PLUS GENERAL NOTES AND SYMBOLS SHEET FOR ADDITIONAL SPECIFICATIONS.

For proper installation of toe-nails, refer to the 2005 National Design Specification (NDS) for Wood Construction

NOTES:  
Trusses Manufactured by:  
Mayo Truss Co. Inc.  
Analysis Conforms To:  
FBC2010  
TPI 2007  
OH Loading  
Soffit psf 2.0

This truss has been designed for 20.0 psf LL on the B.C. in areas where a rectangle 3- 6- 0 tall by 2- 0- 0 wide will fit between the B.C. and any other member.

Design checked for 10 psf non-concurrent LL on BC.  
Wind Loads - ANSI / ASCE 7-10  
Truss is designed as Components and Claddings\* for Exterior zone location.

Wind Speed: 120 mph  
Risk Category : II  
Mean Roof Height: 15-0  
Exposure Category: B  
Building Type: Enclosed  
TC Dead Load: 6.0 psf  
BC Dead Load: 6.0 psf  
User-defined wind-exposed BC regions --From-- ---To---  
0- 0- 0 6- 0- 0  
Max comp. force 87 Lbs  
Max tens. force 45 Lbs  
Connector Plate Fabrication  
Tolerance = 20%  
This truss is designed for a creep factor of 1.5 which is used to calculate total load deflection.

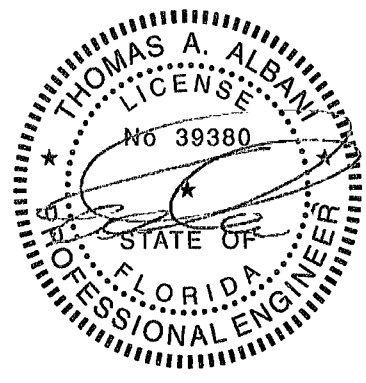

FL Cert. 6634



Job <b>INN-CG-1302</b>	Mark <b>J2</b>	Quan 6	Type JCA2	Span 50000	Pl-H1 8	Left OH 1- 6- 0	Right OH 0	Engineering T6277979
---------------------------	-------------------	-----------	--------------	---------------	------------	--------------------	---------------	-------------------------

COTTAGE GROVE MODEL 1302

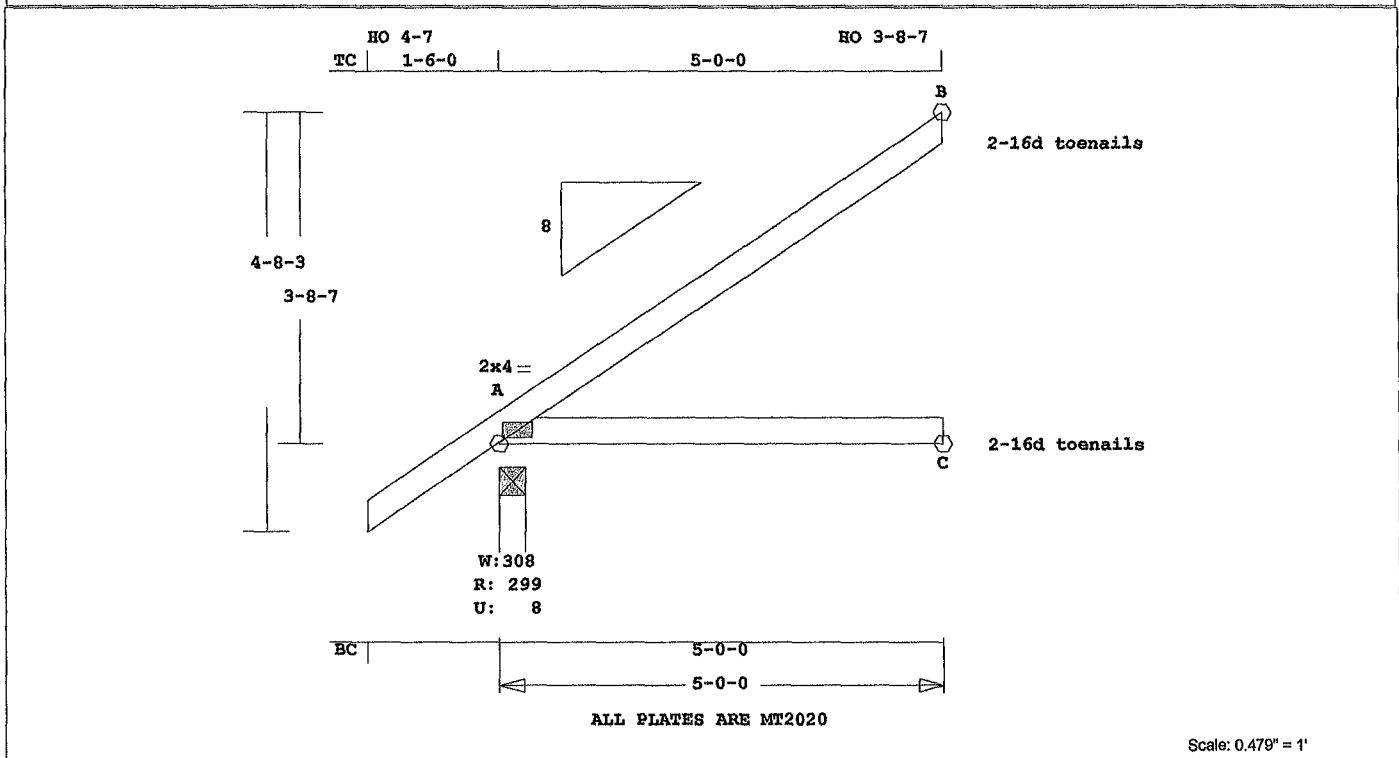

Online Plus -- Version 30.0.023  
RUN DATE: 25-APR-14

Southern Pine lumber design values are those effective  
06-01-13 by SPIB//ALSC UON  
CSI -Size- ----Lumber----  
TC 0.32 2x 4 SP-#2  
BC 0.31 2x 4 SP-#2

Brace truss as follows:  
O.C. From To  
TC Cont. 0- 0- 0 5- 0- 0  
or 48.0" 0- 0- 0 5- 0- 0  
BC Cont. 0- 0- 0 5- 0- 0  
or 60.0" 0- 0- 0 5- 0- 0

psf-ld	Dead	Live
TC	10.0	20.0
BC	10.0	0.0
TC+BC	20.0	20.0
Total	40.0	Spacing 24.0"
Lumber	Duration	Factor 1.25
Plate	Duration	Factor 1.25
	Fb	Fc Ft Emin
TC	1.15	1.10 1.10 1.10
BC	1.10	1.10 1.10 1.10

Total Load Reactions (Lbs)  
Jt Down Uplift Horiz-  
A 300 9 U 73 R  
C 95 14 U  
B 133 44 U 49 R

Jt	Brg Size	Required
A	3.5"	1.5"
C	3.5"	1.5"
B	1.5"	1.5"

Plus 18 Wind Load Case(s)  
Plus 1 UBC LL Load Case(s)  
Plus 1 DL Load Case(s)

Membr	CSI	P	Lbs	Axl-CSI-Bnd
-----Top Chords-----				
A -B	0.32	74	C	0.01 0.31
-----Bottom Chords-----				

MiTek® Online Plus™ APPROX. TRUSS WEIGHT, 24.6 LBS  
A -C 0.31 0 T 0.00 0.31

TL Defl -0.05" in A -C L/999  
LL Defl -0.02" in A -C L/999  
Shear // Grain in A -C 0.17  
  
Plates for each ply each face.  
Plate - MT20 20 Ga, Gross Area  
Plate - MT2H 20 Ga, Gross Area  
Jt Type Plt Size X Y JSI  
A MT20 2.0x 4.0 Ctr Ctr 0.59

REVIEWED BY:  
MiTek Industries, Inc.  
6904 Parke East Blvd.  
Tampa, FL 33610

REFER TO ONLINE PLUS GENERAL NOTES AND SYMBOLS SHEET FOR ADDITIONAL SPECIFICATIONS.

For proper installation of toe-nails, refer to the 2005 National Design Specification (NDS) for Wood Construction

NOTES:  
Trusses Manufactured by:  
Mayo Truss Co. Inc.  
Analysis Conforms To:  
FBC2010  
TPI 2007  
OH Loading  
Soffit psf 2.0  
This truss has been designed for 20.0 psf LL on the B.C. in areas where a rectangle 3- 6- 0 tall by 2- 0- 0 wide will fit between the B.C. and any other member.  
Design checked for 10 psf non-concurrent LL on BC.  
Wind Loads - ANSI / ASCE 7-10  
Truss is designed as Components and Claddings\* for Exterior zone location.

Wind Speed: 120 mph  
Risk Category : II  
Mean Roof Height: 15-0  
Exposure Category: B  
Building Type: Enclosed  
TC Dead Load: 6.0 psf  
BC Dead Load: 6.0 psf  
User-defined wind-exposed BC regions --From-- --To---  
0- 0- 0 5- 0- 0  
Max comp. force 74 Lbs  
Max tens. force 38 Lbs  
Connector Plate Fabrication Tolerance = 20%  
This truss is designed for a creep factor of 1.5 which is used to calculate total load deflection.

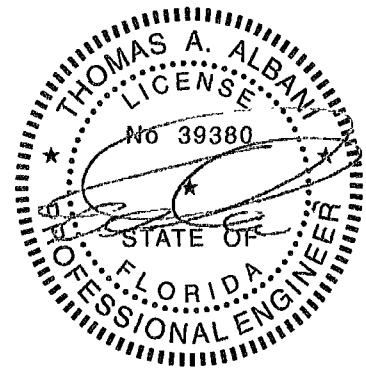

FL Cert. 6634

April 25, 2014

Job <b>INN-CG-1302</b>	Mark <b>J3</b>	Quan 6	Type JCA2	Span 30000	P1-H1 8	Left OH 1- 6- 0	Right OH 0	Engineering T6277980
---------------------------	-------------------	-----------	--------------	---------------	------------	--------------------	---------------	-------------------------

COTTAGE GROVE MODEL 1302

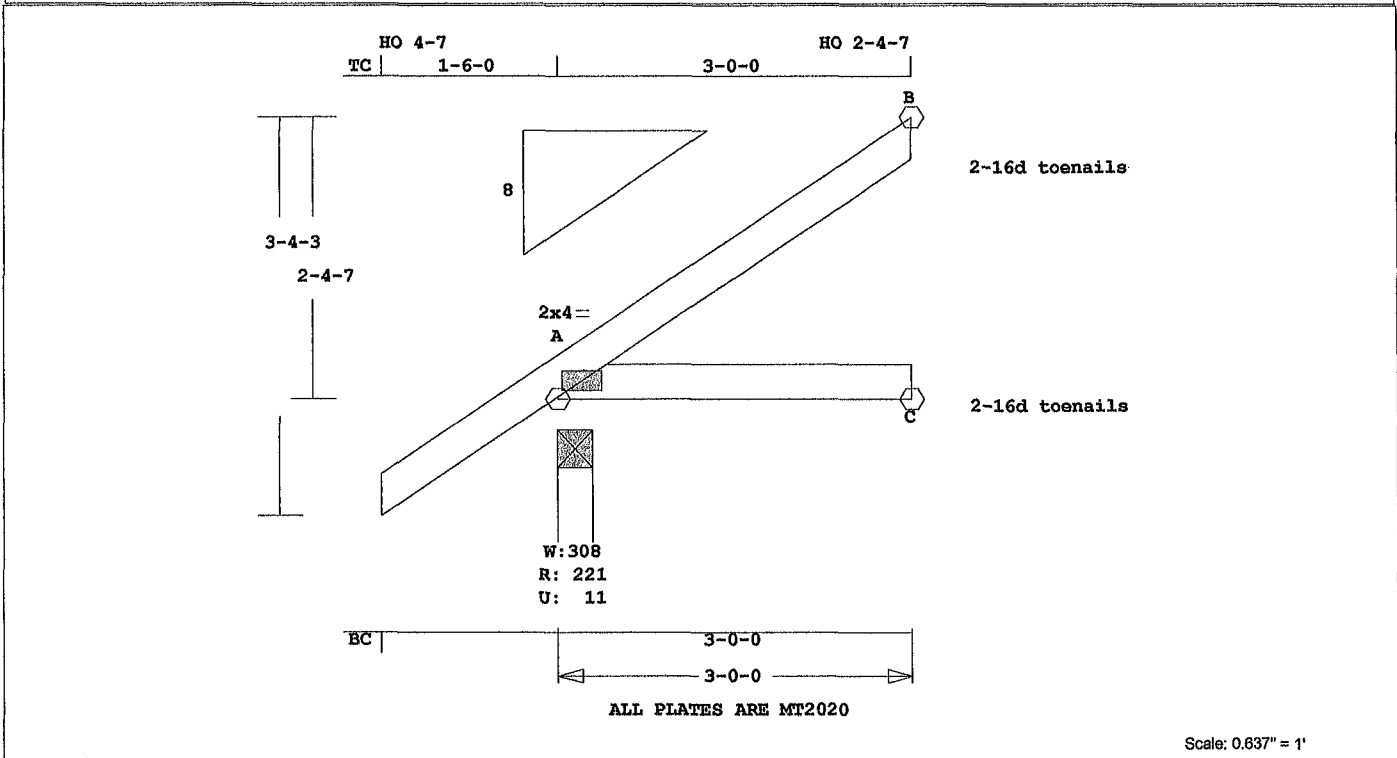

Scale: 0.837" = 1'

MiTek® Online Plus™ APPROX TRUSS WEIGHT 16.3 LBS

Online Plus -- Version 30.0.023  
RUN DATE: 25-APR-14

Southern Pine lumber design values are those effective 06-01-13 by SPIB//ALSC UON

CSI -Size- ----Lumber----  
TC 0.09 2x 4 SP-#2  
BC 0.09 2x 4 SP-#2

Brace truss as follows:

O.C.	From	To
TC Cont.	0- 0- 0	3- 0- 0
or 36.0"	0- 0- 0	3- 0- 0
BC Cont.	0- 0- 0	3- 0- 0
or 36.0"	0- 0- 0	3- 0- 0

psf-Ld	Dead	Live		
TC	10.0	20.0		
BC	10.0	0.0		
TC+BC	20.0	20.0		
Total	40.0	Spacing 24.0"		
Lumber	Duration Factor	1.25		
Plate	Duration Factor	1.25		
	Fb	Fc	Ft	Emin
TC	1.15	1.10	1.10	1.10
BC	1.10	1.10	1.10	1.10

Total Load Reactions (Lbs)

Jt	Down	Uplift	Horiz-
A	222	11 U	44 R
C	56	9 U	
B	78	27 U	29 R

Jt	Brg Size	Required
A	3.5"	1.5"
C	3.5"	1.5"
B	1.5"	1.5"

Plus 18 Wind Load Case(s)  
Plus 1 UBC LL Load Case(s)  
Plus 1 DL Load Case(s)

Membr	CSI	P	Lbs	Axl	CSI-Bnd
-----Top Chords-----					
A -B	0.09	44	C	0.00	0.09
-----Bottom Chords-----					

A -C 0.09 0 T 0.00 0.09

TL Defl -0.01" in A -C L/999  
LL Defl 0.00" in A -C L/999  
Shear // Grain in A -C 0.09

Plates for each ply each face.  
Plate - MT20 20 Ga, Gross Area  
Plate - MT2H 20 Ga, Gross Area  
Jt Type Plt Size X Y JSI  
A MT20 2.0x 4.0 Ctr Ctr 0.59

REVIEWED BY:  
MiTek Industries, Inc.  
6904 Parke East Blvd.  
Tampa, FL 33610

REFER TO ONLINE PLUS GENERAL NOTES AND SYMBOLS SHEET FOR ADDITIONAL SPECIFICATIONS.

For proper installation of toe-nails, refer to the 2005 National Design Specification (NDS) for Wood Construction

NOTES:

Trusses Manufactured by:  
Mayo Truss Co. Inc.

Analysis Conforms To:

FBC2010

TPI 2007

OH Loading

Soffit psf 2.0

This truss has been designed for 20.0 psf LL on the B.C. in areas where a rectangle 3- 6- 0 tall by 2- 0- 0 wide will fit between the B.C. and any other member.

Design checked for 10 psf non-concurrent LL on BC.

Wind Loads - ANSI / ASCE 7-10  
Truss is designed as

Components and Claddings\*  
for Exterior zone location.

Wind Speed: 120 mph  
Risk Category : II  
Mean Roof Height: 15-0  
Exposure Category: B  
Building Type: Enclosed  
TC Dead Load: 6.0 psf  
BC Dead Load: 6.0 psf  
User-defined wind-exposed BC regions --From-- --To--  
0- 0- 0 3- 0- 0  
Max comp. force 44 Lbs  
Max tens. force 23 Lbs  
Connector Plate Fabrication  
Tolerance = 20%

This truss is designed for a creep factor of 1.5 which is used to calculate total load deflection.

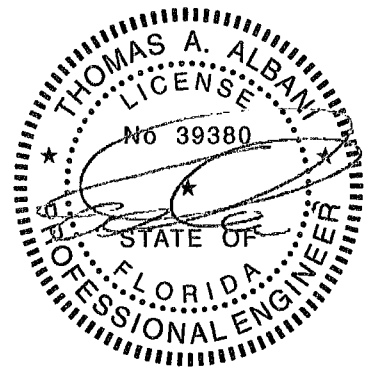

FL Cert. 6634

April 25, 2014

Job <b>INN-CG-1302</b>	Mark <b>J4</b>	Quan 6	Type JCA2	Span 10000	P1-H1 8	Left OH 1- 6- 0	Right OH 0	Engineering T6277981
---------------------------	-------------------	-----------	--------------	---------------	------------	--------------------	---------------	-------------------------

COTTAGE GROVE MODEL 1302

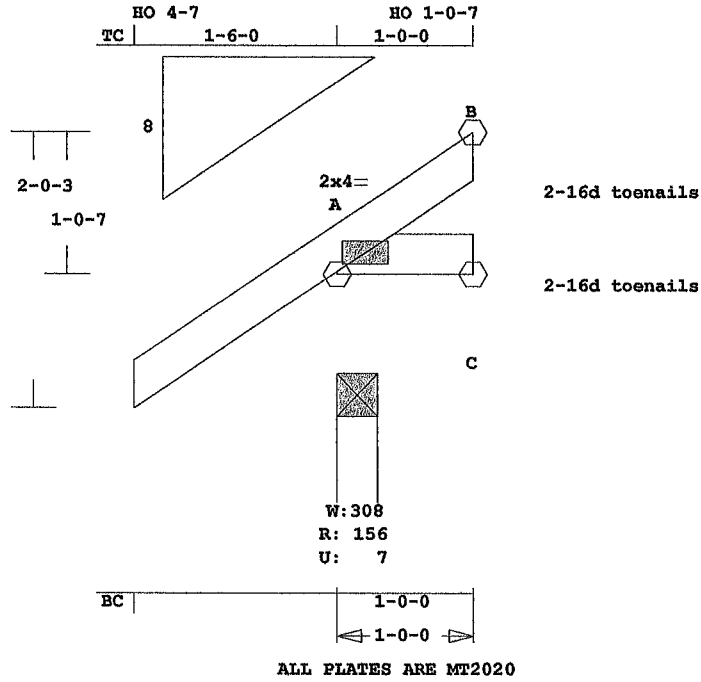

Scale: 0.732" = 1'

Online Plus -- Version 30.0.023  
RUN DATE: 25-APR-14

Southern Pine lumber design values are those effective 06-01-13 by SPIB//ALSC UON  
CSI -Size- ----Lumber-----  
TC 0.00 2x 4 SP-#2  
BC 0.00 2x 4 SP-#2

Brace truss as follows:  
O.C. From To  
TC Cont. 0- 0- 0 1- 0- 0  
or 12.0" 0- 0- 0 1- 0- 0  
BC Cont. 0- 0- 0 1- 0- 0  
or 12.0" 0- 0- 0 1- 0- 0

psf-Ld	Dead	Live		
TC	10.0	20.0		
BC	10.0	0.0		
TC+BC	20.0	20.0		
Total	40.0	Spacing 24.0"		
Lumber	Duration Factor	1.25		
Plate	Duration Factor	1.25		
	Fb	Fc	Ft	Emin
TC	1.15	1.10	1.10	1.10
BC	1.10	1.10	1.10	1.10

Total Load Reactions (Lbs)  
Jt Down Uplift Horiz-  
A 157 7 U 14 R  
B 24 10 U  
C 13 3 U 9 R

Jt	Brg Size	Required
A	3.5"	1.5"
B	1.5"	1.5"
C	1.5"	1.5"

Plus 18 Wind Load Case(s)  
Plus 1 UBC LL Load Case(s)  
Plus 1 DL Load Case(s)

Membr CSI P Lbs Axl-CSt-Bnd  
-----Top Chords-----  
A -B 0.00 12 C  
-----Bottom Chords-----

Mitek® Online Plus™ APPROX. TRUSS WEIGHT. 7 9 LBS  
A -C 0.00 9 T

TL Defl 0.00" in A -C L/999  
LL Defl 0.00" in A -C L/999  
Shear // Grain in A -B 0.02

Plates for each ply each face.  
Plate - MT20 20 Ga, Gross Area  
Plate - MT2H 20 Ga, Gross Area  
Jt Type Plt Size X Y JSI  
A MT20 2.0x 4.0 Ctr Ctr 0.59

REVIEWED BY:  
MiTek Industries, Inc.  
6904 Parke East Blvd.  
Tampa, FL 33610

REFER TO ONLINE PLUS GENERAL NOTES AND SYMBOLS SHEET FOR ADDITIONAL SPECIFICATIONS.

For proper installation of toe-nails, refer to the 2005 National Design Specification (NDS) for Wood Construction

NOTES:

Trusses Manufactured by:  
Mayo Truss Co. Inc.  
Analysis Conforms To:  
FBC2010  
TPI 2007

OH Loading  
Soffit psf 2.0

This truss has been designed for 20.0 psf LL on the B.C. in areas where a rectangle 3- 6- 0 tall by 2- 0- 0 wide will fit between the B.C. and any other member.

Design checked for 10 psf non-concurrent LL on BC.  
Wind Loads - ANSI / ASCE 7-10  
Truss is designed as Components and Claddings\* for Exterior zone location.

Wind Speed: 120 mph  
Risk Category : II  
Mean Roof Height: 15-0  
Exposure Category: B  
Building Type: Enclosed  
TC Dead Load: 6.0 psf  
BC Dead Load: 6.0 psf  
User-defined wind-exposed BC regions --From-- --To--  
0- 0- 0 1- 0- 0  
Max comp. force 12 Lbs  
Max tens. force 9 Lbs  
Connector Plate Fabrication  
Tolerance = 20%  
This truss is designed for a creep factor of 1.5 which is used to calculate total load deflection.

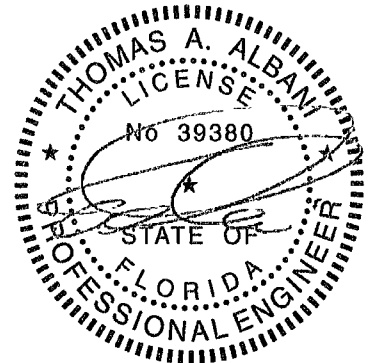

FL Cert. 6634

April 25, 2014

# ONLINE PLUS GENERAL NOTES & SYMBOLS

108

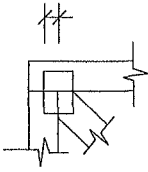

## PLATE LOCATION

Center plates on joints unless otherwise noted in plate list or on drawing. Dimensions are given in inches (i.e. 1 1/2" or 1.5") or IN-16ths (i.e. 108)

## FLOOR TRUSS SPLICE ( 3X2, 4X2, 6X2 )

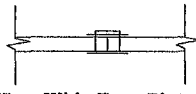

(W) = Wide Face Plate  
(N) = Narrow Face Plate

## LATERAL BRACING

Designates the location for continuous lateral bracing (CLB) for support of individual truss members only. CLBs must be properly anchored or restrained to prevent simultaneous buckling of adjacent truss members

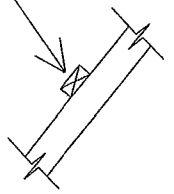

## PLATE SIZE AND ORIENTATION

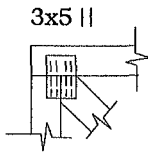

The first dimension is the width measured perpendicular to slots  
The second dimension is the length measured parallel to slots. Plate orientation, shown next to plate size, indicates direction of slots in connector plates

## DIMENSIONS

All dimensions are shown in FT-IN-SX (i.e. 6'-8.5" or 6-08-08) Dimensions less than one foot are shown in IN-SX only (i.e. 708).

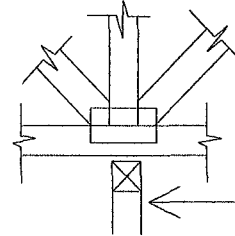
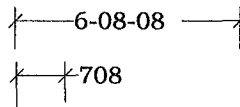

W = Actual Bearing Width (IN-SX)  
R = Reaction (lbs.)  
U = Uplift (lbs.)

## BEARING

When truss is designed to bear on multiple supports, interior bearing locations should be marked on the truss. Interior support or temporary shoring must be in place before trusses are installed. If necessary, shim bearings to assure solid contact with truss.

Metal connector plates shall be applied on both faces of truss at each joint. Center the plates, unless indicated otherwise. No loose knots or wane in plate contact area. Splice only where shown. Overall spans assume 4" bearing at each end, unless indicated otherwise. Cutting and fabrication shall be performed using equipment which produces snug-fitting joints and plates. Unless otherwise noted, moisture content of lumber shall not exceed 19% at time of fabrication and the attached truss designs are not applicable for use with fire retardant lumber and some preservative treatments. Nails specified on Truss Design Drawings refer to common wire nails, except as noted. The attached design drawings were prepared in accordance with " National Design Specifications for Wood Construction" (AF & PA ), " National Design Standard for Metal Plate Connected Wood Truss Construction" (ANSI/TPI 1), and HUD Design Criteria for Trussed Rafters.

Mitek Industries Inc. bears no responsibility for the erection of trusses, field bracing or permanent truss bracing. Refer to "Building Component Safety Information" (BCSI 1) as published by Truss Plate Institute, 218 North Lee Street, Suite 312, Alexandria, Virginia 22314. Persons erecting trusses are cautioned to seek professional advice concerning proper erection bracing to prevent toppling and " dominoing ". Care should be taken to prevent damage during fabrication, storage, shipping and erection. Top and bottom chords shall be adequately braced in the absence of sheathing or rigid ceiling, respectively. It is the responsibility of others to ascertain that design loads utilized on these drawings meet or exceed the actual dead loads imposed by the structure and the live loads imposed by the local building code or historical climatic records. When truss hangers are specified on the Truss Design Drawing, they must be installed per manufacturer's details and specifications.

FURNISH A COPY OF THE ATTACHED TRUSS DESIGN DRAWINGS TO ERECTION CONTRACTOR. IT IS THE RESPONSIBILITY OF THE BUILDING DESIGNER TO REVIEW THESE DRAWINGS AND VERIFY THAT DATA, INCLUDING DIMENSIONS & LOADS, CONFORM TO ARCHITECTURAL PLAN / SPECS AND THE TRUSS PLACEMENT DIAGRAM FURNISHED BY THE TRUSS MANUFACTURER.



**MiTek USA, Inc.**

6904 Parke East Blvd.  
Tampa, FL 33610-4115

Tel: 813-972-1135  
Fax: 813-971-6117