



Rib Roofing INSTALLATION MANUAL

629 SE Industrial Circle
Lake City, FL 32025
386-752-2950



TABLE OF CONTENTS

CAPITAL METAL SUPPLY

PRODUCT INFORMATION.....Page 3, 4

CAPITAL METAL SUPPLY FEATURES & DESCRIPTION Page 5

PANEL INSTALLATION.....Page 6

PANEL FASTENER APPLICATION..... Page 7

FRAME & PANEL FASTENER APPLICATION.....Page 8

ROOF INSTALLATION SEQUENCE.....Page 9

SINGLE ANGLE FASCIA.....Page 10

EAVE DRIP..... Page 11

PREFORMED VALLEY.....Page 12

HIP CAP.....Page 13

RIDGE CAP.....Page 14

ROOF PITCH TRANSITION.....Page 15

GABLE RAKE.....Page 15

SIDE WALL.....Page 17

END WALL.....Page 18

PIPE FLASHING.....Page 19

HARDWARE & ACCESSORIES.....Page 20, 21

TABLE of contents



PRODUCT INFORMATION

GENERAL

- A.** The main ribs on the Capital Metal Supply roofing panels are identical or symmetrical, with the exception of one of the outside edge ribs, so it is important that all of the panels are properly orientated in the same direction during the installation process. Although the panels may be erected from either direction the Capital Metal roofing panels cannot be reversed or turned end from end once installation has started. It is recommended that the overlapping seams between panels are oriented away from prevailing wind and rain directions.
- B.** Capital Metal Supply roofing panels are manufactured with a 36" nominal coverage. Use care in the installation process to prevent spreading of the panel width, which could detract from its appearance and may lead to problems with installation of the trim accessories.
- C.** Foot traffic should be limited on the panels to prevent any damage. This recommendation is augmented when panels are installed over purlins. If some foot traffic is necessary, boards or plywood strips should be placed over the panels.
- D.** Trim pieces should be end-lapped a minimum of six inches. A bead of gun grade sealant should be applied between the two pieces of metal to prevent weather penetration.

HANDLING

- A.** Capital Metal Supply recommends that panels be handled individually and on edge with one person every 10-15 feet. Panel buckling causing permanent deformation can occur if handled other than on edge.
- B.** Use extra care when handling skids of material with a forklift or similar lifting equipment to avoid damaging panels through the bottom of the skid. For skids over 20 feet it is recommended that a crane or spreader bar type assembly is used to prevent buckling or other permanent damage.
- C.** Do not drag panels onto the roof over the eave line from the ground level. This may cause panel buckling or other permanent damage.
- D.** Proper handling and storage of the Capital Metal Supply roofing panels, accessories and trim pieces are the responsibility of the installer or end user.

STORAGE

- A.** Material not used immediately should be stored in a dry place to minimize the possibility of exposure to any type of moisture. Moisture trapped between panels may result in water stains or white rust that could affect the service life of the material and detract from its appearance.
- B.** Capital Metal Supply recommends the banding material be removed and the material be stored in a slightly inclined position. Materials should be kept off the ground.
- C.** If indoor storage is not an option, protect the material with a canvas or water proof paper cover. Plastic or similar materials that can cause sweating or condensation should not be used. In addition to covering, keep the material off the ground in an inclined position with an insulator such as wood.



INSTALLATION TOOLS & EQUIPMENT

The following tools and equipment are suggested by Capital Metal Supply for the installation of Capital rib panels, trim and accessories. Some or all may be needed.

(Safety glasses, work gloves, carpenters hammer, tape measure, metal cutting scissors, chalk line, screw gun, staple gun, nail gun, electric saw with metal cutting blade, saw horses, electric drill, drill bits, carpenter square, angle finder, straight edge wax pencil)

METHODS TO INSTALL

ROOFING Side laps should face away from wind driven rain. Begin installing panels by laying the first sheet square with the eave, which is at the down end of the roof, farthest from the direction of prevailing winds. Allow an overhang of one inch minimum at the eave. At the gable edge, apply a standard rake trim or sidewall flashing if gable is against a wall. This guards against lifting in high winds and will provide a finished appearance. *Any roof with less than a 3/12 pitch will require butyl tape to be applied to the entire length of the panel overlap. Lap screws will also be required.

SIDING Use a standard fastening and overlap pattern for installing siding to insure proper panel performance. Use formed flashings for strong, neat corners. Do not run sheets all the way to the ground. Provide a protective base of concrete block, mortar, treated wood or similar material 12 to 18 inches from ground level and end the siding sheets there.

BENDING/BOWING Building panels are manufactured from extremely hard tempered metal. If a sheet must be bent, be cautious not to form the metal around too sharp a corner, a gentle 90 degree bend is the maximum recommended. Metal should not be re-bent once it has been formed, nor should it be folded back on itself.

FASTENING To assure a more positive seal use a screw with combination metal and neoprene washers. For steel building panels attaching to wood substrates, a plated wood grip screw should be used. For steel-building panels attaching to steel framed substrates, a plated self-drilling screw should be used. The correct way to fasten panels is to drive the screw into the panel so the sealing washer is compressed securely against the metal.

CUTTING PANELS A portable shear is recommended for across the panel profile cutting of galvanized steel. When cutting painted products, the sheet should be turned reverse side up in order that the metal particles and filings do not become embedded and cause rust marks on the face of the panel. In addition, all cut panels should be thoroughly brushed after installation to insure the removal of all-metal particles and filings.

BUILDING DESIGN AND CONSTRUCTION Metal panels must be protected from potentially corrosive situations and materials. Capital Metal Supply does not recommend that building panels be installed over green or damp lumber. However, if installing over green or damp lumber, a positive vapor barrier must be installed to separate the panels from the wood. Fertilizer, lime, acids, feeds, manure and soils also have the potential to initiate corrosion in a metal panel.

AN OVERVIEW OF TRIM DISCRPTION AND INSTALLATION LOCATION

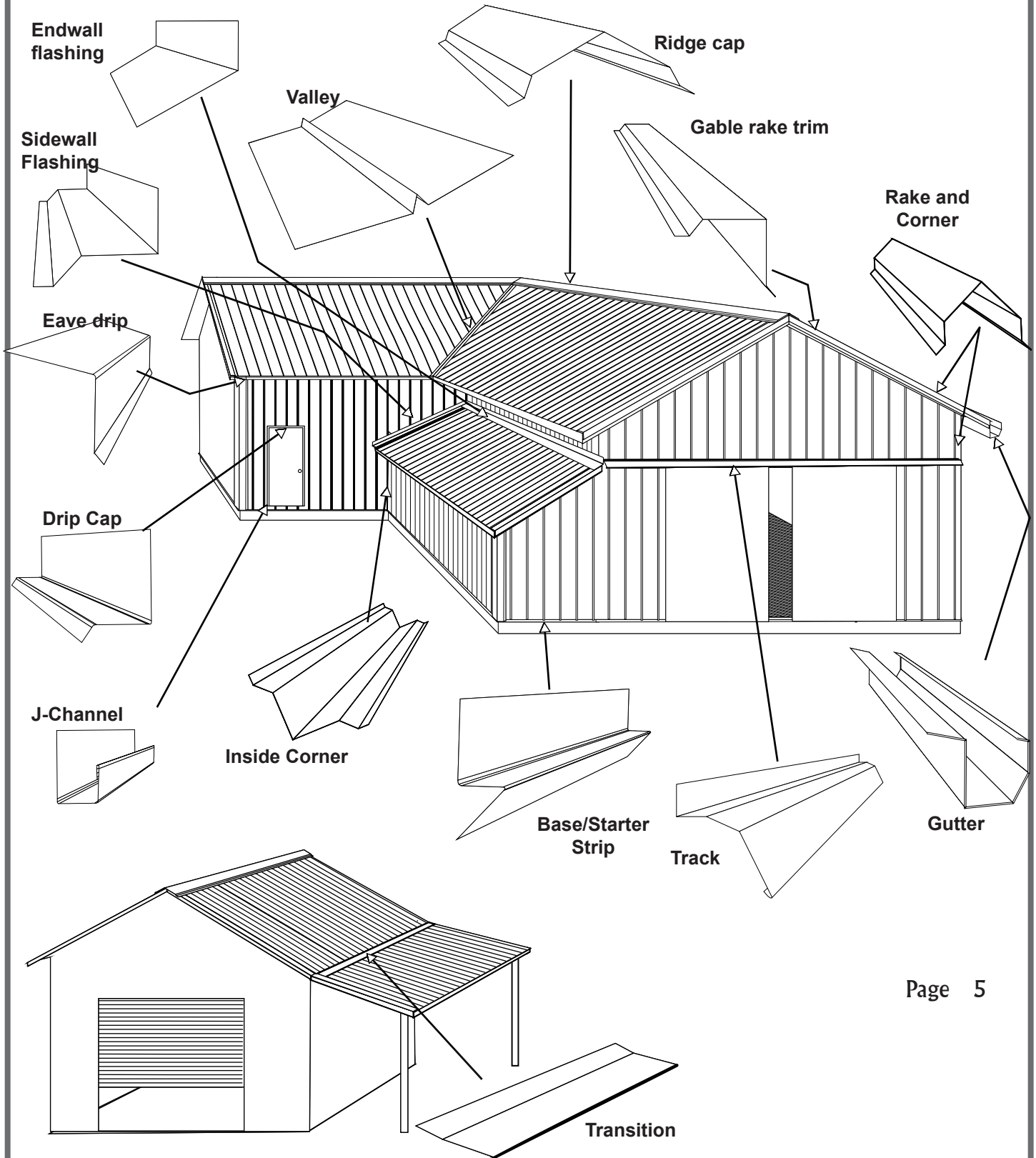



GENERAL ROOF APPLICATION

STEP 1 Capital Metal rib panels are easily installed by lapping the lap rib over the purlin rib. See the Capital Metal Supply roofing profile illustration on page 8 for lap and purlin rib clarification.

STEP 2 After installing the roof edge trim and roofing felt, install a layer of 3/4" sealant tape along the outside edge of the roof edge trim.

STEP 3 Prior to installing any panels, check the panel layout drawing for correct panel lengths for the various locations on the roof.

STEP 4 After consulting the panel drawing, measure in the specified distance from the starting rake. Use a chalk line to mark the decking or purlins the pre-measure distance.

STEP 5 Capital Metal Supply recommends that the installer measure a distance equal to four times the panel width away from the starting edge (rake) and marking this point by striking a chalk line from the ridge to the eave. You may wish to repeat this process every four panels to limit any panel drift.

STEP 6 Slide the first panel into place and align with the chalk line mark.

STEP 7 Fasten panel into place using the #10 x 1 1/2" metal to wood grip screws. Do not overdrive fasteners. Fastener spacing should never exceed the maximum allowable spacing as specified on the fastener selection table.

STEP 8 Install the next panel by positioning the panels lap rib over the purlin lap rib of the previous panel and align at eave end of panel, referencing previous panel and roof eave line. Once the panel is properly positioned, fasten the panel into place in the same manner as the first panel. Prior to fastening panels at the eave line, insert the foam eave closure and then fasten into place. Continue this process for all panels. *Any roof with less than a 3/12 pitch will require butyl tape to be applied to the entire length of the panel overlap. Lap screws will also be required.

STEP 9 Use the proper installation details for applying vents, pipes, skylights, chimneys and other commonly encountered obstacles.

STEP 10 Make sure that a straight line is maintained at the roof eave line. In order to accomplish this it is critical that the first panel is perpendicular to the eave line.

STEP 11 Refer to the "FRAME & PANEL FASTENER PATTERN" page for panel attachment at the eave and ridge ends of the panels. Before attaching the eave fasteners install the foam eave closures into position. The foam ridge closure must be put into place before installing the ridge cap.

STEP 12 Install trim and flashing according to installation details.

OVER EXISTING SHINGLE ROOF

29 GA. CAPITAL RIB PANEL FASTENER PATTERN AT 24" ON CENTER

Insert #10-15 x 1 1/2" ZAC HWH screws with rubber washers on 9"-9"-9"-9" centers as shown.

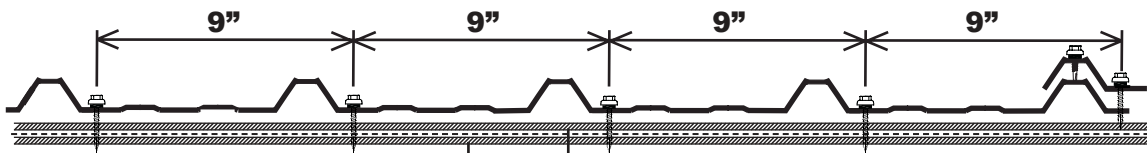

One layer of shingles over one layer of 30# felt over 7/16" OSB.

1" x 4" wood purlins at 24" on center attached to OSB with 8d x 2 1/2" ring shank nails at 4" on center.

Insert #10-15 x 1 1/2" ZAC HWH screws with rubber washers on 6"-3"-6"-3"-6"-3"-6"-3" centers as shown.

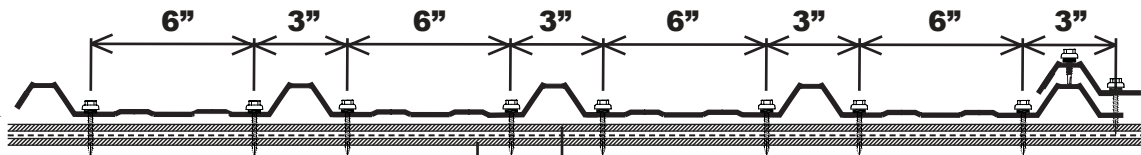

One layer of shingles over one layer of 30# felt over 7/16" OSB.

1" x 4" wood purlins at 24" on center attached to OSB with 8d x 2 1/2" ring shank nails at 4" on center and #9 x 3" deck screws at 24" on center to an engineered roof deck.

STEPS TO INSTALL

RIB PANEL *fastener pattern*



1" x 4" wood purlins at 24" on center
Shingles & felt over 7/16" OSB

TOP VIEW

Nail pattern for attaching purlins to roof. 8d x 2 1/2" ring shank nails offset at 4" on center.

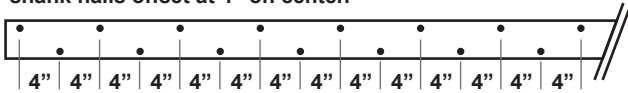

FRONT VIEW

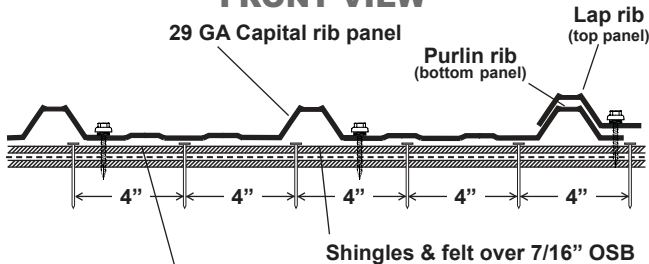

1" x 4" wood purlins at 24" on center attached to OSB with 8d x 2 1/2" ring shank nails at 4" on center.

29 GA Capital rib panel
Shingles & felt over 7/16" OSB
Insert #10-15 x 1 1/2" ZAC HWH screws with rubber washers. 8 per panel at ends.

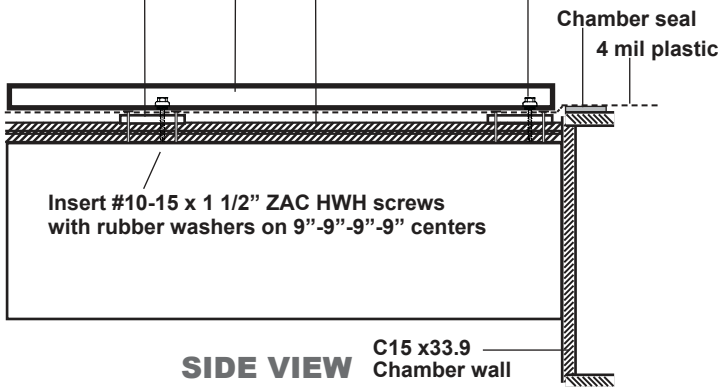

SIDE VIEW

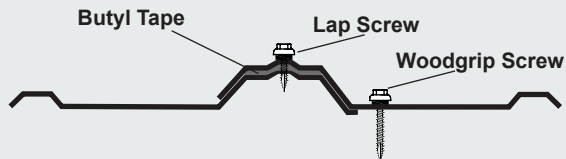

Any roof with less than a 3/12 pitch will require butyl tape to be applied to the entire length of the panel overlap. Lap screws will also be required.

FRAMING LAYOUT

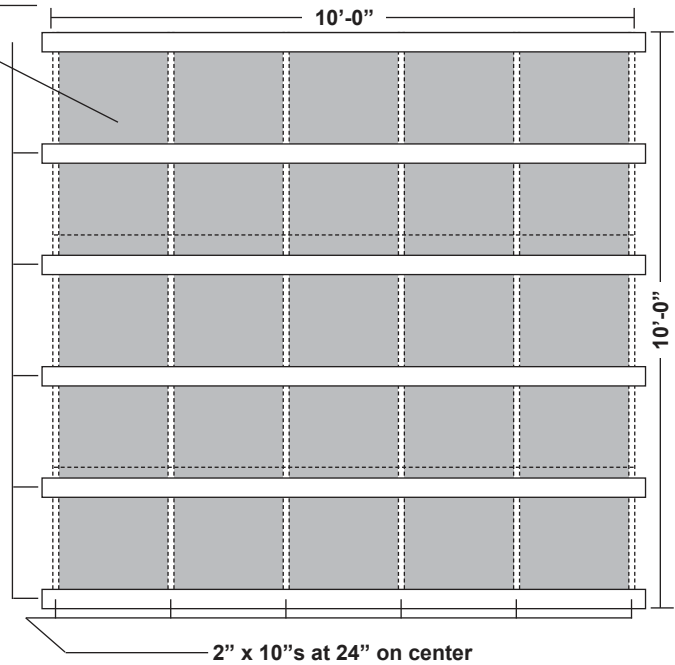

2" x 10"s at 24" on center

PANEL LAYOUT

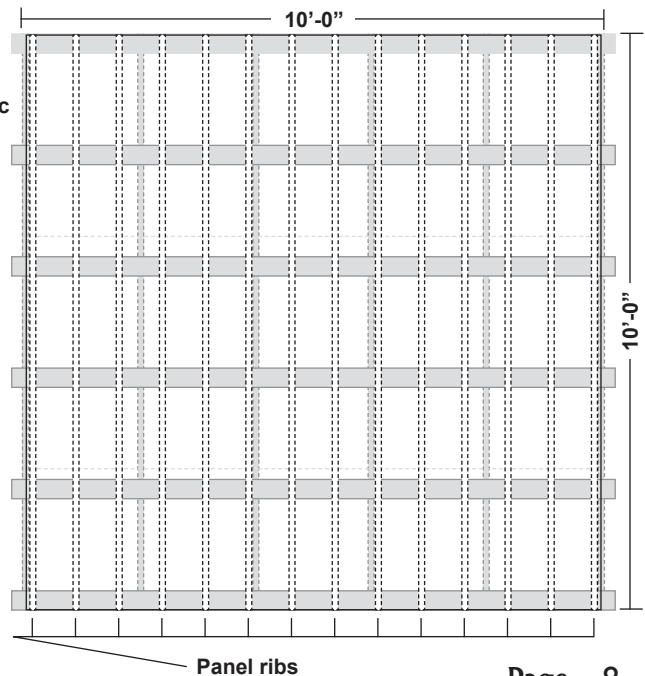

Panel ribs

FRAME & PANEL
fastener pattern



INSTALLATION SEQUENCE

Step 1 MOISTURE BARRIER -Install the moisture barrier according to the manufacturer's directions and recommendations.

Step 2 FASCIA-Install the fascia trim along all eaves and rakes.

Step 3 EAVE-Install the eave drip along all eaves. Overlap the fascia trim.

Step 4 VALLEY-Install the valley trim over the eave trim working from the eave to the valley peak.

Step 5 CAPITAL METAL RIB PANELS-Install the panels over the eave and valley trims. Do not install the panels where the ridge trim laps under the panels.

Step 6 HIP-Install the hip trim over the panels.

Step 7 RIDGE CAP-Install the ridge cap over the hip trim intersection and valley peak.

Step 8 TRANSITION-Install the transition trim over the low slope panels and the moisture barrier.

Step 9 CAPITAL METAL RIB PANELS-Finish the panel installation by installing the high slope panels over the trim transition and the other remaining exposed locations.

Step 10 GABLE RAKE-Install the rake trim over the panels along all rake edges.

Step 11 RIDGE CAP-Install the ridge cap trim over the panels.

Step 12 SIDE WALL-Install the side wall flashing over the panels.

Step 13 END WALL-Install the end wall flashing over the panels.

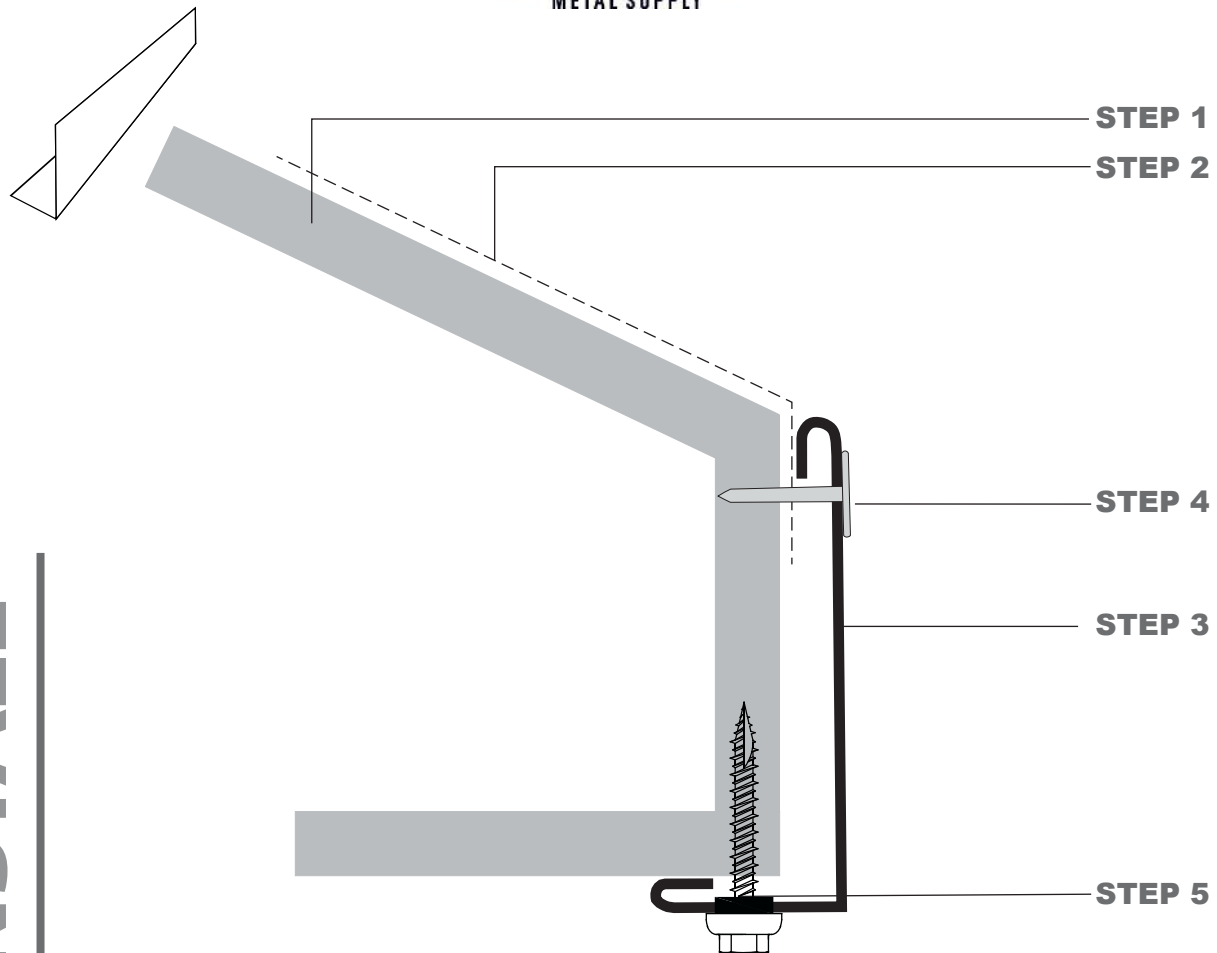

STEPS TO INSTALL

1. **Install the substrate according to local building code requirements.**
2. **Install the moisture barrier.**
3. **Install the fascia trim and overlap ends.**
4. **Fasten the trim with nails per local code along the length of the trim.**
5. **Fasten the trim with wood screws per local code along the length of the trim.**

FASCIA

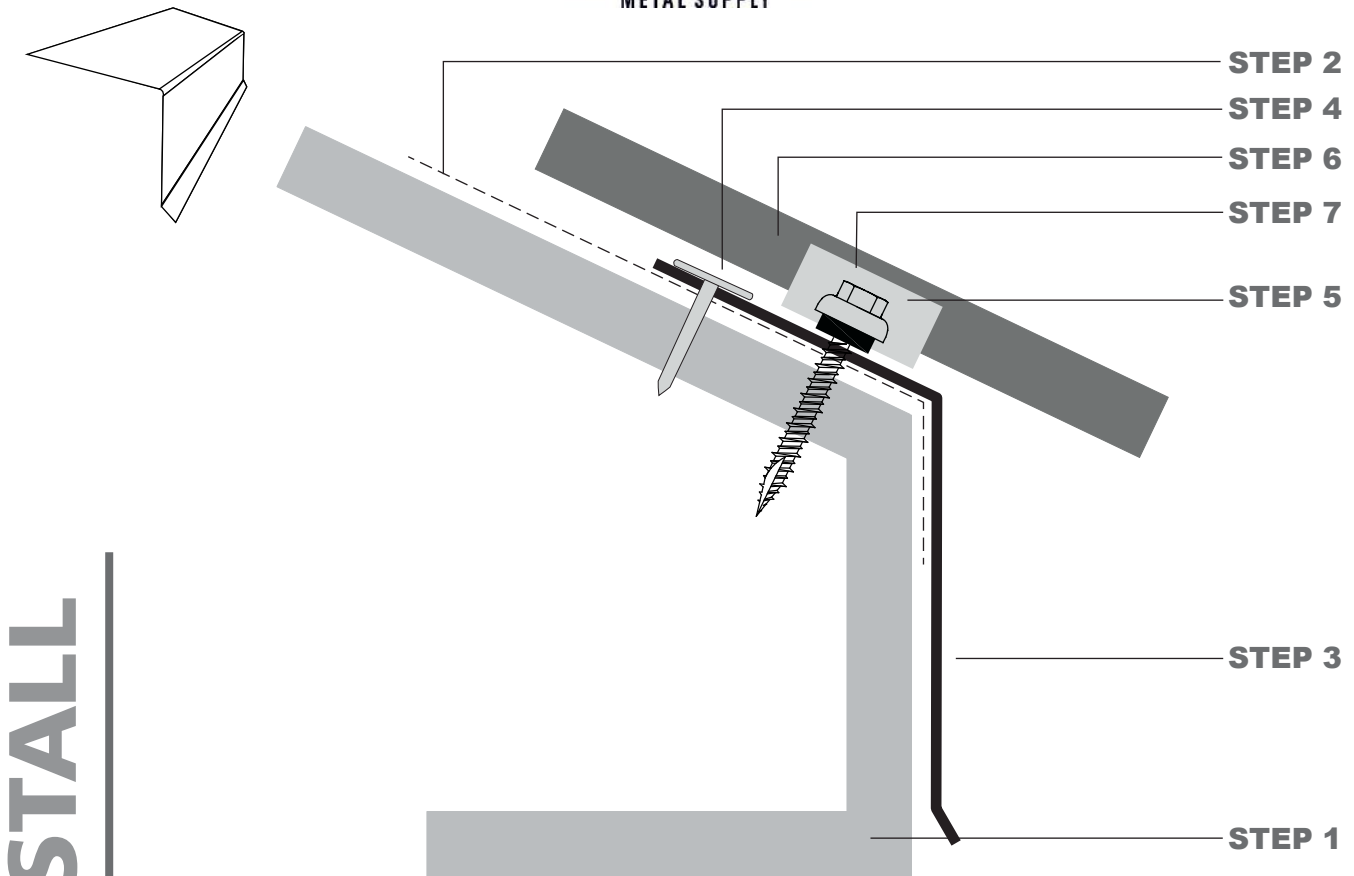

STEPS TO INSTALL

- 1. Install the substrate according to local building code requirements.**
- 2. Install the moisture barrier.**
- 3. Install the eave drip and overlap ends.**
- 4. Fasten the trim with nails per local codes apart along the length of the trim.**
- 5. Pull paper away from adhesive side of inner closure and apply closure to eave drip.**
- 6. Install the panel by overhanging a minimum of 1" past the eave drip edge.**
- 7. Fasten the panels to the roof substrate using metal to wood screws.**

EAVE DRIP

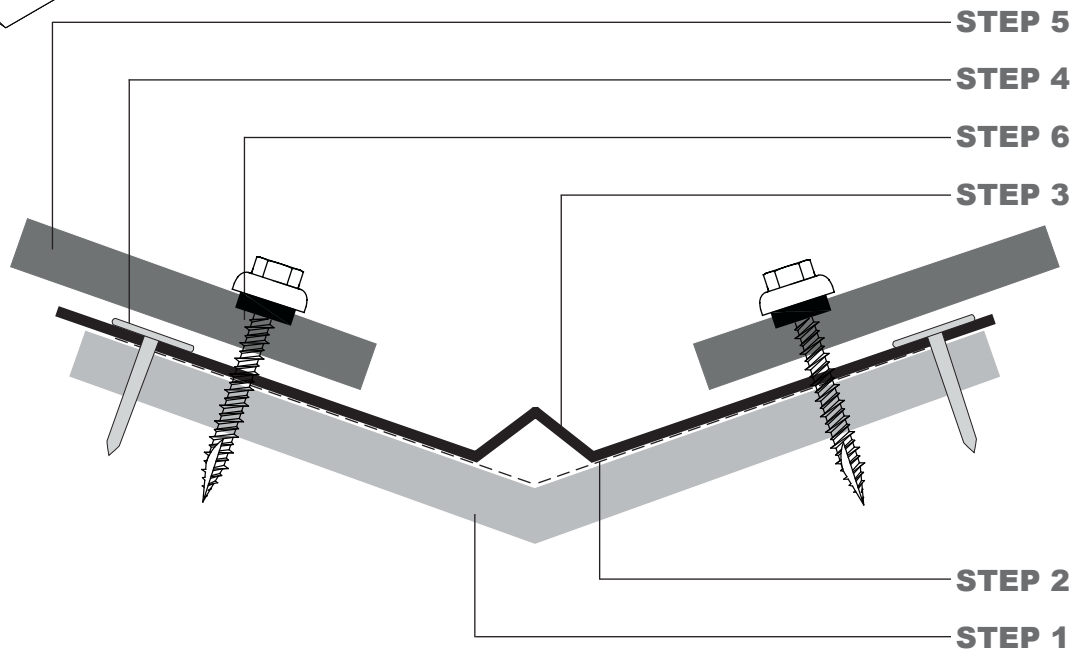
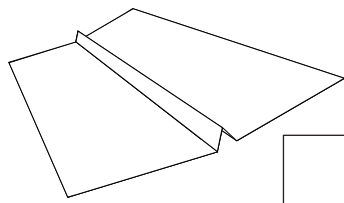

STEPS TO INSTALL

1. **Install the substrate according to local building code requirements.**
2. **Install the moisture barrier.**
3. **Install the valley trim and overlap the ends 4".**
4. **Fasten the trim with nails per local codes along the length of the trim.**
5. **Install the panel a minimum of 3" up from the water diverter at the bottom of the valley and minimum of 3" down from the top of the valley.**
6. **Fasten panels to the roof substrate using metal to wood screws as per the recommended fastening pattern.**

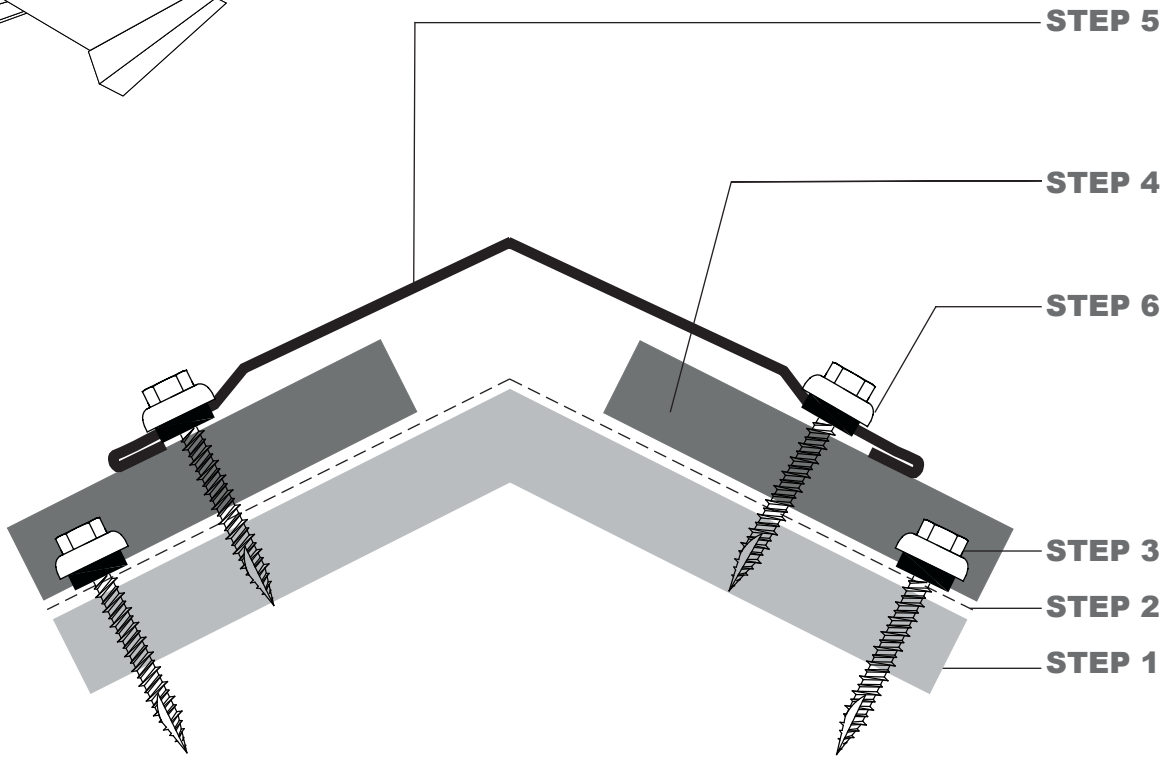
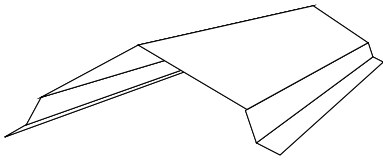

STEPS TO INSTALL

1. **Install the substrate according to local building code requirements.**
2. **Install the moisture barrier.**
3. **Install the panel by overhanging a minimum of 1" past the eave drip edge.**
4. **Fasten the panels to the roof substrate using metal to wood screws.**
5. **Place the hip cap over the panels.**
6. **Fasten the hip cap with metal to wood screws spaced 18" apart along the length of the trim, through the rib.**

HIP CAP

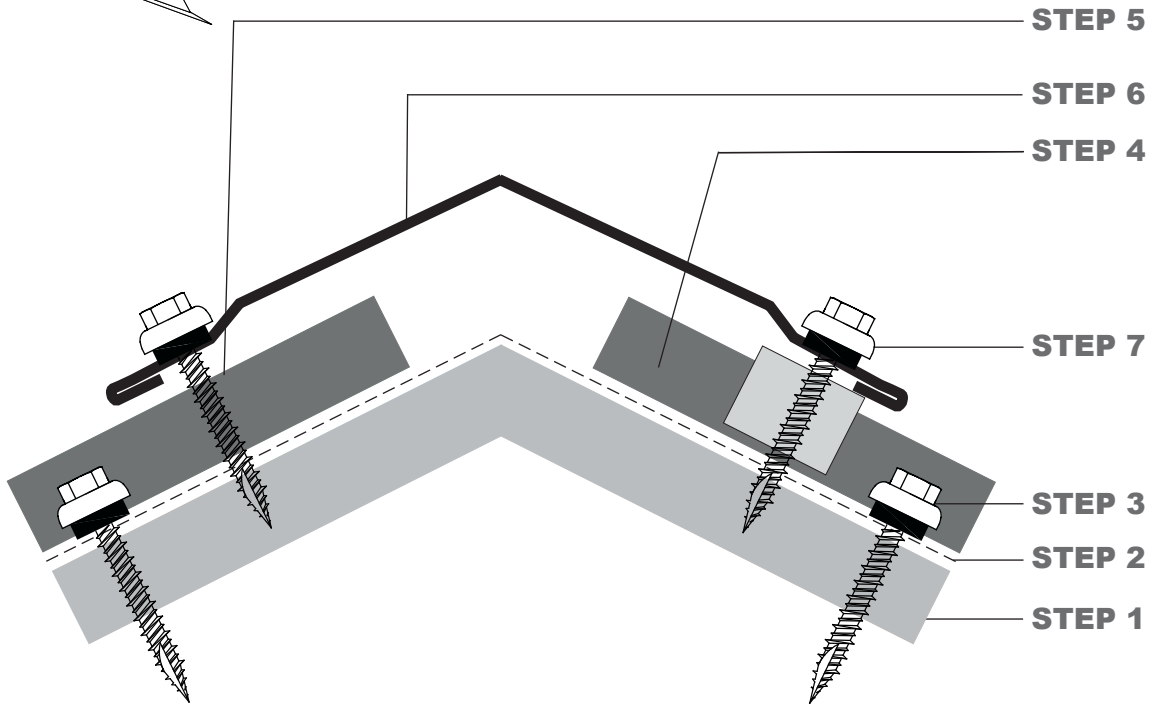
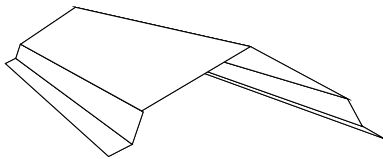

STEPS TO INSTALL

1. **Install the substrate according to local building code requirements.**
2. **Install the moisture barrier.**
3. **Install the panel by overhanging a minimum of 1" past the eave drip edge.**
4. **Fasten the panels to the roof substrate using metal to wood screws.**
5. **Pull paper away from adhesive side of outer closure and apply closure to underside of ridge cap.**
6. **Place the ridge cap onto the panels.**
7. **Fasten trim with metal to wood screws spaced 18" apart along the length of the trim, through the rib.**

RIDGE CAP

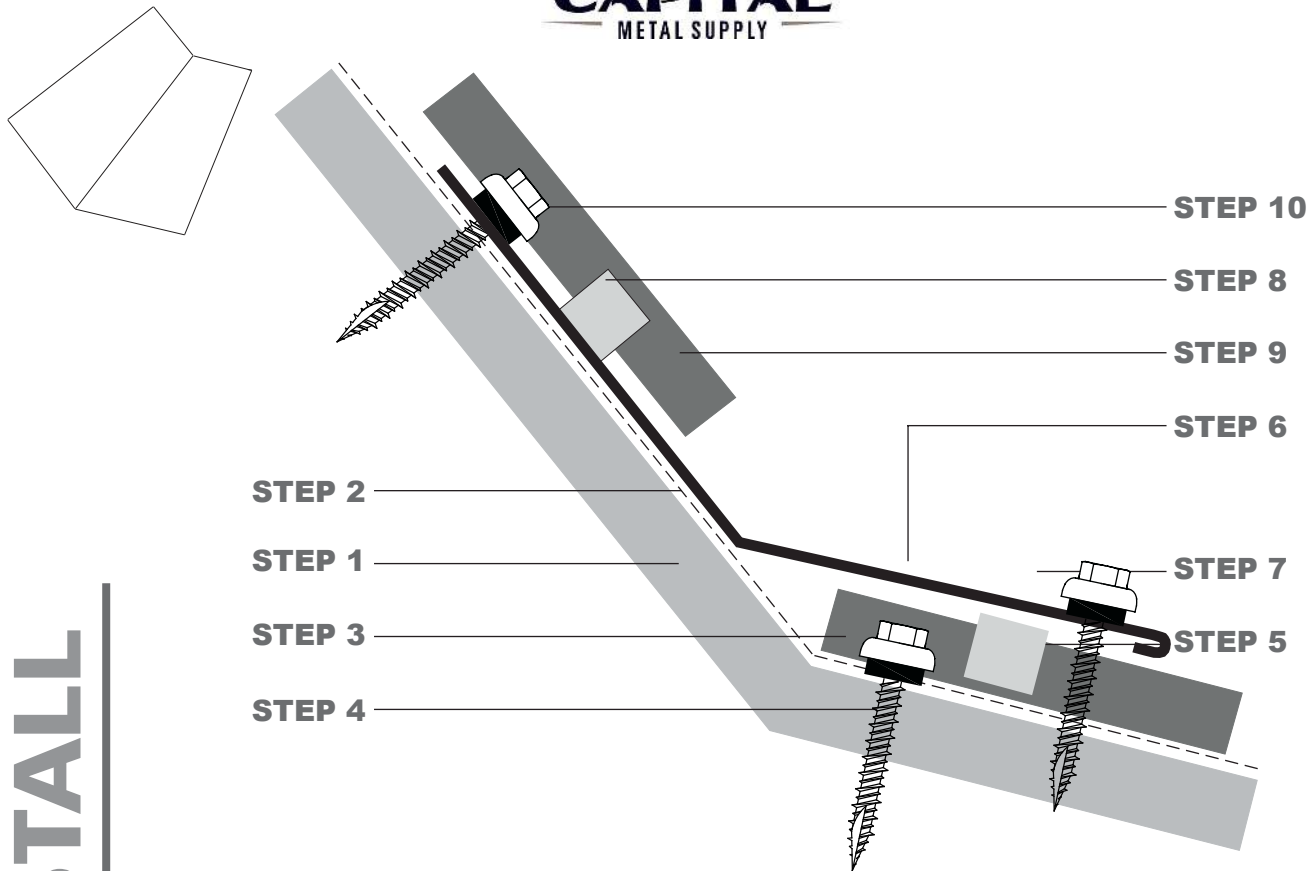

STEPS TO INSTALL

1. Install the substrate according to local building code requirements.
2. Install the moisture barrier.
3. Install the panel. Overhang the panel 1" beyond the eave edge.
4. Fasten panel to roof substrate using metal to wood screws.
5. Pull paper away from adhesive side of outer closure and apply closure across the width of the panel.
6. Place the roof pitch transition over the outside closure.
7. Fasten trim with metal to wood screws space 18" apart along the length of the trim, through the rib.
8. Pull paper away from adhesive side of inner closure and apply closure across the width of the panel, 1" up from the panel end.
9. Install the panel up 1" from the transition bend.
10. Fasten panel to roof substrate using metal to wood screws.

TRANSITION

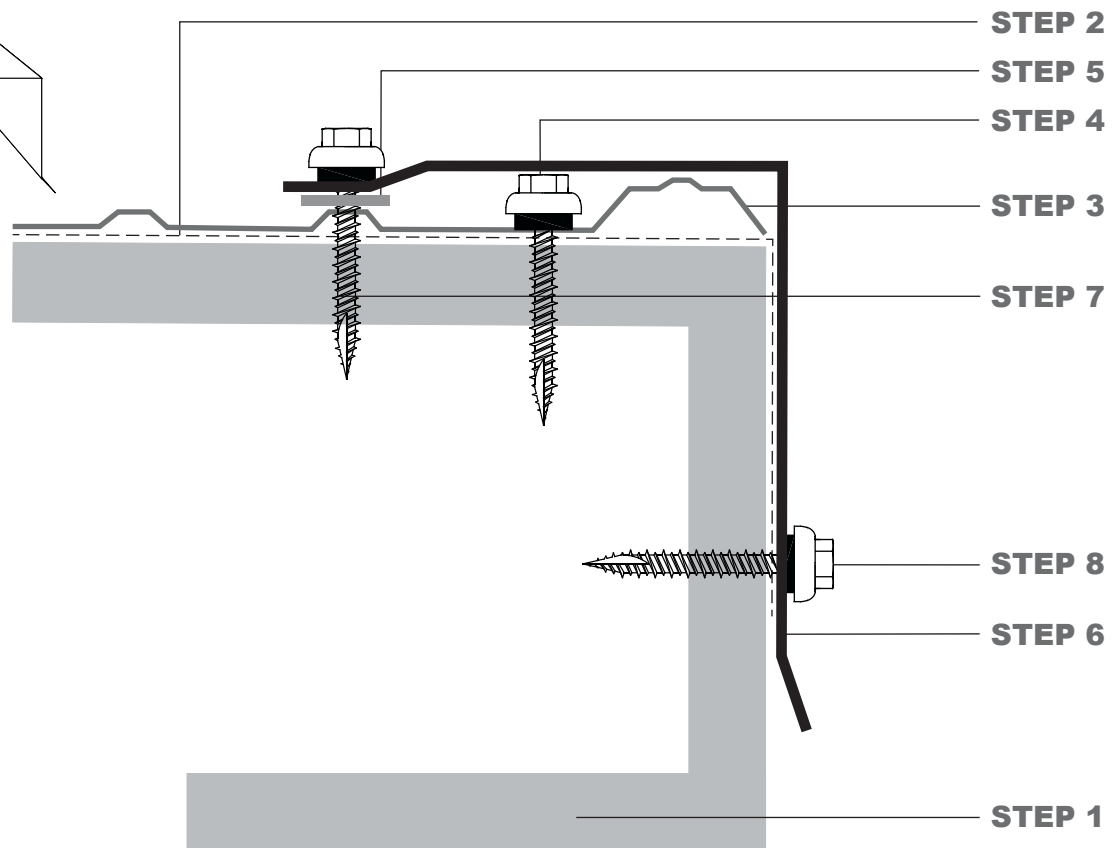
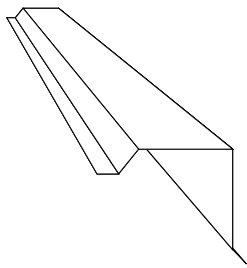

STEPS TO INSTALL

1. **Install the substrate according to local building code requirements.**
2. **Install the moisture barrier.**
3. **Install the panel by overhanging a minimum of 1" past the eave drip edge.**
4. **Fasten the panels to the roof substrate using metal to wood screws.**
5. **Apply butyl tape along the length of the panel.**
6. **Install the rake trim and overlap the ends 4".**
7. **Fasten trim with metal to wood screws spaced 2' apart along the length of the trim.**
8. **Fasten trim with metal to wood screws spaced 2' apart along the length of the trim.**

GABLE RAKE

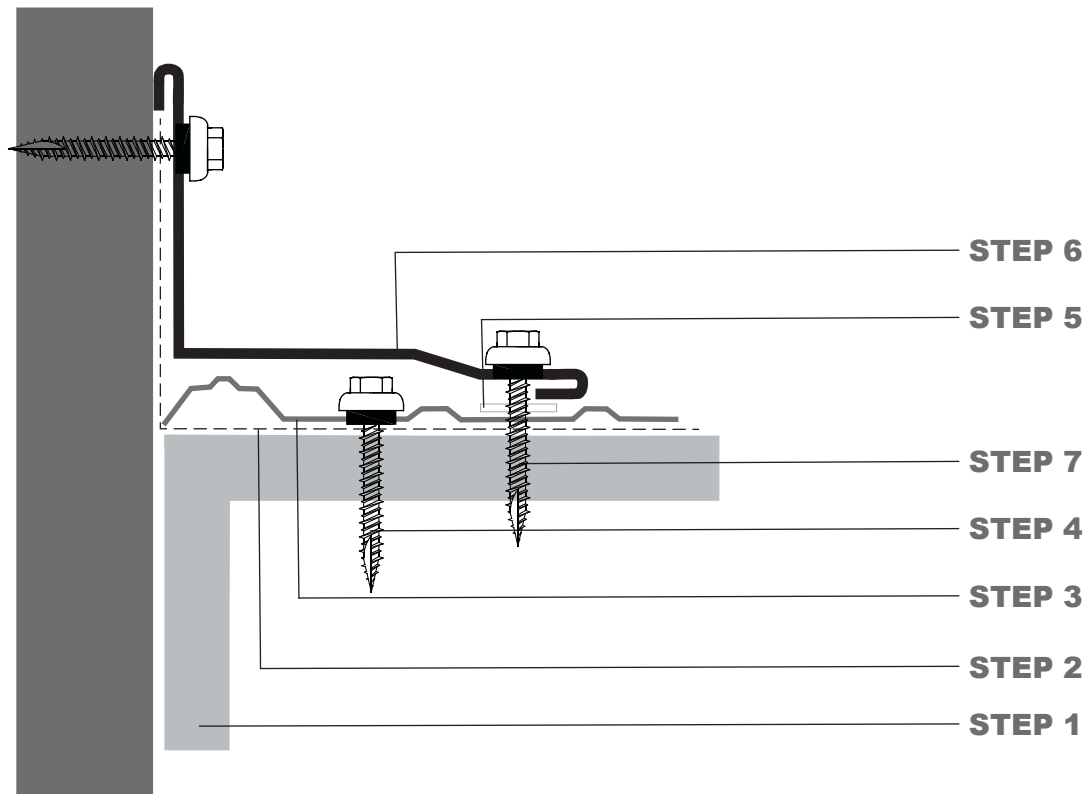
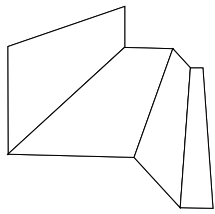

STEPS TO INSTALL

1. **Install the substrate according to local building code requirements.**
2. **Install the moisture barrier.**
3. **Install the panel, allowing the panel to overhang beyond the eave drip edge a minimum of 1".**
4. **Fasten the panels to the roof substrate using metal to wood screws.**
5. **Apply butyl tape along the length of the panel.**
6. **Place the side wall trim over the butyl tape and overlap the ends 4".**
7. **Fasten the trim with metal to wood screws spaced 2' apart along the length of the trim.**
8. **Fasten the trim with metal to wood screws spaced 2' apart along the length of the trim.**

SIDE WALL

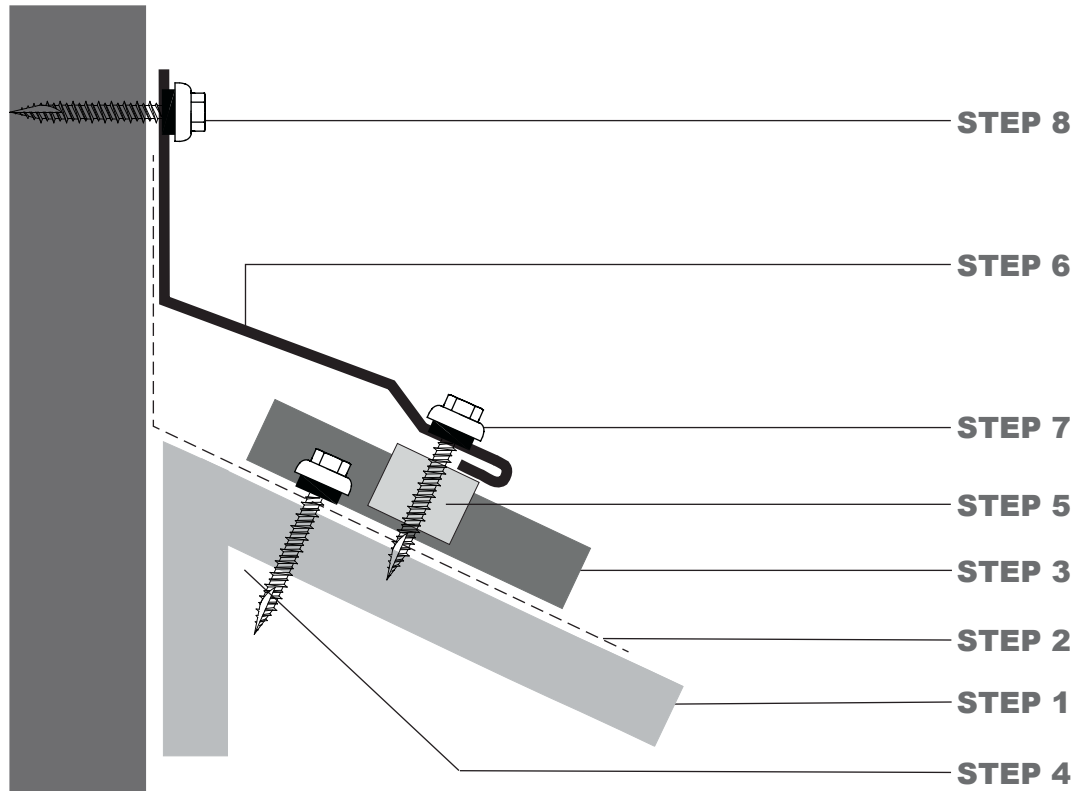
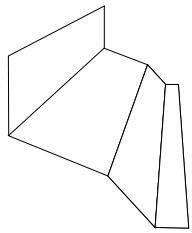

STEPS TO INSTALL

1. **Install the substrate according to local building code requirements.**
2. **Install the moisture barrier.**
3. **Install the panel, allowing the panel to overhang beyond the eave drip edge a minimum of 1".**
4. **Fasten the panels to the roof substrate using metal to wood screws.**
5. **Pull paper away from adhesive side of outer closure and apply closure to panel.**
6. **Place the end wall trim over the outer closure and over lap the ends 4".**
7. **Fasten the trim with wood screws spaced 18" apart along the length of the trim, through the rib.**
8. **Fasten the trim with metal to wood screws spaced 2' apart along the length of the trim.**

END WALL

Cut pipe flashing along the pipe diameter marking.

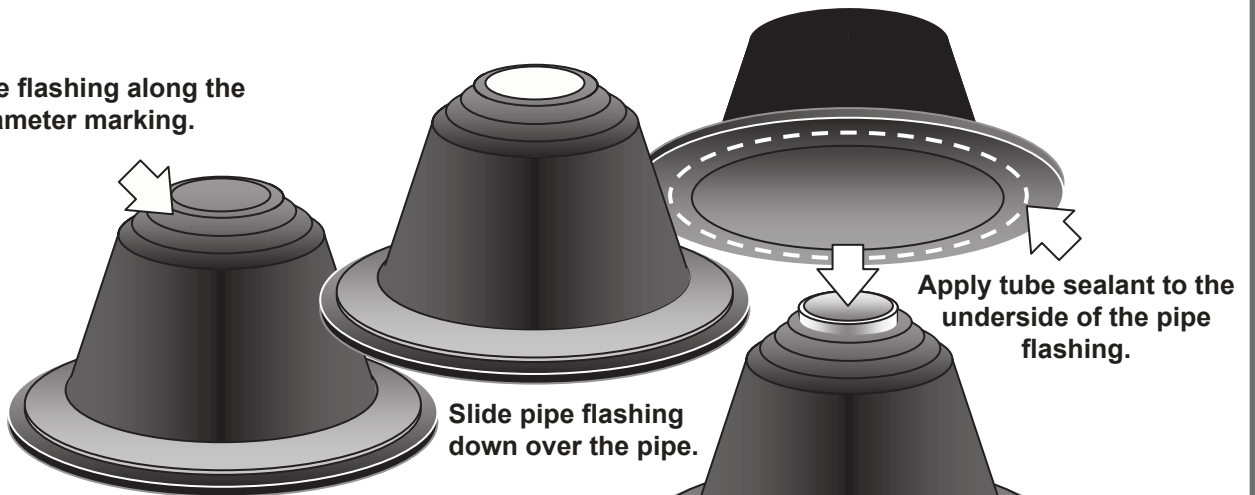

STEPS TO INSTALL

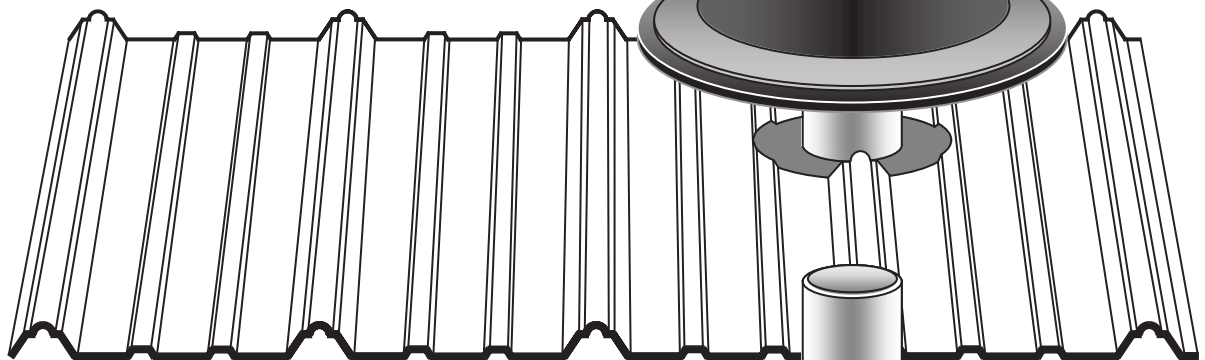

Press the pipe flashing into contours of panel configuration and fasten to the Capital rib panel with metal to wood screws. Apply additional sealant around base if desired.

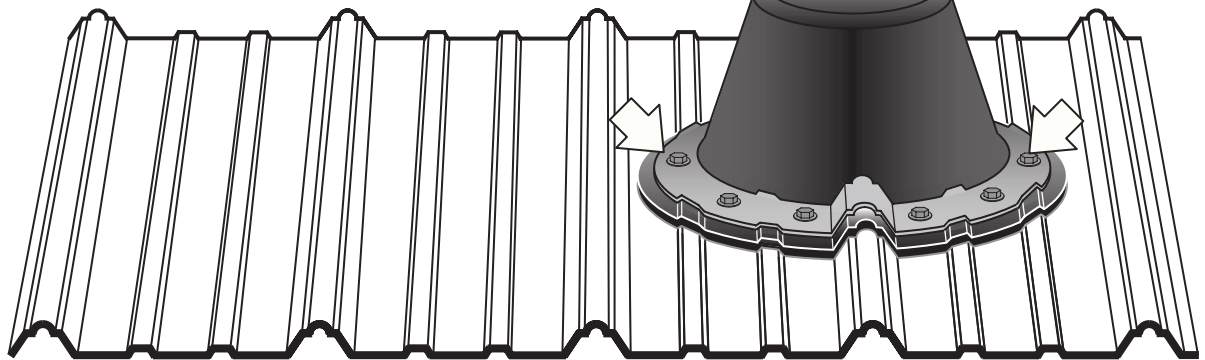

PIPE FLASHING



Pop Rivet
(stainless)
(1/8" x 3/16")



#10 x 2" Hex Head
ZAC HWH metal to
wood screws with
rubber washers



#10 x 1-1/2" Hex Head
ZAC HWH metal to wood
screws with rubber
washers



#14 x 7/8" Hex Head
ZAC HWH metal to metal
screws with rubber washers



2" Wood Grip Hex
Head screws with
rubber washers



1 1/2" Wood Grip
Hex Head screws
with rubber washers



7/8" Hex Head metal
to metal wood grip
screws with rubber
washers

ASSORTED HARDWARE



Emseal Expandable
Universal Closure



Universal
Vented Closure



Single Bead
Butyl Tape



Pipe Boot
heat treated
&
retro fit also available)

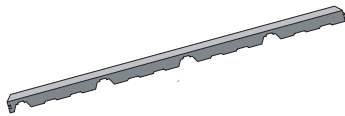

Outside Closure
Foam Strip



Vented Closure
Strip

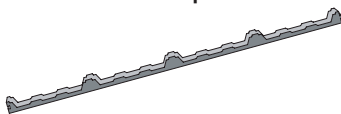

Inside Closure
Foam Strip



Touch Up Paint
w/ Brush
(.6 oz)



Tube Sealant
(10.3 oz)

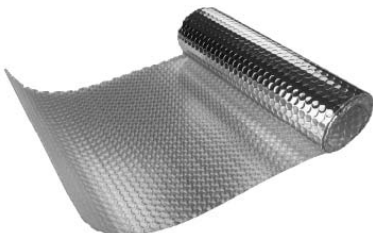

Bubble Insulation



Radiant Barrier



Synthetic
Roof Underlayment

ACCESSORIES

**OUTSIDE CLOSURES**

Seals under ridge caps and transition and end wall flashings.

INSIDE CLOSURES

Seals under panels, particularly on the eave.

EXPANDING FOAM

Compressed adhesive foam expands to seal between valleys and panels.

TOUCH UP PAINT

Hides scratches and mars encountered in installation.

BUTYL TAPE

General purpose low-cost sealant, used on panel laps and under trim.

TUBE SEALANT

A superior general purpose caulk for all joints. Matches panel colors.

WOOD GRIP METAL TO METAL SCREWS

Used in all applications attaching metal to metal. Used to draw together joints and attach trim.

ZAC HWH METAL TO METAL SCREWS

Used in all applications attaching metal to metal. Used to draw together joints and attach trim.

WOOD GRIP SCREWS

Self-piercing hex head screws for metal to wood purlins. Screws draw together joints and attach trim.

ZAC HWH METAL TO WOOD SCREWS

Self-piercing hex head screws for metal to wood purlins. Lap TEK screws draw together joints and attach trim. 1", 1½", 2" sizes.

PIPE BOOT

Fits over vent and heat pipes. Available also in heat-resistant boots.

POP RIVETS

Used for attaching metal to metal.

RADIANT BARRIER

Insulation that inhibits heat transfer by thermal radiation.

BUBBLE INSULATION

Insulation that forms an air barrier between the roof deck & rib roofing.

ASSORTED HARDWARE

ACCESSORIES

notes

notes

